



2025  
LIGHTING CATALOGUE







**NANOLED LIGHTING**

It is a brand of Tecnocavi Service srl  
61021 Carpegna (PU) via Pian dei Roghi, 32  
Tel. + 39 0722 77418  
[info@nanoledlighting.com](mailto:info@nanoledlighting.com)  
[www.nanoledlighting.com](http://www.nanoledlighting.com)

*Our research and knowledge leads us time and time again to experiment with new forms of lighting and to supply our customers with quality products that last.*

NANOLED LIGHTING is the lighting brand belonging to Tecnocavi Service, an Italian company founded in 1994 that has been producing and marketing LED lights nationally and internationally since 2003.

The aim of NANOLED LIGHTING is to offer lighting specialists, the furniture industry, architects and interior design contractors targeted, reliable and high-quality LED lighting solutions as they are exclusively manufactured in Italy by qualified craftsmen. NANOLED LIGHTING selects reliable suppliers and quality materials to make its lights, so that the finished product provides the user with long-lasting use.

Thanks to its own equipment and production facilities, NANOLED LIGHTING can process aluminium, steel and polycarbonate, and assemble electronic boards.

This offers a great advantage to architects and designers who also have the possibility of customising and adapting products to their clients' broader needs.

The exponential development of LED technology has also highlighted photobiological issues, and NANOLED LIGHTING - considering this aspect that is fundamental for people's health and in some cases also for environmental protection - offers sustainable and ecodesign-compliant products.

Lastly, NANOLED LIGHTING provides and accompanies its partners with all the photometric, technical and commercial support needed to integrate its lighting systems into a wide variety of projects. 100% of the products are checked and tested before being shipped. The company's entire production system is accredited by the European body IMQ, which periodically checks that all procedures adopted are up to date and comply with ISO9001:2015 certification.







# INDEX BY PRODUCT FAMILY

## MICROSPOT

DUST	16
DUST KIT	17
SKY	18
SKY KIT	19
ALGOL	20
HALLEY	21

## INDOOR FLUSH FITTINGS

MINI VESTA	24
EOS	25
EOS Q	26
EOS CEILING LIGHT	27
EOS W	28
EOS W Q	29
EOS METAL	30
EOS METAL Q	31
IRIDE W	32
ZEFIRO W	33
VALLY	34
GIORDAN	35
GIORDAN CEILING LIGHT	36
TICHE	37
TICHE CEILING LIGHT	38
TICHE Q	39
TICHE Q CEILING LIGHT	40
TICHE MAXI	41
BASIK 1	42
BASIK Q	43
BIONIK 1	44
BIONIK Q	45
SIMPLE	46
SIMPLE Q	47
SIMPLE M	48
SIMPLE M Q	49
SIMPLE W	50
FOUR HOLE	51

FOUR HOLE Q	52
EGO METAL	53
EGO METAL Q	54
REMOVE PLUS	55
REMOVE MINUS	56
PAD	57
ERMA	58

## INDOOR AND OUTDOOR RECESSED LIGHTS

REMOVE PLUS WP	62
HOLLY	63
HALISSA	64
MEMO	65
DEHO 2	66
DEHO 3	67
DEHO 4	68
DEHO 5	69
DEHO Q	70
DARDO 2	71
DARDO 3	72
DARDO Q	73
ACSO 1	74
ACSO 2	75
ACSO 3	76
ACRUX 1	77

## 316 L RECESSED LIGHTS

DEHO 1 L	80
DEHO 1 L Q	81
DEHO 2 L	82
DEHO 3 L	83
DEHO 4 L	84
DEHO 5 L	85
DEHO Q L	86



# INDEX BY PRODUCT FAMILY

## LINEAR WALL SYSTEMS

KAPPA 1	198
JEY 5	200

## DIRECTIONAL LINEAR SYSTEMS

DIRECTIONAL RHO	204
DIRECTIONAL DELTA	206

## FLOOR LINEAR SYSTEM

YPSILON FLOOR LIGHT	210
---------------------	-----

## RGB SYSTEMS

SKY RGB	214
ALGOL RGB	215
HALLEY RGB	216
EOS RGB	217
BASIK 1 RGB	218
BASIK Q RGB	219
BIONIK 1 RGB	220
BIONIK Q RGB	221
FOUR HOLE RGB	222
FOUR HOLE Q RGB	223
DEHO 2 RGB	224
DEHO Q RGB	225
ACSO 1 RGB	226
VERTIGO RGB	227
DUVAR RGB	228

## POWER SUPPLIES

350mA CONSTANT CURRENT	232
500mA CONSTANT CURRENT	233
CONSTANT CURRENT FOR COB	234
MULTICURRENT	235
CONSTANT VOLTAGE 12Vdc	236
CONSTANT VOLTAGE 24Vdc	237
CONSTANT VOLTAGE 24Vdc DALI2 AND PUSH	239
EMERGENCY DEVICE	241

## CONNECTION SYSTEMS

SERIES CONNECTION	244
PARALLEL CONNECTION	245
SERIES-PARALLEL CONNECTION	246
RGB CONNECTION	247

## CONTROL SYSTEMS

SK-V1 CONTROL UNIT	250
RF.001 CONTROL UNIT	251
SR-1029 CONTROL UNIT	252
RFL20K CONTROL UNIT	253
SR-1029W CONTROL UNIT	254
1009FA3 CONTROL UNIT	255
DLM1224-1CV CONTROL UNIT	256
MINI-1CV CONTROL UNIT	257
MINI-1CV-DALI CONTROL UNIT	258
MINI-1CV-CASAMBI CONTROL UNIT	259
LINE-5CV CONTROL UNIT	260
DLX1224-4CV-DALI CONTROL UNIT	261
LINE 5CV-CASAMBI CONTROL UNIT	262
DLC1248-1CC350 CONTROL UNIT	263
DLC1248-1CC500 CONTROL UNIT	263
DLX1224-4CC350 CONTROL UNIT	264
DLX1224-4CC500 CONTROL UNIT	264
VOLUMETRIC SENSOR	265
INFRARED SENSOR	265
TOUCH SENSOR	265
TOUCH MINI SENSOR	266
TOUCH DIMMER SENSOR	266
MINI MOTION DETECTOR SENSOR	267
TOUCH SENSOR SWITCH SENSOR	267
IR SENSOR SWITCH SENSOR	267

# INDEX BY PRODUCT FAMILY

## PROJECTORS

DUVAR	90
VERTIGO	91
ZEPPELIN	92

## DECORATIVE TECHNICAL LIGHTING

PIXEL 1	96
ROMY	97
SARY	98
ISA	99
LILLY	100
EVA	101
LINEA	102
QUADRA Q1	103
QUADRA Q2	104
QUADRA Q3	105
QUADRA Q4	106
QUADRA R1	107
QUADRA R2	108
QUADRA R3	109
REM	110
CISO P31 CEILING LIGHT	111
CISO P33 CEILING LIGHT	112
CISO P50 CEILING LIGHT	113
CISO P80 CEILING LIGHT	114
CISO S31 PENDANT LIGHT	115
CISO S33 PENDANT LIGHT	116
CISO S50 PENDANT LIGHT	117
CISO S80 PENDANT LIGHT	118
CEILING ROSES FOR OTHER CISO COMPOSITIONS	119

## LINEAR FLUSH-MOUNTED SYSTEM

EPTA	122
SIGMA	124
REFLEX	126
IOTA	128

RASO	130
RHO 1	132
YPSILON 1	134
DELTA 3	136
TAU	138
MILKY	140

## CEILING-MOUNTED OR FLUSH-MOUNTED LINEAR SYSTEMS

MINI	144
JEY 1	146
JEY 2	148
ZETA 1	150
ZETA 2	152
RHO 3	154
VELA 1	156
VELA 2	158
GAMMA	160
VEGA	162
BETA	164
DELTA 1	166
KAPPA 3	168
QU	170
H1	172
H2	174
H3	176
C1	178
C2	180

## LINEAR PENDANT SYSTEMS

JEY PENDANT	184
MAGNETIC JEY PENDANT	186
RHO PENDANT	188
DELTA PENDANT	190
KAPPA PENDANT	192
MAGNETIC KAPPA PENDANT	194



# INDEX BY PRODUCT FAMILY

## INSTALLATION ACCESSORIES

HOLLY, HALISSA AND MEMO FORMWORK .....	270
ACSO AND ACRUX SERIES FORMWORK .....	270
ACSO AND ACRUX SERIES RING .....	270
DEHO AND DARDO SERIES FORMWORK .....	271
DEHO AND DARDO SERIES RING .....	271
PAD FORMWORK .....	271
REMOVE PLUS FORMWORK .....	272
REMOVE MINUS FORMWORK .....	272
DUVAR BASE AND STAKE .....	272

## COMPLEMENTARY SYSTEMS

REM COMPLEMENTARY SYSTEMS .....	276
DARK COMPLEMENTARY SYSTEMS .....	276

# ALPHABETICAL INDEX

12Vdc CONSTANT VOLTAGE POWER SUPPLIES	236
24Vdc CONSTANT VOLTAGE POWER SUPPLIES	237
24Vdc DALI2 and PUSH CONSTANT VOLTAGE POWER SUPPLIES	239
350mA CONSTANT CURRENT POWER SUPPLIES	232
500mA CONSTANT CURRENT POWER SUPPLIES	233

## A

ACRUX 1	77
ACSO 1 RGB	226
ACSO 1	74
ACSO 2	75
ACSO 3	76
ACSO AND ACRUX SERIES FORMWORK	270
ACSO AND ACRUX SERIES RING	270
ALGOL RGB	215
ALGOL	20

## B

BASIK 1 RGB	218
BASIK 1	42
BASIK Q RGB	219
BASIK Q	43
BETA	164
BIONIK 1 RGB	220
BIONIK 1	44
BIONIK Q RGB	221
BIONIK Q	45

## C

C1	178
C2	180
CEILING ROSES FOR OTHER CISO COMPOSITIONS	119
CISO P31 CEILING LIGHT	111
CISO P33 CEILING LIGHT	112
CISO P50 CEILING LIGHT	113
CISO P80 CEILING LIGHT	114
CISO S31 PENDANT LIGHT	115
CISO S33 PENDANT LIGHT	116
CISO S50 PENDANT LIGHT	117

CISO S80 PENDANT LIGHT	118
CONSTANT CURRENT POWER SUPPLIES FOR COB	234

## D

DARDO 2	71
DARDO 3	72
DARDO Q	73
DARK COMPLEMENTARY SYSTEMS	276
DEHO 1 L Q	81
DEHO 1 L	80
DEHO 2 L	82
DEHO 2 RGB	224
DEHO 2	66
DEHO 3 L	83
DEHO 3	67
DEHO 4 L	84
DEHO 4	68
DEHO 5 L	85
DEHO 5	69
DEHO AND DARDO SERIES FORMWORK	271
DEHO AND DARDO SERIES RING	271
DEHO Q L	86
DEHO Q RGB	225
DEHO Q	70
DELTA 1	166
DELTA 3	136
DELTA PENDANT	190
DIRECTIONAL DELTA	206
DIRECTIONAL RHO	204
DLC1248-1CC350 CONTROL UNIT	263
DLC1248-1CC500 CONTROL UNIT	263
DLM1224-1CV CONTROL UNIT	256
DLX1224-4CC350 CONTROL UNIT	264
DLX1224-4CC500 CONTROL UNIT	264
DLX1224-4CV-DALI CONTROL UNIT	261
DUST KIT	17
DUST	16
DUVAR BASE AND STAKE	272
DUVAR RGB	228
DUVAR	90



# ALPHABETICAL INDEX

<b>E</b>	
EGO METAL Q	54
EGO METAL	53
EMERGENCY DEVICES	241
EOS CEILING LIGHT	27
EOS METAL Q	31
EOS METAL	30
EOS Q	26
EOS RGB	217
EOS W Q	29
EOS W	28
EOS	25
EPTA	122
ERMA	58
EVA	101
<b>F</b>	
FOUR HOLE Q RGB	223
FOUR HOLE Q	52
FOUR HOLE RGB	222
FOUR HOLE	51
<b>G</b>	
GAMMA	160
GIORDAN CEILING LIGHT	36
GIORDAN	35
<b>H</b>	
H1	172
H2	174
H3	176
HALISSA	64
HALLEY RGB	216
HALLEY	21
HOLLY	63
HOLLY, HALISSA AND MEMO FORMWORK	270
<b>I</b>	
INFRARED SENSOR	265
IOTA	128
IR SENSOR SWITCH SENSOR	267
IRIDE W	32
ISA	99
<b>J</b>	
JEY 1	146
JEY 2	148
JEY 5	200
JEY PENDANT	184
<b>K</b>	
KAPPA 1	198
KAPPA 3	168
KAPPA PENDANT	192
<b>L</b>	
LILLY	100
LINE 5CV-CASAMBI CONTROL UNIT	262
LINE-5CV CONTROL UNIT	260
LINEA	102
<b>M</b>	
MAGNETIC JEY PENDANT	186
MAGNETIC KAPPA PENDANT	194
MEMO	65
MILKY	140
MINI MOTION DETECTOR SENSOR	267
MINI VESTA	24
MINI	144
MINI-1CV CONTROL UNIT	257
MINI-1CV-CASAMBI CONTROL UNIT	259
MINI-1CV-DALI CONTROL UNIT	258
MULTI-CURRENT POWER SUPPLIES	235
<b>P</b>	
PAD FORMWORK	271
PAD	57
PARALLEL CONNECTION ACCESSORIES	245
PIXEL 1	96

# ALPHABETICAL INDEX

<b>Q</b>			
QU	170	SKY RGB	214
QUADRA Q1	103	SR-1009FA3 CONTROL UNIT	255
QUADRA Q2	104	SR-1029 CONTROL UNIT	252
QUADRA Q3	105	SR-1029W CONTROL UNIT	254
QUADRA Q4	106		
QUADRA R1	107	<b>T</b>	
QUADRA R2	108	TAU	138
QUADRA R3	109	TICHE CEILING LIGHT	38
		TICHE MAXI	41
<b>R</b>		TICHE Q CEILING LIGHT	40
RASO	130	TICHE Q	39
REFLEX	126	TICHE	37
REM COMPLEMENTARY SYSTEMS	276	TOUCH DIMMER SENSOR	266
REM	110	TOUCH MINI SENSOR	266
REMOVE MINUS FORMWORK	272	TOUCH SENSOR SWITCH SENSOR	267
REMOVE MINUS	56	TOUCH SENSOR	265
REMOVE PLUS FORMWORK	272		
REMOVE PLUS WP	62	<b>V</b>	
REMOVE PLUS	55	VALLY	34
RF.001 CONTROL UNIT	251	VEGA	162
RFL20K CONTROL UNIT	253	VELA 1	156
RGB CONNECTION ACCESSORIES	247	VELA 2	158
RHO 1	132	VERTIGO RGB	227
RHO 3	154	VERTIGO	91
RHO PENDANT	188	VOLUMETRIC SENSOR	265
ROMY	97		
		<b>Y</b>	
<b>S</b>		YPSILON 1	134
SARY	98	YPSILON FLOOR LIGHT	210
SERIES CONNECTION ACCESSORIES	244		
SERIES-PARALLEL CONNECTION ACCESSORIES	246	<b>Z</b>	
SIGMA	124	ZEFIRO W	33
SIMPLE M Q	49	ZEPELIN	92
SIMPLE M	48	ZETA 1	150
SIMPLE Q	47	ZETA 2	152
SIMPLE W	50		
SIMPLE	46		
SK-V1 CONTROL UNIT	250		
SKY	18		
SKY KIT	19		



# SYMBOLS



Product compliant with European Electrical Safety Regulations.



Product subject to European WEEE regulations on disposal of items.



Product made with recyclable materials.



Category III Products powered by safety voltage below 50V.



Ingress Production (see below).



Product that can be installed both indoors and outdoors.



Product that can be installed indoors.



Indicates the theoretical weight of the product, without wiring.



Product suitable for mounting on normally flammable surfaces.



It means that the "wine" Amber color avoid the "taste of light". Suggest and approved by the Comité Interprofessionnel du vin de Champagne (CIVIC) for the lighting of cellars, storage rooms and furnishings.



Product that can be inserted in furniture.



Indicates that the product can be walked on.



Indicates the type of optics (symmetrical or asymmetrical) and the degrees of aperture.



Size of hole to be drilled for mounting without formwork.



Indicates that the product can be dimmed.



Class I. Lighting system with earthing device.



Category II Lighting system with reinforced or double insulation, without earthing device.



Can be switched on by touching the metal surface.



Compliance with the RoHs Directive 2002/95/EC that bans the use of hazardous substances in electrical and electronic equipment (lead, mercury, etc.)

## INGRESS PROTECTION

### IP..

The 'resistance' offered by the device to penetration by solids and liquids is indicated by the prefix IP (international protection) followed by two significant numbers. The first number identifies the degree of protection against the ingress of solids. The second number identifies the degree of protection against the ingress of liquids.

**IP0.** Unprotected.

**IP1.** Protected against a solid object greater than 50 mm.

**IP2.** Protected against a solid object greater than 12 mm.

**IP3.** Protected against a solid object greater than 2.5 mm.

**IP4.** Protected against a solid object greater than 1 mm.

**IP5.** Protected against ingress of dust.

**IP6.** Completely protected against ingress of dust.

**IP0** Unprotected.

**IP1** Protected against vertical dripping water.

**IP2** Protected against vertical dripping water when tilted up 15°.

**IP3** Protected against rain.

**IP4** Protected against vertical splashing.

**IP5** Protected against jets of water.

**IP6** Protected against waves.

**IP7** Protected against effects from temporary immersion.



## MICROSPOT

DUST	16
DUST KIT	17
SKY	18
SKY KIT	19
ALGOL	20
HALLEY	21



# DUST

## L93.

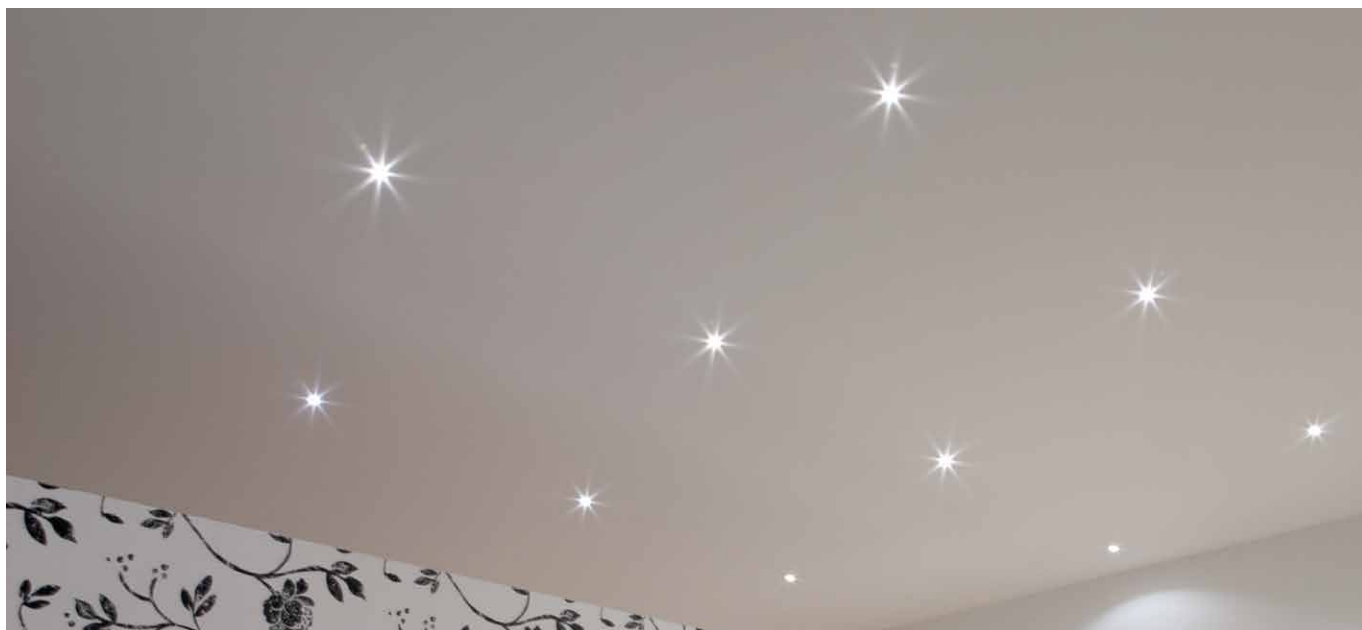

Flush-fitted in polished aluminium for decoration and courtesy lighting. Suitable for creating a 'starry sky' effect. Can be installed indoors and outdoors if partially protected, spring-mounted.

3mm high-brightness LED

Power: 0.1W@3.2Vdc

Lumen: 2Lm@3.2Vdc

Constant voltage supply 12Vdc only with GNTG box and in groups of three

Mandatory connection in multiples of three with CNTG box, cable 150 cm

Compulsory accessories for connection page 246

Constant voltage power supplies page 236

Dimming Accessories page 249



 **MADE IN ITALY**

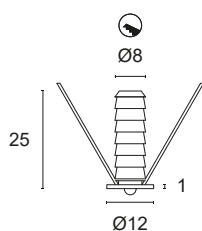

### BASIC CODES

**L93.**

### FINISHES

- 1** White
- 2** Matt black
- 6** Chrome

### LED COLOUR

- BF** 6000K
- BN** 4000K
- BC** 3000K
- BL** Blue
- VE** Green

### Code example:

DUST + White + 6000K = Code: L93.1BF

# DUST KIT

## KMQ.L93.

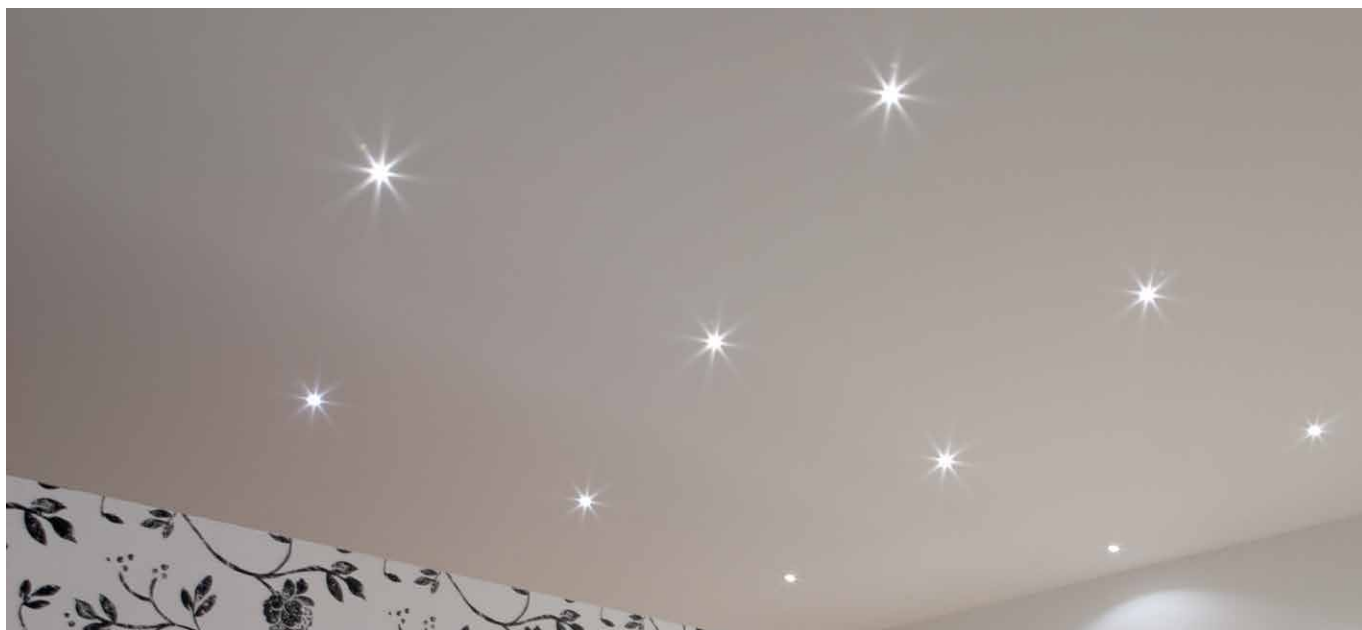

18-pack of the DUST model for decoration and courtesy lighting. Suitable for creating a 'starry sky' effect on an area of 1 square metre. The package includes the connection box and power supply. Can be installed indoors and outdoors if partially protected, spring-mounted.

3mm high-brightness LED

Power: 0.1W@3.2Vdc

Lumen: 2Lm@3.2Vdc

Constant 12Vdc voltage supply and CNTG/18 box

Mandatory connection in multiples of three with CNTG box, cable 150 cm

Dimming Accessories page 249

No. 18 DUST



No. 1 CNTG/18 BOX



No. 1 POWER SUPPLY

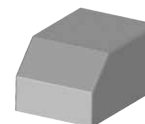

 **MADE IN ITALY**

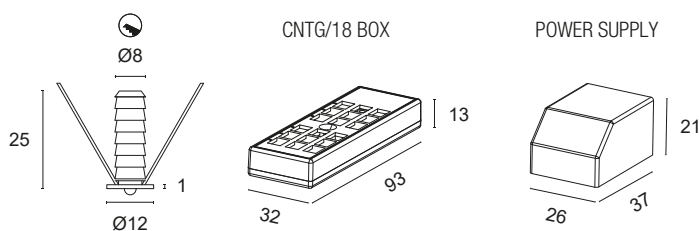

### BASIC CODES

**KMQ.L93.**

### FINISHES

- 1 White
- 2 Matt black
- 6 Chrome

### LED COLOUR

- BF** 6000K
- BN** 4000K
- BC** 3000K
- BL** Blue
- VE** Green

Code example:

DUST KIT + White + 6000K = Code: KMQ.L93.1BF

# SKY

## L90.



Flush-fitted in polished aluminium for decoration and courtesy lighting. Suitable for creating a 'starry sky' effect. Can be installed indoors and outdoors if partially protected, spring-mounted.

5mm high-brightness LED

Power: 0.1W@3.2Vdc

Lumen: 2Lm@3.2Vdc

Constant voltage supply 12Vdc only with GNTG box and in groups of three

Mandatory connection in multiples of three with CNTG box, cable 150 cm

Compulsory accessories for connection page 246

Constant voltage power supplies page 236

Dimming Accessories page 249



 **MADE IN ITALY**

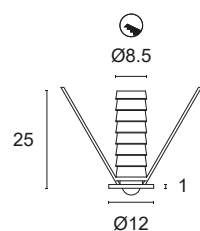

### BASIC CODES

**L90.**

### FINISHES

- 1** White
- 2** Matt black
- 6** Chrome

### LED COLOUR

- BF** 6000K
- BN** 4000K
- BC** 3000K
- BL** Blue

### Code example:

SKY + Chrome + 3000K = Code: L90.6BC

# SKY KIT

## KMQ.L90.



18-pack of the SKY model for decoration and courtesy lighting. Suitable for creating a 'starry sky' effect on an area of 1 square metre. The package includes the connection box and power supply. Can be installed indoors and outdoors if partially protected, spring-mounted.

5mm high-brightness LED

Power: 0.1W@3.2Vdc

Lumen: 2Lm@3.2Vdc

Constant 12Vdc voltage supply and CNTG/18 box

Mandatory connection in multiples of three with CNTG box, cable 150 cm

Dimming Accessories page 249

N°18 SKY



No. 1 CNTG/18 BOX



No. 1 POWER SUPPLY

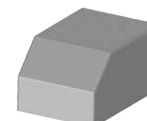

 **MADE IN ITALY**

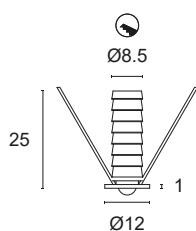

CNTG/18 BOX

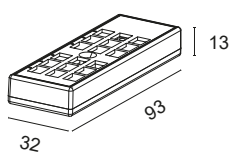

POWER SUPPLY

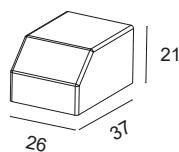

### BASIC CODES

**KMQ.L90.**

### FINISHES

- 1 White
- 2 Matt black
- 6 Chrome

### LED COLOUR

- BF** 6000K
- BN** 4000K
- BC** 3000K
- BL** Blue

Code example:

SKY KIT + Chrome + 3000K = Code: KMQ.L90.6BC



# ALGOL

## L80.



Flush-fitted in polished aluminium for decoration and courtesy lighting. Suitable for creating a 'starry sky' effect. Can be installed indoors and outdoors if partially protected, spring-mounted.

5mm high-brightness LED

Power: 0.5W@12Vdc

Lumen: 6Lm@12Vdc

Constant 12Vdc voltage supply

Parallel connection, 150 cm cable

Constant voltage power supplies page 236

Accessories for quick connection page 245

Dimming Accessories page 249



 **MADE IN ITALY**

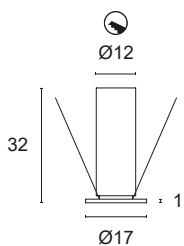

**BASIC CODES**

**L80.**

**FINISHES**

- 1** White
- 2** Matt black
- 6** Chrome

**LED COLOUR**

- BF** 6000K
- BN** 4000K
- BC** 3000K
- BL** Blue

**Code example:**

ALGOL + Chrome + Blue = Code: L80.6BL

# HALLEY

## L31.



Flush-fitted in polished aluminium for accent, decoration and courtesy lighting. Also indicated for 'starry sky'. Choice of secondary optics, can be installed indoors and outdoors if partially protected, spring-mounted.

Power LED CRI>80  
Power: 1W@350mA  
Lumen: 135Lm@350mA  
350mA constant current power supply  
Series connection, 50 cm cable

Constant current power supplies page 232  
Accessories for connection page 244  
Dimming Accessories page 249



 **MADE IN ITALY**

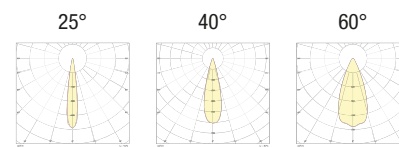
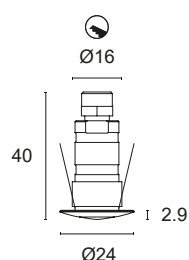

### BASIC CODES

**L31.**

### FINISHES

- 1 White
- 2 Matt black
- 6 Chrome
- 7 Brushed aluminium

### LIGHT BAND

- 25 25°
- 40 40°
- 60 60°

### LED COLOUR

- BN** 4000K
- BC** 3000K
- CC** 2700K
- BL** Blue
- VE** Green
- RO** Red
- AM** "Wine" Amber



Approved by  
CIVIC

### Code example:

HALLEY + White + Light Beam 40°+ 3000K = Code: L31.140BC



## INDOOR FLUSH FITTINGS

MINI VESTA	24
EOS	25
EOS Q	26
EOS CEILING LIGHT	27
EOS W	28
EOS W Q	29
EOS METAL	30
EOS METAL Q	31
IRIDE W	32
ZEFIRO W	33
VALLY	34
GIORDAN	35
GIORDAN CEILING LIGHT	36
TICHE	37
TICHE CEILING LIGHT	38
TICHE Q	39
TICHE Q CEILING LIGHT	40
TICHE MAXI	41
BASIK 1	42
BASIK Q	43
BIONIK 1	44
BIONIK Q	45
SIMPLE	46
SIMPLE Q	47
SIMPLE M	48
SIMPLE M Q	49
SIMPLE W	50
FOUR HOLE	51
FOUR HOLE Q	52
EGO METAL	53
EGO METAL Q	54
REMOVE PLUS	55
REMOVE MINUS	56
PAD	57
ERMA	58



# MINI VESTA

## L9X.

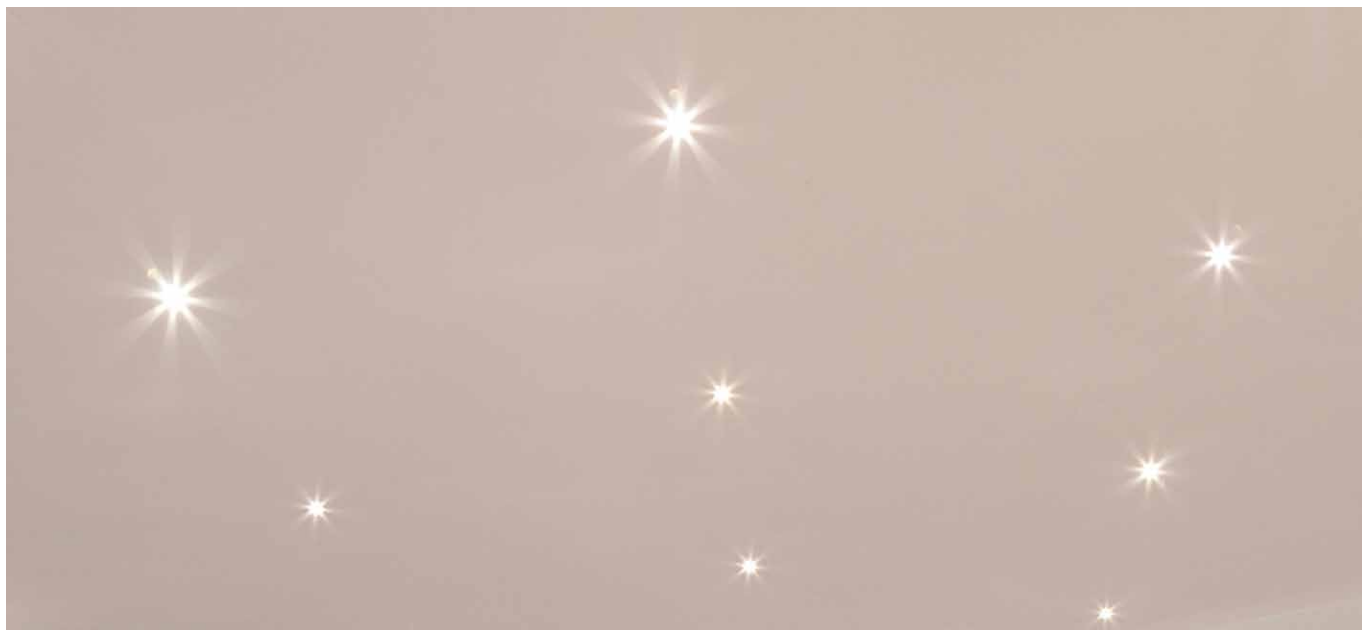

Flush-fitted in thermoplastic for accent, decoration and courtesy lighting. Diffuse lighting, can be installed indoors, pressure-mounted.

Power LED CRI>80

Power: 1W@350mA - 2W@500mA

Lumen: 135Lm@350mA - 216Lm@500mA

350mA - 500mA constant current power supply

Series connection, 50 cm cable

Constant current power supplies page 232-233

Accessories for quick connection page 244

Dimming Accessories page 249



 **MADE IN ITALY**

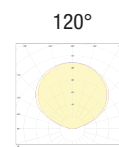
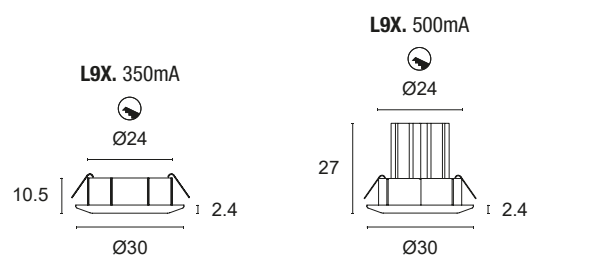

### BASIC CODES

**L9X.**

### FINISHES

- 1 White
- 6 Chrome
- 7 Brushed aluminium
- 8 Transparent

### LIGHT BAND

- 00 120°

### LED COLOUR

- BN 4000K
- BC 3000K
- CC 2700K
- BL Blue
- VE Green
- RO Red
- AM "Wine" Amber

### POWER

- 3 1x1W - 350mA - 135 lm**
- 5 1x2W - 500mA - 216 lm**



Approved by  
CIVIC

Code example:

MINI VESTA + White + 120° light beam + 3000K + 1W = Code: L9X.100BC3

# EOS

## L95.



Flush-fitted in thermoplastic for accent, decoration and courtesy lighting. Choice of secondary optics, can be installed indoors, press-fit.

Power LED CRI>80

Power: 1W@350mA - 2W@500mA

Lumen: 135Lm@350mA - 216Lm@500mA

350mA - 500mA constant current power supply

Series connection, 50 cm cable

Constant current power supplies page 232-233

Accessories for quick connection page 244

Dimming Accessories page 249

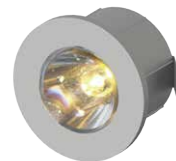

 **MADE IN ITALY**

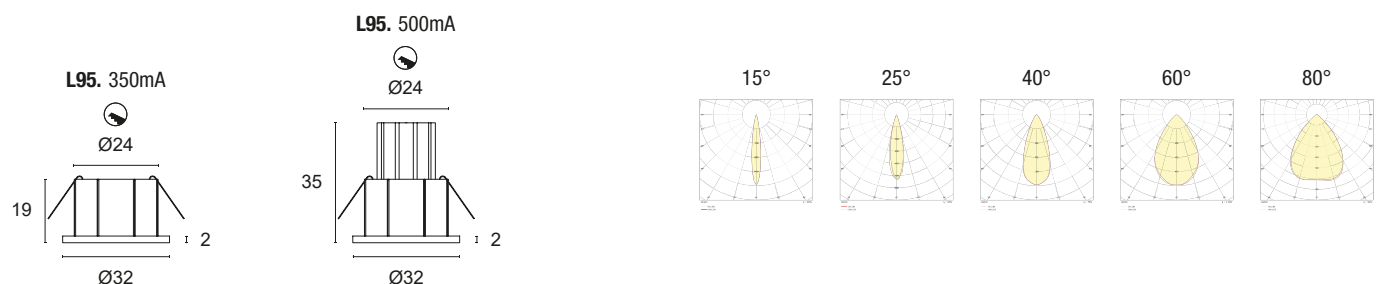

### BASIC CODES

**L95.**

### FINISHES

- 1 White
- 2 Matt black
- 3 Brushed gold
- 6 Chrome
- 7 Brushed aluminium
- 8 Transparent
- 9 Polished gold

### LIGHT BAND

- 15 15°
- 25 25°
- 40 40°
- 60 60°
- 80 80°

### LED COLOUR

- BN 4000K
- BC 3000K
- CC 2700K
- BL Blue
- VE Green
- RO Red
- AM "Wine" Amber

### POWER

- 3 1x1W - 350mA - 135 lm**
- 5 1x2W - 500mA - 216 lm**



Code example:

EOS + Brushed Aluminium + 15° light beam + 3000K + 1W = Code: L95.715BC3

# EOS Q

## L9Q.



Flush-fitted in thermoplastic for accent, decoration and courtesy lighting. Choice of secondary optics, can be installed indoors, press-fit.

Power LED CRI>80

Power: 1W@350mA - 2W@500mA

Lumen: 135Lm@350mA - 216Lm@500mA

350mA - 500mA constant current power supply

Series connection, 50 cm cable

Constant current power supplies page 232-233

Accessories for quick connection page 244

Dimming Accessories page 249

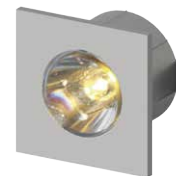

 **MADE IN ITALY**

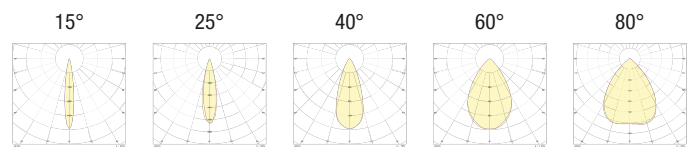
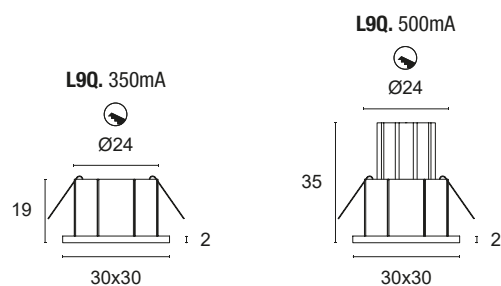

### BASIC CODES

**L9Q.**

### FINISHES

- 1 White
- 2 Matt black
- 3 Brushed gold
- 6 Chrome
- 7 Brushed aluminium
- 8 Transparent
- 9 Polished gold

### LIGHT BAND

- 15 15°
- 25 25°
- 40 40°
- 60 60°
- 80 80°

### LED COLOUR

- BN 4000K
- BC 3000K
- CC 2700K
- BL Blue
- VE Green
- RO Red
- AM "Wine" Amber

### POWER

- 3 1x1W - 350mA - 135 lm**
- 5 1x2W - 500mA - 216 lm**



Code example:

EOS Q + Brushed Aluminium + 15° light beam + 3000K + 1W = Code: L9Q.715BC3

# EOS CEILING LIGHT

## L95D.



Thermoplastic ceiling light for accent, decoration and courtesy lighting. Choice of secondary optics, can be installed indoors, mounting with concealed screws.

Power LED CRI>80

Power: 1W@350mA

Lumen: 135Lm@350mA

350mA constant current power supply

Series connection, 50 cm cable

Constant current power supplies page 232

Accessories for quick connection page 244

Dimming Accessories page 249

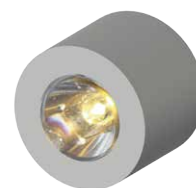

 **MADE IN ITALY**

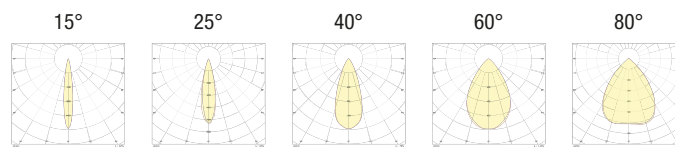
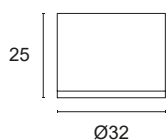

### BASIC CODES

## L95D.

### FINISHES

- 1 White
- 2 Matt black
- 3 Brushed gold
- 6 Chrome
- 7 Brushed aluminium
- 8 Transparent
- 9 Polished gold

### LIGHT BAND

- 15 15°
- 25 25°
- 40 40°
- 60 60°
- 80 80°

### LED COLOUR

- BN** 4000K
- BC** 3000K
- CC** 2700K
- BL** Blue
- VE** Green
- RO** Red
- AM** "Wine" Amber



Code example:

EOS CEILING LIGHT + Brushed Aluminium + 25° light beam + 3000K + 1W = Code: L95D.725RO



# EOS W

## L9512.



Flush-fitted in thermoplastic for accent, decoration and courtesy lighting. Diffuse lighting, can be installed indoors, pressure-mounted.

WICOP LED CRI>80  
Power: 2W@12Vdc  
Lumen: 216Lm@12Vdc  
Constant 12Vdc voltage supply  
Parallel connection, 50 cm cable

Constant voltage power supplies page 236  
Accessories for quick connection page 245  
Dimming Accessories page 249



 **MADE IN ITALY**

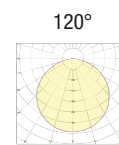
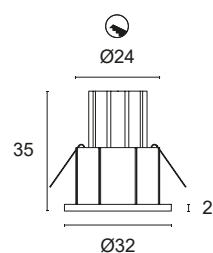

### BASIC CODES

**L9512.**

### FINISHES

- 1 White
- 2 Matt black
- 3 Brushed gold
- 6 Chrome
- 7 Brushed aluminium
- 8 Transparent
- 9 Polished gold

### LED COLOUR

- BN** 4000K
- BC** 3000K
- CC** 2700K

### Code example:

EOS W + White + 3000K = Code: L9512.1BC

# EOS W Q

## L9Q12.



Flush-fitted in thermoplastic for accent, decoration and courtesy lighting. Diffuse lighting, can be installed indoors, pressure-mounted.

WICOP LED CRI>80  
 Power: 2W@12Vdc  
 Lumen: 216Lm@12Vdc  
 Constant 12Vdc voltage supply  
 Parallel connection, 50 cm cable

Constant voltage power supplies page 236  
 Accessories for quick connection page 245  
 Dimming Accessories page 249

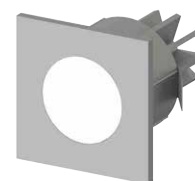

**MADE IN ITALY**

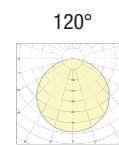
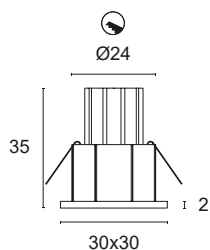

### BASIC CODES

**L9Q12.**

### FINISHES

- 1 White
- 2 Matt black
- 3 Brushed gold
- 6 Chrome
- 7 Brushed aluminium
- 8 Transparent
- 9 Polished gold

### LED COLOUR

- BN** 4000K
- BC** 3000K
- CC** 2700K

### Code example:

EOS W Q + White + 3000K = Code: L9Q12.1BC

# EOS METAL

## L95M.



Flush-fitted in polished aluminium with power LED for accent, decoration and courtesy lighting. Choice of secondary optics, can be installed indoors. Flush-mounted with springs.

Power LED CRI>80

Power: 2W@500mA

Lumen: 216Lm@500mA

500mA constant current power supply

Series connection, 50 cm cable

Constant current power supplies page 233

Dimming Accessories page 249

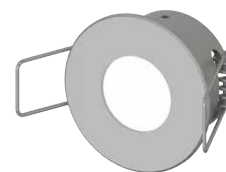

**MADE IN ITALY**

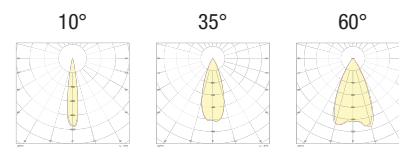
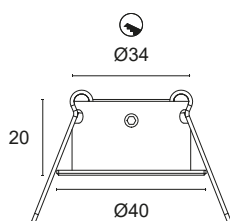

### BASIC CODES

**L95M.**

### FINISHES

- 1 White
- 2 Matt black
- 5 Gloss aluminium
- 7 Brushed aluminium

### LIGHT BAND

- 10 10°
- 35 35°
- 60 60°

### LED COLOUR

- BN 4000K
- BC 3000K
- CC 2700K
- BL Blue
- VE Green
- RO Red
- AM "Wine" Amber



Approved by  
CIVIC

### Code example:

EOS METAL + Brushed Aluminium + 40° light beam + 3000K = Code: L95M.740BC

# EOS METAL Q

## L9QM.



Flush-fitted in polished aluminium with power LED for accent, decoration and courtesy lighting. Choice of secondary optics, can be installed indoors. Flush-mounted with springs.

Power LED CRI>80  
Power: 2W@500mA  
Lumen: 216Lm@500mA  
500mA constant current power supply  
Series connection, 50 cm cable

Constant current power supplies page 233  
Dimming Accessories page 249

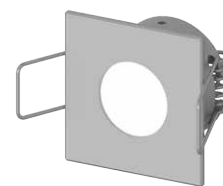

 **MADE IN ITALY**

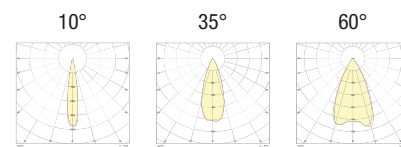
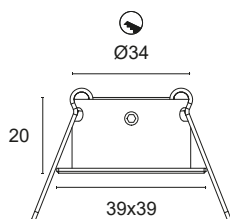

### BASIC CODES

**L95QM.**

### FINISHES

- 1 White
- 2 Matt black
- 5 Gloss aluminium
- 7 Brushed aluminium

### LIGHT BAND

- 10 10°
- 35 35°
- 60 60°

### LED COLOUR

- BN** 4000K
- BC** 3000K
- CC** 2700K
- BL** Blue
- VE** Green
- RO** Red
- AM** "Wine" Amber



Approved by  
CIVIC

### Code example:

EOS METAL Q + Brushed Aluminium + 40° light beam + 3000K = Code: L9QM.740BC



# IRIDE W

L9912.



Flush-fitted in thermoplastic for accent, decoration and courtesy lighting. Diffuse lighting, can be installed indoors, pressure-mounted.

WICOP LED CRI>80  
Power: 2W@12Vdc  
Lumen: 216Lm@12Vdc  
Constant 12Vdc voltage supply  
Parallel connection, 50 cm cable

Constant voltage power supplies page 236  
Accessories for quick connection page 245  
Dimming Accessories page 249

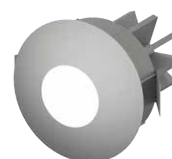

 **MADE IN ITALY**

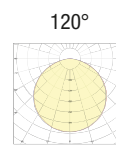
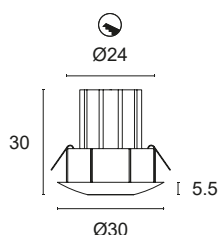

## BASIC CODES

**L9912.**

## FINISHES

- 1 White
- 2 Matt black
- 3 Brushed gold
- 6 Chrome
- 7 Brushed aluminium
- 8 Transparent
- 9 Polished gold

## LED COLOUR

- BN** 4000K
- BC** 3000K
- CC** 2700K

## Code example:

IRIDE W + White + 3000K = Code: L9912.1BC

# ZEFIRO W

## L9812.



Flush-fitted in thermoplastic for accent, decoration and courtesy lighting. Diffuse lighting, can be installed indoors, pressure-mounted.

WICOP LED CRI>80  
Power: 2W@12Vdc  
Lumen: 216Lm@12Vdc  
Constant 12Vdc voltage supply  
Parallel connection, 50 cm cable

Constant voltage power supplies page 236  
Accessories for quick connection page 245  
Dimming Accessories page 249

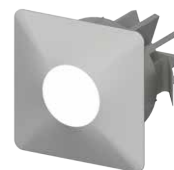

 **MADE IN ITALY**

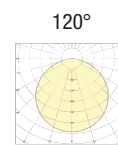
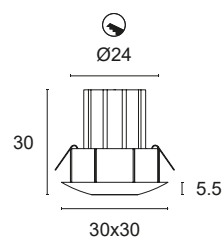

### BASIC CODES

**L9812.**

### FINISHES

- 1 White
- 2 Matt black
- 3 Brushed gold
- 6 Chrome
- 7 Brushed aluminium
- 8 Transparent
- 9 Polished gold

### LED COLOUR

- BN** 4000K
- BC** 3000K
- CC** 2700K

### Code example:

ZEFIRO W + White + 3000K = Code: L9812.1BC

# VALLY

## F02LD.



Printed metal light for primary lighting in small rooms, accessories or furniture. Even, diffuse lighting, can be installed indoors. Mounting with pressure springs.

MID POWER LED CRI>80

Power: 3W@12Vdc

Lumen: 324Lm@12Vdc

Constant 12Vdc voltage supply

Parallel connection, 50 cm cable

Constant voltage power supplies page 236

Accessories for quick connection page 245

Dimming Accessories page 249



 **MADE IN ITALY**

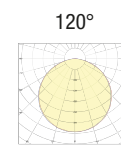
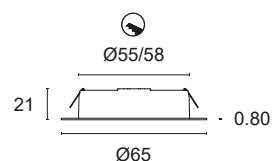

### BASIC CODES

**F02LD.**

### FINISHES

- 1 White
- 2 Matt black
- 4 Bronze
- 6 Chrome
- 7 Brushed aluminium
- 9 Polished gold

### GLASS

- 0 Opaline

### LED COLOUR

- BN** 4000K
- BC** 3000K
- CC** 2700K

### Code example:

VALLY + Brushed Aluminium + Opal Glass + 4000K = Code: F02LD.70BN

# GIORDAN

## F01LD.

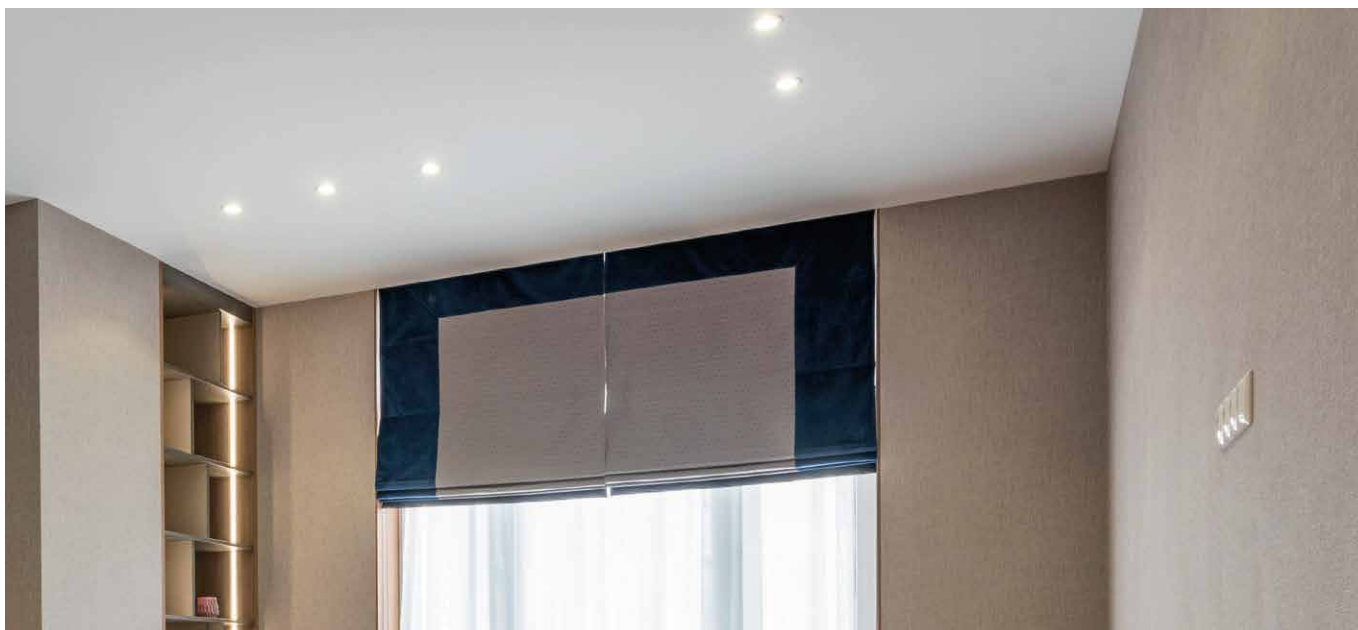

Thermoplastic recessed light system for primary lighting in small rooms, accessories or furniture. Even, diffuse lighting, can be installed indoors. Mounting with pressure springs.

MID POWER LED CRI>80

Power: 3W@12Vdc

Lumen: 324Lm@12Vdc

Constant 12Vdc voltage supply

Parallel connection, 50 cm cable

Constant voltage power supplies page 236

Accessories for quick connection page 245

Dimming Accessories page 249

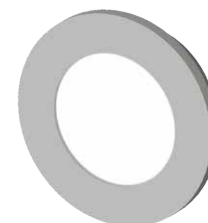

 **MADE IN ITALY**

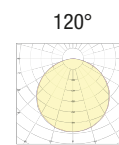
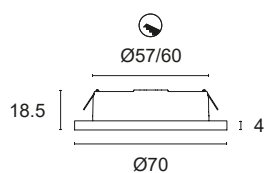

### BASIC CODES

**F01LD.**

### FINISHES

- 1 White
- 2 Matt black
- 4 Bronze
- 6 Chrome
- 7 Brushed aluminium
- 9 Polished gold

### GLASS

- 0 Opaline

### LED COLOUR

- BN** 4000K
- BC** 3000K
- CC** 2700K

### Code example:

GIORDAN + Brushed Aluminium + Opal Glass + 3000K = Code: F01LD.70BC



# GIORDAN CEILING LIGHT

F01LDD.



Thermoplastic ceiling light for primary lighting in small rooms, accessories or furniture. Even, diffuse lighting, can be installed indoors. Mounting with concealed screws.

MID POWER LED CRI>80

Power: 3W@12Vdc

Lumen: 324Lm@12Vdc

Constant 12Vdc voltage supply

Parallel connection, 50 cm cable

Constant voltage power supplies page 236

Accessories for quick connection page 245

Dimming Accessories page 249



 **MADE IN ITALY**

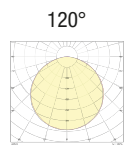
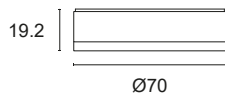

## BASIC CODES

**F01LDD.**

## FINISHES

- 1 White
- 2 Matt black
- 4 Bronze
- 6 Chrome
- 7 Brushed aluminium
- 9 Polished gold

## GLASS

- 0 Opaline

## LED COLOUR

- BN** 4000K
- BC** 3000K
- CC** 2700K

Code example:

GIORDAN CEILING LIGHT + Brushed Aluminium + Opal Glass + 3000K = Code: F01LDD.70BC

# TICHE

## L15.



Polished aluminium light for primary lighting in small rooms, accessories or furniture. Even, diffuse lighting, can be installed indoors. Mounting with pressure springs even on small surfaces.

MID POWER LED CRI>80

Power: 3W@12Vdc

Lumen: 459Lm@12Vdc

Constant 12Vdc voltage supply

Parallel connection, 50 cm cable

Constant voltage power supplies page 236

Accessories for quick connection page 245

Dimming Accessories page 249

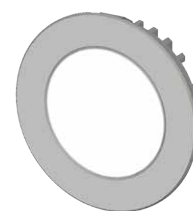

 **MADE IN ITALY**

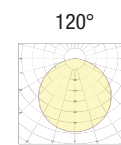
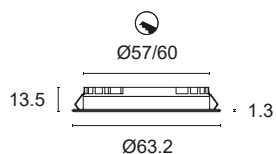

### BASIC CODES

**L15.**

### FINISHES

- 1 White
- 2 Matt black
- 3 Brushed gold
- 4 Bronze
- 5 Gloss aluminium
- 6 Chrome
- 7 Brushed aluminium
- 9 Polished gold

### LED COLOUR

- BN** 4000K
- BC** 3000K
- CC** 2700K

Code example:

TICHE + Brushed aluminium + 3000K = Code: L15.7BC

# TICHE CEILING LIGHT

## L15D.



Polished aluminium ceiling light for primary lighting in small rooms, accessories or furniture. Even, diffuse lighting, can be installed indoors. Mounting with concealed screws.

MID POWER LED CRI>80

Power: 3W@12Vdc

Lumen: 459Lm@12Vdc

Constant 12Vdc voltage supply

Parallel connection, 50 cm cable

Constant voltage power supplies page 236

Accessories for quick connection page 245

Dimming Accessories page 249



 **MADE IN ITALY**

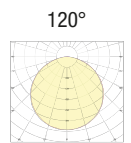
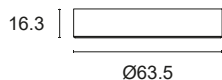

### BASIC CODES

**L15D.**

### FINISHES

- 1 White
- 2 Matt black
- 5 Gloss aluminium
- 7 Brushed aluminium

### LED COLOUR

- BN** 4000K
- BC** 3000K
- CC** 2700K

### Code example:

TICHE CEILING LIGHT + White + 3000K = Code: L15D.1BC

# TICHE Q

## L15Q.

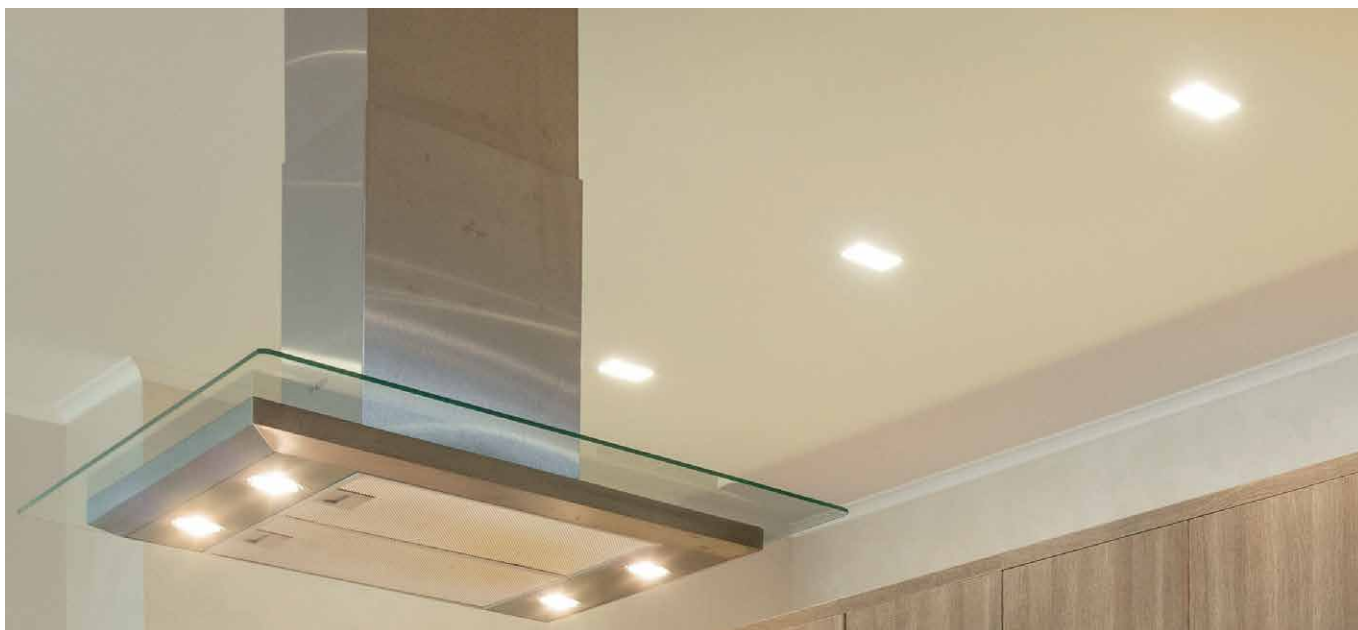

Polished aluminium light for primary lighting in small rooms, accessories or furniture. Even, diffuse lighting, can be installed indoors. Mounting with pressure springs even on small surfaces.

MID POWER LED CRI>80

Power: 3W@12Vdc

Lumen: 459Lm@12Vdc

Constant 12Vdc voltage supply

Parallel connection, 50 cm cable

Constant voltage power supplies page 236

Accessories for quick connection page 245

Dimming Accessories page 249



 **MADE IN ITALY**

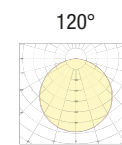
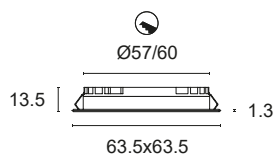

### BASIC CODES

**L15Q.**

### FINISHES

- 1 White
- 2 Matt black
- 3 Brushed gold
- 4 Bronze
- 5 Gloss aluminium
- 6 Chrome
- 7 Brushed aluminium
- 9 Polished gold

### LED COLOUR

- BN** 4000K
- BC** 3000K
- CC** 2700K

### Code example:

TICHE Q + Brushed aluminium + 3000K = Code: L15Q.7BC



# TICHE Q CEILING LIGHT

## L15QD.



Polished aluminium ceiling light for primary lighting in small rooms, accessories or furniture. Even, diffuse lighting, can be installed indoors. Mounting with concealed screws.

MID POWER LED CRI>80

Power: 3W@12Vdc

Lumen: 459Lm@12Vdc

Constant 12Vdc voltage supply

Parallel connection, 50 cm cable

Constant voltage power supplies page 236

Accessories for quick connection page 245

Dimming Accessories page 249

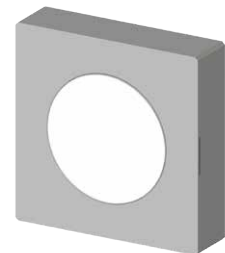

 **MADE IN ITALY**

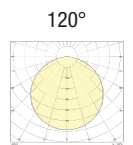
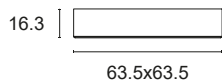

### BASIC CODES

**L15QD.**

### FINISHES

- 1 White
- 2 Matt black
- 5 Gloss aluminium
- 7 Brushed aluminium

### LED COLOUR

- BN** 4000K
- BC** 3000K
- CC** 2700K

### Code example:

TICHE Q CEILING LIGHT + White + 3000K = Code: L15QD.1BC

# TICHE MAXI

## L15M.

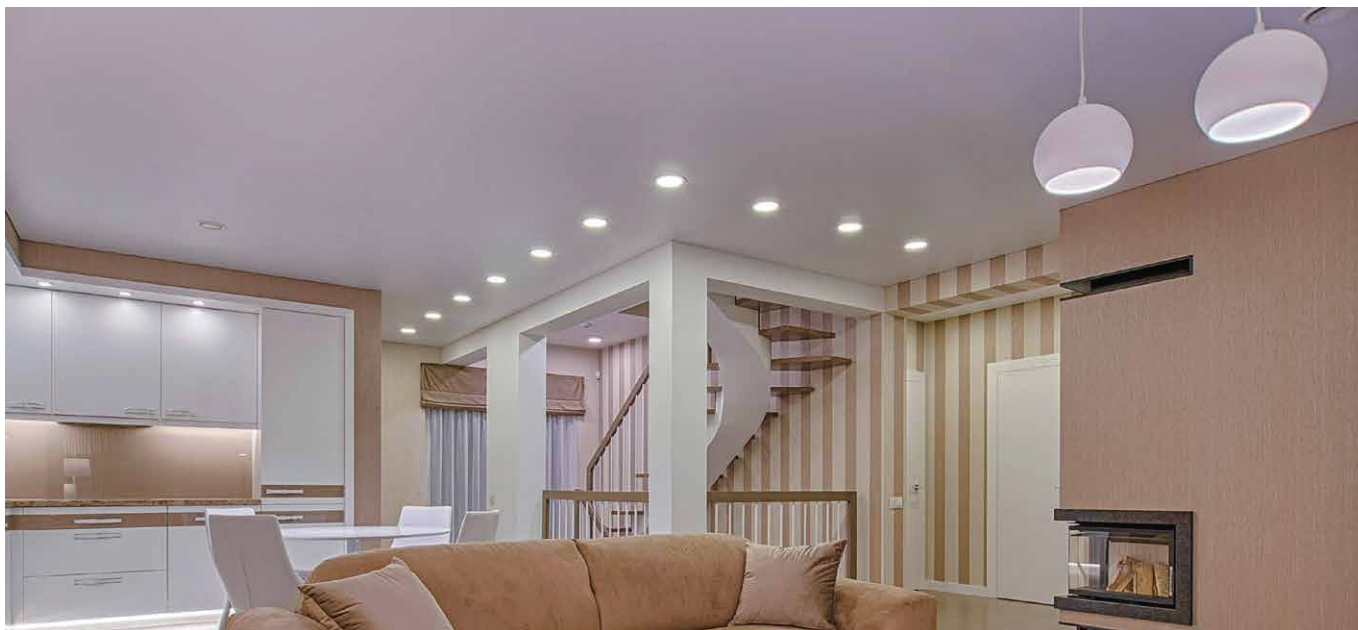

Polished aluminium recessed light for primary lighting in small rooms, accessories or furniture. Even, diffuse lighting, can be installed indoors. Flush mounting on plasterboard with pressure springs.

MID POWER LED CRI>80

Power: 9W@12Vdc

Lumen: 945Lm@12Vdc

Constant 12Vdc voltage supply

Parallel connection, 50 cm cable

Constant voltage power supplies page 236

Accessories for quick connection page 245

Dimming Accessories page 249

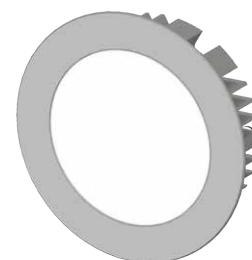

 **MADE IN ITALY**

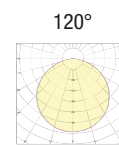
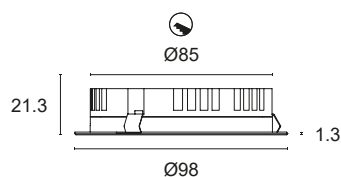

### BASIC CODES

**L15M.**

### FINISHES

- 1 White
- 2 Matt black
- 5 Gloss aluminium
- 7 Brushed aluminium

### LED COLOUR

- BN** 4000K
- BC** 3000K
- CC** 2700K

### Code example:

TICHE MAXI + Brushed aluminium + 3000K = Code: L15M.7BC

# BASIK 1

L01.



Polished, decorated aluminium recessed light with powerful LEDs suitable for decorative lighting of residential and retail environments. Choice of secondary optics. Can be flush fitted indoors and outdoors if partially protected. Flush-mounted with springs.

Power LED CRI>80

Power: 3W@350mA - 6W@500mA

Lumen: 405Lm@350mA - 648Lm@500mA

350mA - 500mA constant current power supply

Series connection, 50 cm cable

Constant current power supplies page 232-233

Dimming Accessories page 249



 **MADE IN ITALY**

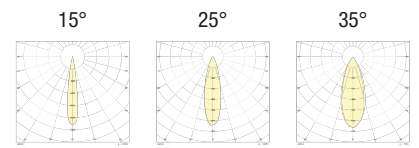
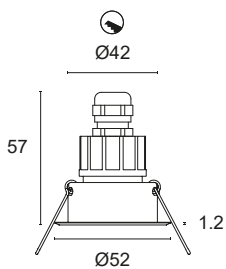

## BASIC CODES

**L01.**

## FINISHES

- 1 White
- 2 Matt black
- 5 Gloss aluminium
- 6 Chrome
- 7 Brushed aluminium

## LIGHT BEAM

- 15 15°
- 25 25°
- 35 35°

## LED COLOUR

- BN 4000K
- BC 3000K
- CC 2700K
- BL Blue
- VE Green
- RO Red
- AM "Wine" Amber

## POWER

- 3 3x1W - 350mA - 405 lm**
- 5 3x2W - 500mA - 648 lm**



Code example:

BASIK 1 + Brushed Aluminium + 15° light beam + 3000K + 3W = Code: L01.715BC3

# BASIK Q

## L02.



Polished, decorated aluminium recessed square light with powerful LEDs suitable for decorative lighting of residential and retail environments. Choice of secondary optics. Can be flush fitted indoors and outdoors if partially protected. Flush-mounted with springs.

Power LED CRI>80

Power: 3W@350mA - 6W@500mA

Lumen: 405Lm@350mA - 648Lm@500mA

350mA - 500mA constant current power supply

Series connection, 50 cm cable

Constant current power supplies page 232-233

Dimming Accessories page 249

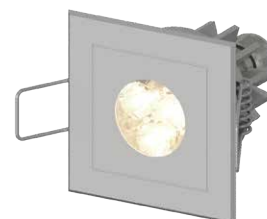

**MADE IN ITALY**

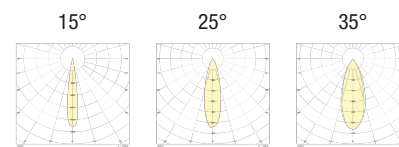
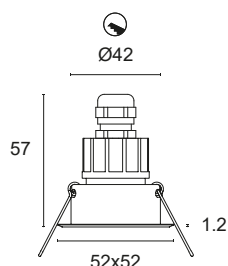

### BASIC CODES

**L02.**

### FINISHES

- 1 White
- 2 Matt black
- 5 Gloss aluminium
- 6 Chrome
- 7 Brushed aluminium

### LIGHT BEAM

- 15 15°
- 25 25°
- 35 35°

### LED COLOUR

- BN 4000K
- BC 3000K
- CC 2700K
- BL Blue
- VE Green
- RO Red
- AM "Wine" Amber

### POWER

- 3 3x1W - 350mA - 405 lm**
- 5 3x2W - 500mA - 648 lm**



Code example:

BASIK Q + Brushed Aluminium + 15° light beam + 3000K + 3W = Code: L02.715BC3

# BIONIK 1

## L21.



Polished, decorated aluminium recessed light with powerful LEDs suitable for decorative lighting of residential and retail environments. Choice of secondary recessed optics. Can be flush fitted indoors and outdoors if partially protected. Flush-mounted with springs.

Power LED CRI>80

Power: 3W@350mA - 6W@500mA

Lumen: 405Lm@350mA - 648Lm@500mA

350mA - 500mA constant current power supply

Series connection, 50 cm cable

Constant current power supplies page 232-233

Dimming Accessories page 249



 **MADE IN ITALY**

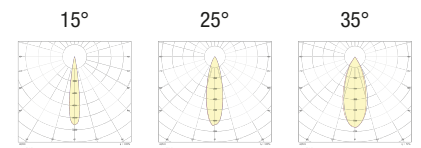
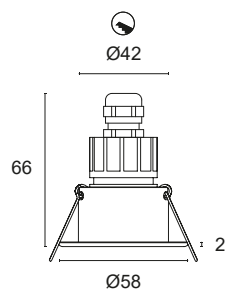

### BASIC CODES

**L21.**

### FINISHES

- 1 White
- 2 Matt black
- 5 Gloss aluminium
- 6 Chrome
- 7 Brushed aluminium

### LIGHT BEAM

- 15 15°
- 25 25°
- 35 35°

### LED COLOUR

- BN 4000K
- BC 3000K
- CC 2700K
- BL Blue
- VE Green
- RO Red
- AM "Wine" Amber

### POWER

- 3 3x1W - 350mA - 405 lm**
- 5 3x2W - 500mA - 648 lm**



Approved by  
CIVIC

Code example:

BIONIK 1 + Brushed Aluminium + 15° light beam + 3000K + 3W = Code: L21.715BC3



# BIONIK Q

## L22.



Polished, decorated aluminium recessed square light with powerful LEDs suitable for decorative lighting of residential and retail environments. Choice of secondary recessed optics. Can be flush fitted indoors and outdoors if partially protected. Flush-mounted with springs.

Power LED CRI>80

Power: 3W@350mA - 6W@500mA

Lumen: 405Lm@350mA - 648Lm@500mA

350mA - 500mA constant current power supply

Series connection, 50 cm cable

Constant current power supplies page 232-233

Dimming Accessories page 249



 **MADE IN ITALY**

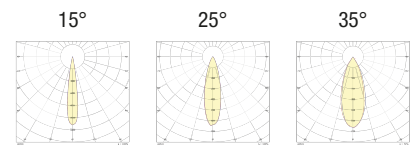
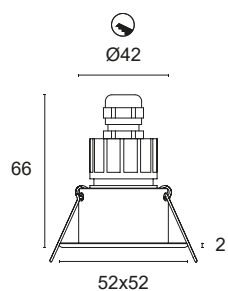

### BASIC CODES

**L22.**

### FINISHES

- 1 White
- 2 Matt black
- 5 Gloss aluminium
- 6 Chrome
- 7 Brushed aluminium

### LIGHT BEAM

- 15 15°
- 25 25°
- 35 35°

### LED COLOUR

- BN 4000K
- BC 3000K
- CC 2700K
- BL Blue
- VE Green
- RO Red
- AM "Wine" Amber

### POWER

- 3 3x1W - 350mA - 405 lm**
- 5 3x2W - 500mA - 648 lm**



Code example:

BIONIK Q + Brushed Aluminium + 15° light beam + 3000K + 3W = Code: L22.715BC3

# SIMPLE

## L10.



Polished aluminium recessed light with COB LEDs CRI>90 for primary lighting in residential and retail environments. Choice of secondary optics. Excellent lumen/watt ratio; can be installed flush on plasterboard indoors, spring-mounted.

COB LED CRI>90

Power: 7W@200mA

Lumen: 916Lm@200mA

200mA constant current power supply

Series connection, 50 cm cable

Constant current power supplies page 234

Dimming Accessories page 249



 **MADE IN ITALY**

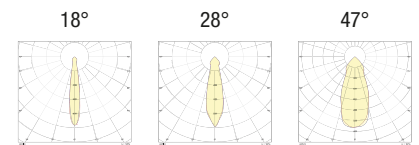
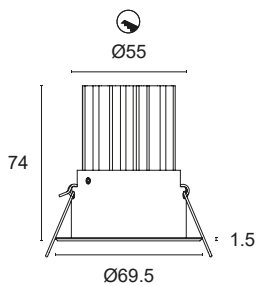

### BASIC CODES

**L10.**

### FINISHES

- 1 White
- 2 Matt black
- 5 Gloss aluminium
- 6 Chrome
- 7 Brushed aluminium

### LIGHT BEAM

- 18 18°
- 28 28°
- 47 47°

### LED COLOUR

- BN 4000K
- BC 3000K
- CC 2700K

Code example:

SIMPLE + White + Light Beam 18° + 4000K + 2W = Code: L10.118BN

# SIMPLE Q

## L10Q.



Polished aluminium recessed square light with COB LEDs CRI>90 for primary lighting in residential and retail environments. Choice of secondary optics. Excellent lumen/watt ratio; can be installed flush on plasterboard indoors, spring-mounted.

COB LED CRI>90

Power: 7W@200mA

Lumen: 916Lm@200mA

200mA constant current power supply

Series connection, 50 cm cable

Constant current power supplies page 234

Dimming Accessories page 249



 **MADE IN ITALY**

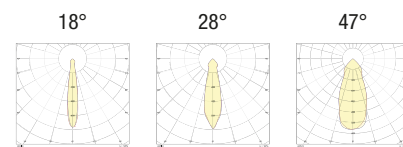
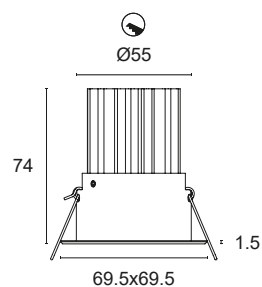

### BASIC CODES

## L10Q.

### FINISHES

- 1 White
- 2 Matt black
- 5 Gloss aluminium
- 6 Chrome
- 7 Brushed aluminium

### LIGHT BEAM

- 18 18°
- 28 28°
- 47 47°

### LED COLOUR

- BN 4000K
- BC 3000K
- CC 2700K

### Code example:

SIMPLE Q + White + Light Beam 18° + 4000K + 2W = Code: L10Q.118BN

# SIMPLE M

## L11.



Polished aluminium recessed light with COB LEDs CRI>90 for primary lighting in large residential and retail environments. Protected choice of secondary optics. Excellent lumen/watt ratio; can be installed flush on plasterboard indoors. Spring mounted.

COB LED CRI>90

Power: 7W@200mA

Lumen: 916Lm@200mA

200mA constant current power supply

Series connection, 50 cm cable

Constant current power supplies page 234

Dimming Accessories page 249



 **MADE IN ITALY**

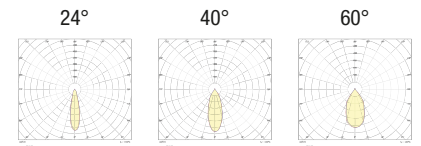
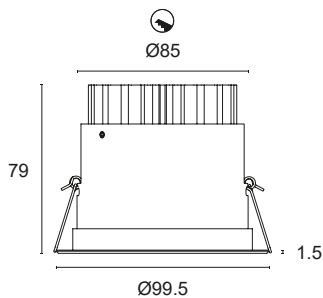

**BASIC CODES**

**L11.**

**FINISHES**

- 1 White
- 2 Matt black
- 5 Gloss aluminium
- 6 Chrome
- 7 Brushed aluminium

**LIGHT BEAM**

- 24 24°
- 40 40°
- 60 60°

**LED COLOUR**

- BN 4000K
- BC 3000K
- CC 2700K

**Code example:**

SIMPLE M + White + Light Beam 24° + 4000K = Code: L11.124BN

# SIMPLE M Q

## L11Q.



Polished aluminium recessed light with COB LEDs CRI>90 for primary lighting in large residential and retail environments. Protected choice of secondary optics. Excellent lumen/watt ratio; can be installed flush on plasterboard indoors. Spring mounted.

COB LED CRI>90

Power: 7W@200mA

Lumen: 916Lm@200mA

200mA constant current power supply

Series connection, 50 cm cable

Constant current power supplies page 234

Dimming Accessories page 249



 **MADE IN ITALY**

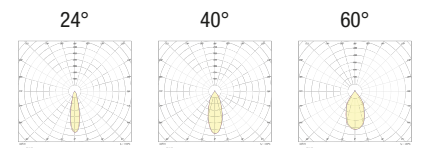
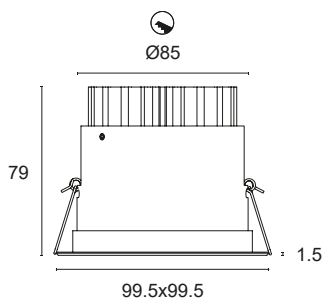

**BASIC CODES**

**L11Q.**

**FINISHES**

- 1 White
- 2 Matt black
- 5 Gloss aluminium
- 6 Chrome
- 7 Brushed aluminium

**LIGHT BEAM**

- 24 24°
- 40 40°
- 60 60°

**LED COLOUR**

- BN 4000K
- BC 3000K
- CC 2700K

**Code example:**

SIMPLE M Q + White + Light Beam 24° + 4000K = Code: L11Q.124BN



# SIMPLE W

## L12.



Polished aluminium recessed light with COB LEDs CRI>90 for primary lighting in large residential and retail environments. Protected choice of secondary optics. Excellent lumen/watt ratio; can be installed flush on plasterboard indoors. Spring mounted.

COB LED CRI>90

Power: 16W@450mA

Lumen: 1895Lm@450mA

450mA constant current power supply

Series connection, 50 cm cable

Constant current power supplies page 234

Dimming Accessories page 249



 **MADE IN ITALY**

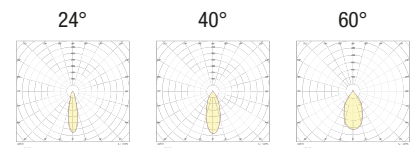
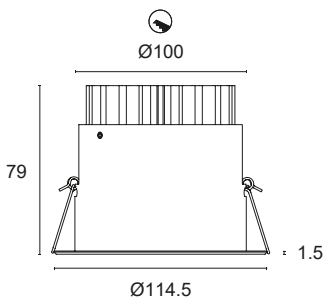

**BASIC CODES**

**L12.**

**FINISHES**

- 1 White
- 2 Matt black
- 5 Gloss aluminium
- 6 Chrome
- 7 Brushed aluminium

**LIGHT BEAM**

- 24 24°
- 40 40°
- 60 60°

**LED COLOUR**

- BN 4000K
- BC 3000K
- CC 2700K

**Code example:**

SIMPLE W + White + Light Beam 24° + 4000K = Code: L12.124BN

# FOUR HOLE L24.



Polished, decorated aluminium recessed light with powerful LEDs suitable for decorative lighting of residential and retail environments. Choice of secondary recessed optics. Can be flush fitted indoors. Flush-mounted with springs.

Power LED CRI>80

Power: 4W@350mA – 8W@500mA

Lumen: 540Lm@350mA – 864Lm@500mA

350mA - 500mA constant current power supply

Series connection, 50 cm cable

Constant current power supplies page 232-233

Dimming Accessories page 249

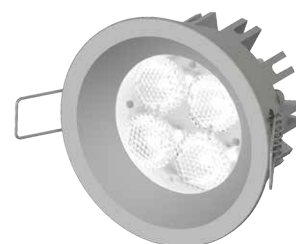

 **MADE IN ITALY**

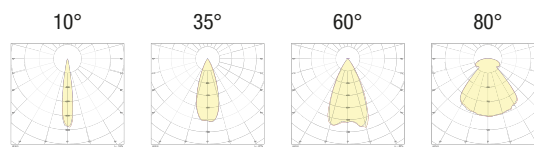
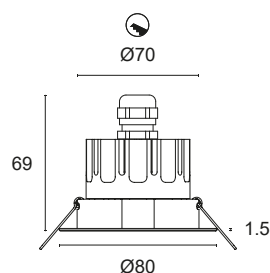

## BASIC CODES

**L24.**

## FINISHES

- 1 White
- 2 Matt black
- 5 Gloss aluminium
- 7 Brushed aluminium

## LIGHT BEAM

- 10 10°
- 35 35°
- 60 60°
- 80 80°

## LED COLOUR

- BN 4000K
- BC 3000K
- CC 2700K
- BL Blue
- VE Green
- RO Red
- AM "Wine" Amber

## POWER

- 3 4x1W - 350mA - 540 lm**
- 5 4x2W - 500mA - 864 lm**



Approved by  
CIVIC

Code example:

FOUR HOLE + White + 80° light beam + 3000K + 4W = Code: L24.180BC3

# FOUR HOLE Q

## L25.



Polished, decorated aluminium recessed square light with powerful LEDs suitable for decorative lighting of residential and retail environments. Choice of secondary recessed optics. Can be flush fitted indoors. Flush-mounted with springs.

Power LED CRI>80

Power: 4W@350mA – 8W@500mA

Lumen: 540Lm@350mA – 864Lm@500mA

350mA - 500mA constant current power supply

Series connection, 50 cm cable

Constant current power supplies page 232-233

Dimming Accessories page 249

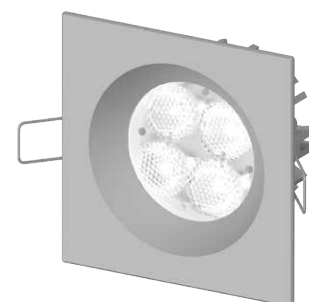

 **MADE IN ITALY**

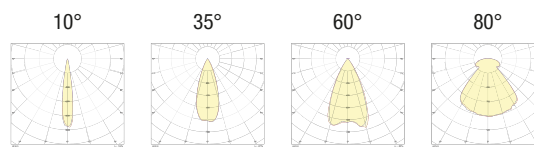
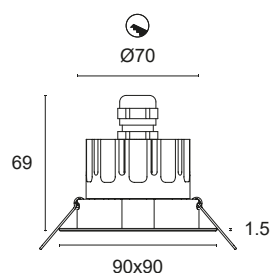

### BASIC CODES

**L25.**

### FINISHES

- 1 White
- 2 Matt black
- 5 Gloss aluminium
- 7 Brushed aluminium

### LIGHT BEAM

- 10 10°
- 35 35°
- 60 60°
- 80 80°

### LED COLOUR

- BN 4000K
- BC 3000K
- CC 2700K
- BL Blue
- VE Green
- RO Red
- AM "Wine" Amber

### POWER

- 3 4x1W - 350mA - 540 lm**
- 5 4x2W - 500mA - 864 lm**



Code example:

FOUR HOLE Q + White + 80° light beam + 3000K + 4W = Code: L25.180BC3

# EGO METAL

## L04.

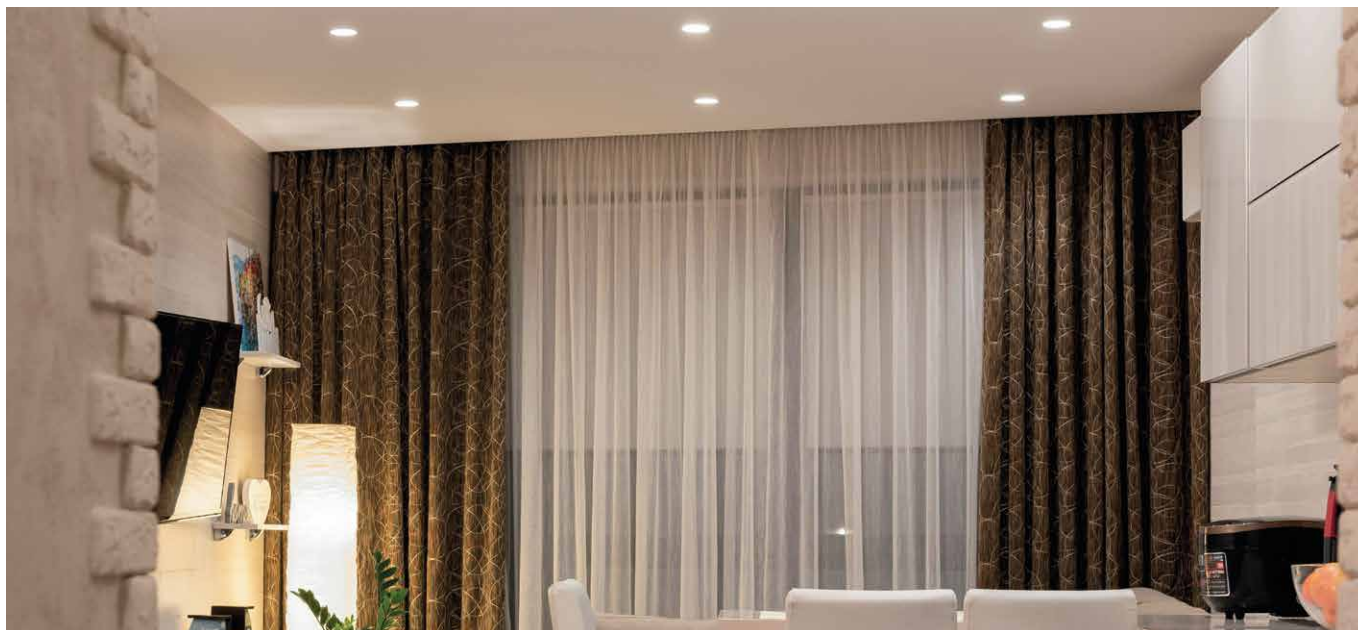

Directional metal recessed light with COB LEDs CRI>90 for primary lighting in residential and retail environments. Choice of secondary optics. Can be flush fitted indoors, spring-mounted

COB LED CRI>90

Power: 7W@200mA

Lumen: 916Lm@200mA

200mA constant current power supply

Series connection, 50 cm cable

Constant current power supplies page 234

Dimming Accessories page 249



 **MADE IN ITALY**

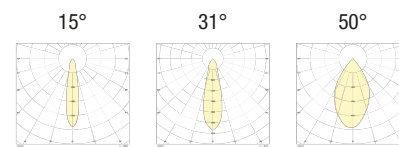
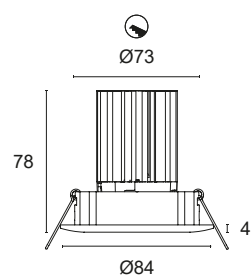

### BASIC CODES

**L04.**

### FINISHES

- 1 White
- 2 Matt black
- 6 Chrome
- 7 Brushed aluminium
- 9 Polished gold

### LIGHT BEAM

- 15 15°
- 31 31°
- 50 50°

### LED COLOUR

- BN 4000K
- BC 3000K
- CC 2700K

### Code example:

EGO METAL + Brushed Aluminium + 15° light beam + 2700K = Code: L04.715CC

# EGO METAL Q

L05.



Directional square recessed light with COB LEDs CRI>90 for primary lighting in residential and retail environments. Choice of secondary optics. Can be flush fitted indoors, spring-mounted

COB LED CRI>90

Power: 7W@200mA

Lumen: 916Lm@200mA

200mA constant current power supply

Series connection, 50 cm cable

Constant current power supplies page 234

Dimming Accessories page 249

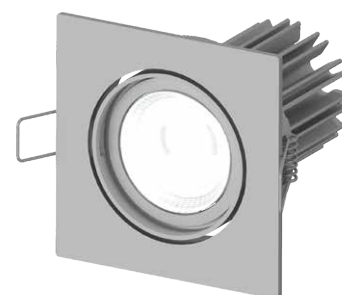

 **MADE IN ITALY**

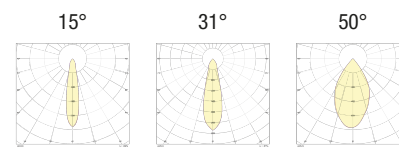
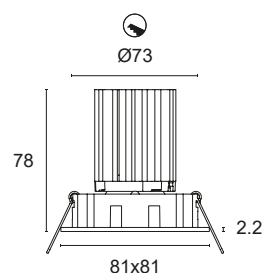

**BASIC CODES**

**L05.**

**FINISHES**

- 1 White
- 2 Matt black
- 6 Chrome
- 7 Brushed aluminium
- 9 Polished gold

**LIGHT BEAM**

- 15 15°
- 31 31°
- 50 50°

**LED COLOUR**

- BN 4000K
- BC 3000K
- CC 2700K

Code example:

EGO METAL Q + Brushed Aluminium + 15° light beam + 2700K = Code: L05.715CC



# REMOVE PLUS

## L15P.



Flush-fitted in polished aluminium for accent, decoration and courtesy or emergency lighting. Even, diffuse lighting, can be installed indoors or outdoors. Mounting on plasterboard or brickwork with formwork.

SMD LED CRI>85

Power: 0.7W@24Vdc

Lumen: 100Lm@24Vdc

Constant voltage supply 24Vdc

Parallel connection, 50 cm cable

Constant voltage power supplies page 237

Installation accessories page 272

Dimming Accessories page 249



 **MADE IN ITALY**

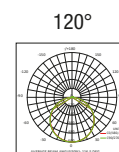
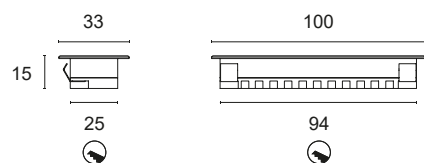

### BASIC CODES

**L15P.**

### FINISHES

- 1 White
- 2 Matt black
- 5 Gloss aluminium
- 7 Brushed aluminium

### LED COLOUR

- BN** 4000K
- BC** 3000K
- CC** 2700K

### Code example:

REMOVE PLUS + Brushed aluminium + 3000K = Code: L15P.7BC

# REMOVE MINUS

## L15S.



Flush-fitted in polished aluminium for accent, decoration and courtesy or emergency lighting. Diffuse lighting, can be installed indoors, on plasterboard or brick with formwork.

SMD LED CRI>90

Power: 1.8W@24Vdc

Lumen: 135Lm@24Vdc

Constant 24Vdc voltage supply

Parallel connection, 50 cm cable

Constant voltage power supplies page 237

Installation accessories page 272

Dimming Accessories page 249



 **MADE IN ITALY**

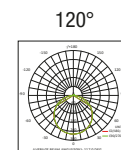
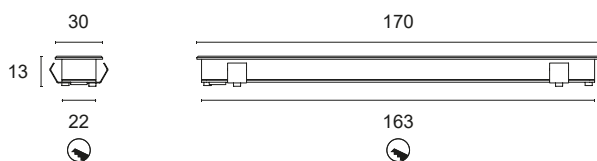

### BASIC CODES

**L15S.**

### FINISHES

- 1 White
- 2 Matt black
- 5 Gloss aluminium
- 7 Brushed aluminium

### LED COLOUR

- BN** 4000K
- BC** 3000K
- CC** 2700K

Code example:

REMOVE MINUS + Brushed aluminium + 3000K = Code: L15S.7BC

# PAD L13Q.



Polished aluminium recessed light for primary lighting in small rooms and accessories. Also suitable as a step marker or emergency light. Even, diffuse lighting, can be installed indoors.  
Mounting with pressure springs or with formwork for plasterboard or masonry.

MID POWER LED CRI>80

Power: 3W@12Vdc

Lumen: 459Lm@12Vdc

Constant 12Vdc voltage supply

Parallel connection, 50 cm cable

Constant voltage power supplies page 236

Installation accessories page 271

Dimming Accessories page 249

 **MADE IN ITALY**

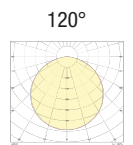
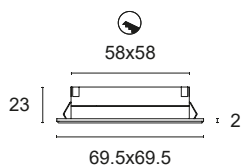
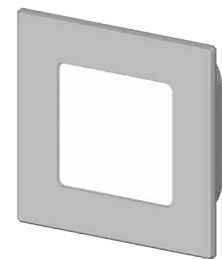

## BASIC CODES

**L13Q.**

## FINISHES

- 1 White
- 2 Matt black
- 5 Gloss aluminium
- 7 Brushed aluminium

## LED COLOUR

- BN** 4000K
- BC** 3000K
- CC** 2700K

## Code example:

PAD + White + 3000K = Code: L13Q.1BC

# ERMA

## L13.

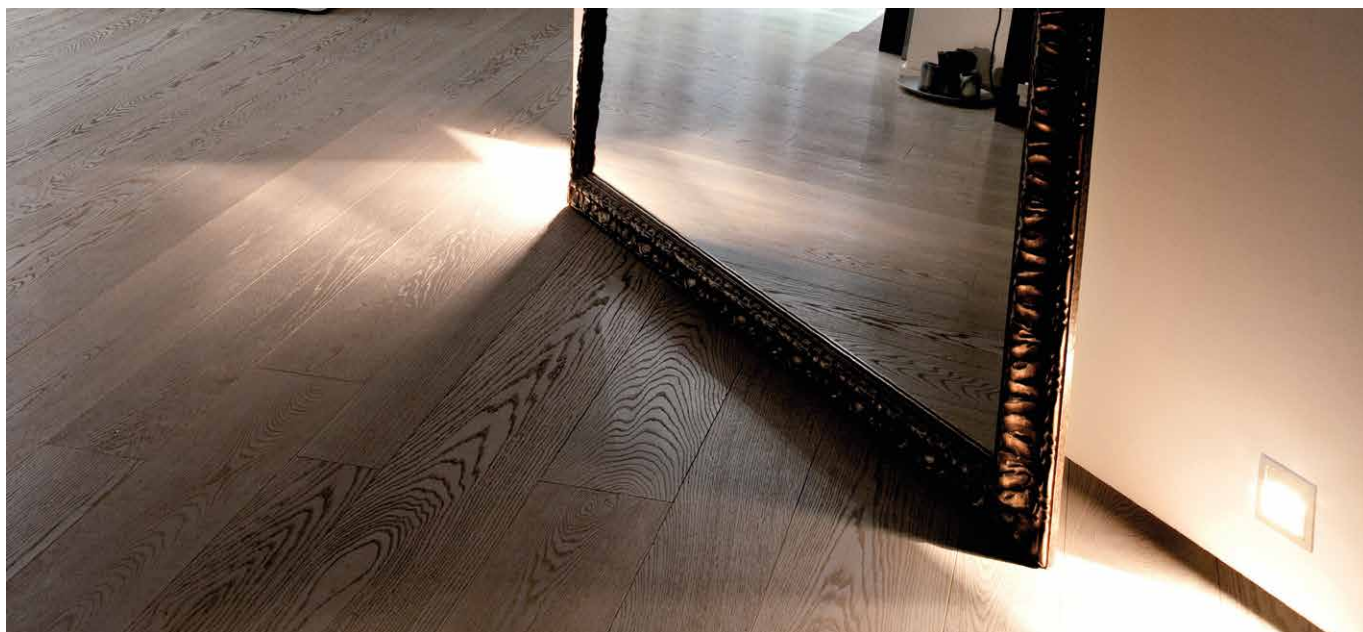

Flush-fitted in thermoplastic for accent and courtesy lighting. Also suitable as a step marker or emergency light. Even, diffuse lighting, can be installed indoors on plasterboard or brick with standard 503 formwork (not included).

MID POWER LED CRI>80

Power: 1.5W@12Vdc

Lumen: 100Lm@12Vdc

Mains power supply included

Parallel connection, 20 cm cable

Constant voltage power supplies page 236

Dimming Accessories page 249

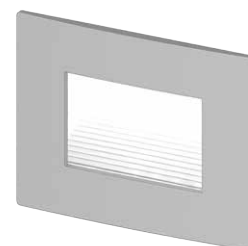

 **MADE IN ITALY**

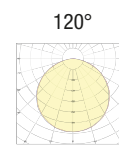
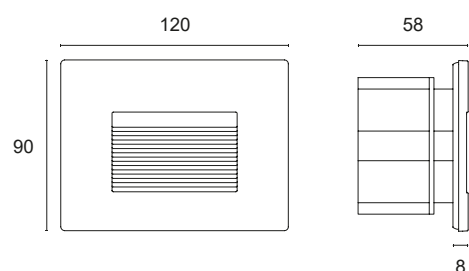

### BASIC CODES

**L13.**

### FINISHES

- 1** White
- 2** Matt black
- 7** Brushed aluminium

### LED COLOUR

- BN** 4000K
- BC** 3000K

Code example:

ERMA + White + 4000K = Code: L13.1BN











## INDOOR AND OUTDOOR RECESSED LIGHTS

REMOVE PLUS WP	62
HOLLY	63
HALISSA	64
MEMO	65
DEHO 2	66
DEHO 3	67
DEHO 4	68
DEHO 5	69
DEHO Q	70
DARDO 2	71
DARDO 3	72
DARDO Q	73
ACSO 1	74
ACSO 2	75
ACSO 3	76
ACRUX 1	77

# REMOVE PLUS WP

## L15P.WP



Flush-fitted in polished aluminium for accent, decoration and courtesy or emergency lighting. Even, diffuse lighting, can be installed indoors or outdoors. Mounting on plasterboard or brickwork with formwork.

SMD LED CRI>85

Power: 0.7W@24Vdc

Lumen: 100Lm@24Vdc

Constant voltage supply 24Vdc

Parallel connection, 50 cm cable

Constant voltage power supplies page 237

Installation accessories page 272

Dimming Accessories page 249



 **MADE IN ITALY**

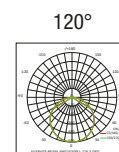
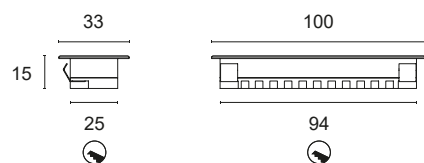

### BASIC CODES

**L15P.WP**

### FINISHES

- 1 White
- 2 Matt black
- 5 Gloss aluminium
- 7 Brushed aluminium

### LED COLOUR

- BN** 4000K
- BC** 3000K
- CC** 2700K

Code example:

REMOVE PLUS WP + Brushed aluminium + 3000K = Code: L15P.WP7BC

# HOLLY

## L30R.



Flush-fitted in polished 304 stainless steel with power LED for accent, decoration, courtesy or step marker lighting. Choice of secondary optics. Can be fitted in the floor, wall or in plasterboard indoors and outdoors. Mounting with formwork.

Power LED CRI>80  
Power: 1W@350mA  
Lumen: 135Lm@350mA  
350mA constant current power supply  
Series connection, 50 cm cable

Constant current power supplies page 232  
Installation accessories page 270  
Dimming Accessories page 249

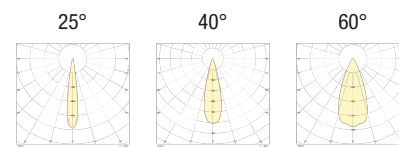
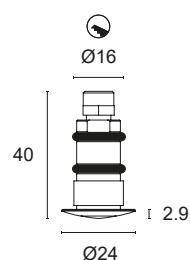

 **MADE IN ITALY**





### BASIC CODES

**L30R.**







### LIGHT BEAM

-  **25** 25°
-  **40** 40°
-  **60** 60°

### GLASS

-  **T** Transparent
-  **S** Brushed

### LED COLOUR

-  **BN** 4000K
-  **BC** 3000K
-  **CC** 2700K
-  **BL** Blue
-  **VE** Green
-  **RO** Red
-  **AM** "Wine" Amber



Approved by  
CIVIC

Code example:

HOLLY + Light beam 25° + Transparent glass + 3000K = Code: L30R.25TBC

# HALISSA

## L30Q.

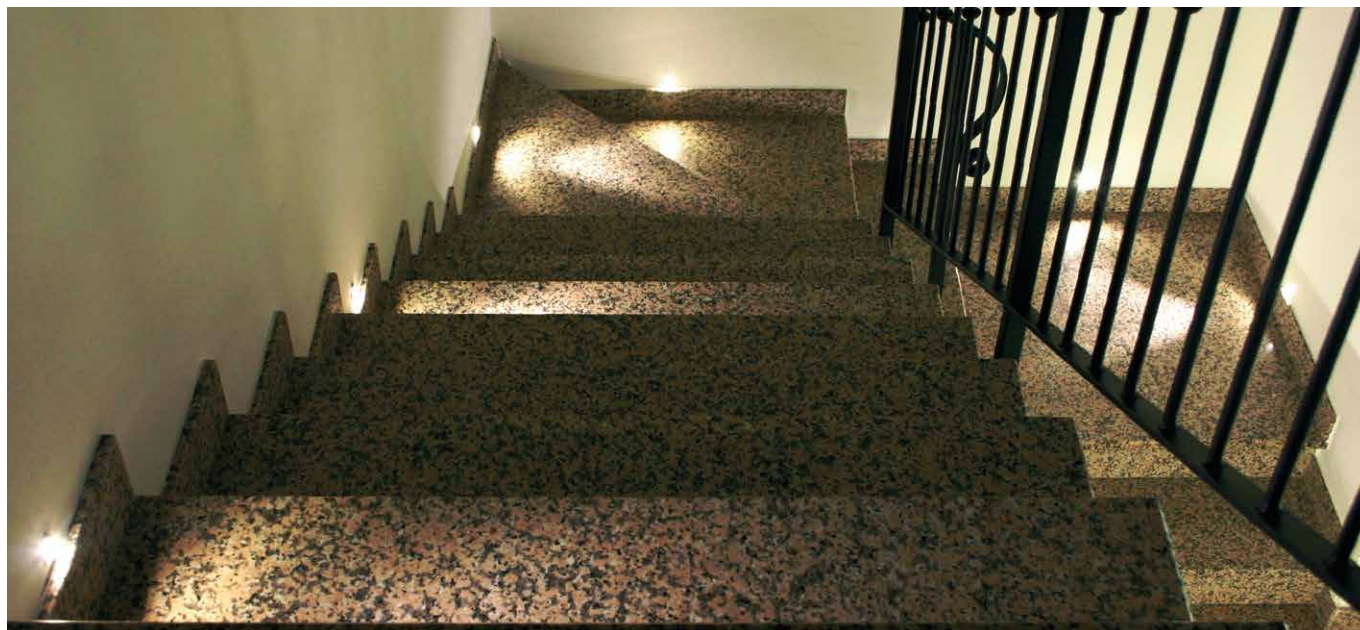

Flush-fitted in polished 304 stainless steel with power LED for accent, decoration, courtesy or step marker lighting. Choice of secondary optics. Can be fitted in the floor, wall or in plasterboard indoors and outdoors. Mounting with formwork.

Power LED CRI>80  
Power: 1W@350mA  
Lumen: 135Lm@350mA  
350mA constant current power supply  
Series connection, 50 cm cable

Constant current power supplies page 232  
Installation accessories page 270  
Dimming Accessories page 249

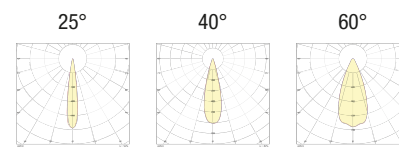
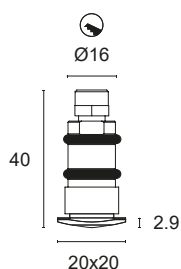

 **MADE IN ITALY**





### BASIC CODES

**L30Q.**







### LIGHT BEAM

-  **25** 25°
-  **40** 40°
-  **60** 60°

### GLASS

-  **T** Transparent
-  **S** Brushed

### LED COLOUR

-  **BN** 4000K
-  **BC** 3000K
-  **CC** 2700K
-  **BL** Blue
-  **VE** Green
-  **RO** Red
-  **AM** "Wine" Amber



Approved by  
CIVIC

Code example:

HALISSA + Light beam 25°+ Transparent glass + 3000K = Code: L30Q.25TBC



# MEMO

## L30S.



Flush-fitted in polished 304 stainless steel with power LED for decoration, courtesy or step marker lighting. Diffuse lighting with anti-glare cowling. Can be fitted in the wall or floor, indoors and outdoors. Mounting with formwork.

Power LED CRI>80

Power: 1W@350mA

Lumen: 135Lm@350mA

350mA constant current power supply

Series connection, 50 cm cable

Constant current power supplies page 232

Installation accessories page 270

Dimming Accessories page 249

 **MADE IN ITALY**

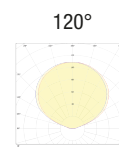
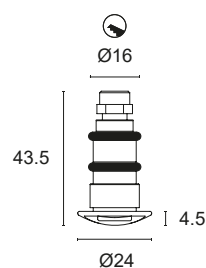

### BASIC CODES







**L30S.**

### LIGHT BEAM

 **R1** Radial 1 aperture  **T** Transparent

### GLASS

### LED COLOUR

 **BN** 4000K  
 **BC** 3000K  
 **CC** 2700K  
 **BL** Blue  
 **VE** Green  
 **RO** Red  
 **AM** "Wine" Amber



### Code example:

MEMO + Radial light beam 1 aperture + Clear glass + 3000K = Code: L30S.R1TBC

# DEHO 2

## L402.



Flush-fitted in polished 304 stainless steel with power LED for accent, decoration, courtesy or step marker lighting. Choice of secondary optics. Can be fitted in the floor, wall or in plasterboard indoors and outdoors. Mounting with formwork or ring with springs.

Power LED CRI>80  
Power: 1W@350mA - 2W@500mA  
Lumen: 135Lm@350mA - 216Lm@500mA  
350mA - 500mA constant current power supply  
Series connection, 50 cm cable

Constant current power supplies page 232-233  
Installation accessories page 271  
Dimming Accessories page 249





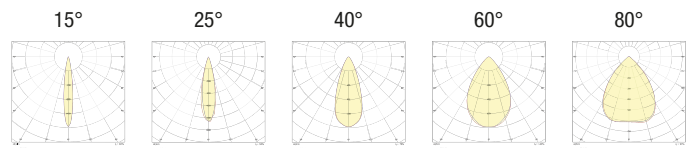
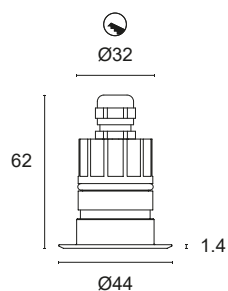

 **MADE IN ITALY**





### BASIC CODES

**L402.**







### LIGHT BEAM

-  **15** 15°
-  **25** 25°
-  **40** 40°
-  **60** 60°
-  **80** 80°

### GLASS

-  **T** Transparent
-  **S** Brushed

### LED COLOUR

-  **BN** 4000K
-  **BC** 3000K
-  **CC** 2700K
-  **BL** Blue
-  **VE** Green
-  **RO** Red
-  **AM** "Wine" Amber

### POWER

- 3 1x1W - 350mA - 135 lm**
- 5 1x2W - 500mA - 216 lm**



Code example:  
DEHO 2 + Light Beam 25° + Clear Glass + 3000k +1W = Code: L402.25TBC3

# DEHO 3

L403.



Flush-fitted in polished 304 stainless steel for accent, decoration, courtesy or step marker lighting. Anti-glare radial diffuser, can be installed indoors and outdoors. Mounting with formwork for brickwork.

Power LED CRI>80

Power: 1W@350mA - 2W@500mA

Lumen: 135Lm@350mA - 216Lm@500mA

350mA - 500mA constant current power supply

Series connection, 50 cm cable

Constant voltage power supplies p. 232 - 233

Installation accessories page 271

Dimming Accessories page 249



 **MADE IN ITALY**

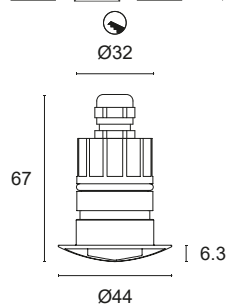







BASIC CODES

**L403.**

LIGHT BEAM

 **R1** Radial 1 aperture

LED COLOUR

-  **BN** 4000K
-  **BC** 3000K
-  **CC** 2700K
-  **BL** Blue
-  **VE** Green
-  **RO** Red
-  **AM** "Wine" Amber



POWER

**3 1x1W - 350mA - 135 lm**  
**5 1x2W - 500mA - 216 lm**

Code example:

DEHO 3 + radial light beam 1 aperture + 3000K + 1W = Code: L403.R1BC3



# DEHO 4

## L404.

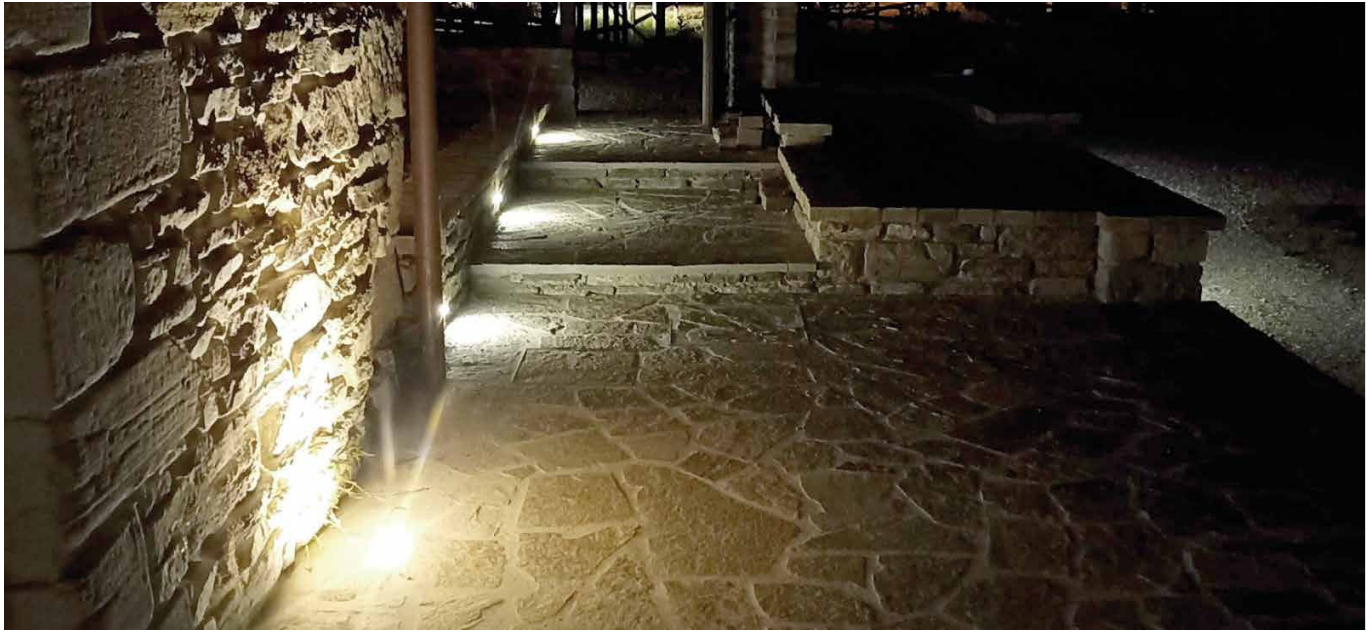

Flush-fitted in polished 304 stainless steel for accent, decoration, courtesy or step marker lighting. Anti-glare radial diffuser, can be installed indoors and outdoors. Mounting with formwork for brickwork.

Power LED CRI>80

Power: 1W@350mA - 2W@500mA

Lumen: 135Lm@350mA - 216Lm@500mA

350mA - 500mA constant current power supply

Series connection, 50 cm cable

Constant voltage power supplies p. 232 - 233

Installation accessories page 271

Dimming Accessories page 249



 **MADE IN ITALY**

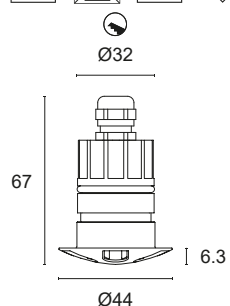







BASIC CODES

**L404.**

LIGHT BEAM

 **R5** Radial 5 apertures

LED COLOUR

-  **BN** 4000K
-  **BC** 3000K
-  **CC** 2700K
-  **BL** Blue
-  **VE** Green
-  **RO** Red
-  **AM** "Wine" Amber



POWER

**3 1x1W - 350mA - 135 lm**

**5 1x2W - 500mA - 216 lm**

Code example:

DEHO 4 + radial light beam 5 apertures + 3000K + 1W = Code: L404.R5BC3

# DEHO 5

## L402B



Flush-fitted in polished 304 stainless steel for decoration, courtesy and step marker lighting. Opal diffuser. Can be fitted in the floor or on the wall indoors and outdoors, mounting with formwork.

Power LED CRI>80

Power: 1W@350mA - 2W@500mA

Lumen: 135Lm@350mA - 216Lm@500mA

350mA - 500mA constant current power supply

Series connection, 50 cm cable

Constant voltage power supplies p. 232 - 233

Installation accessories page 271

Dimming Accessories page 249



 **MADE IN ITALY**

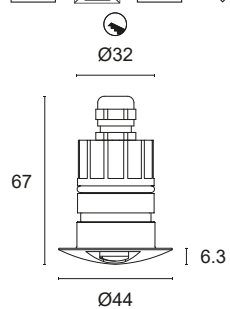
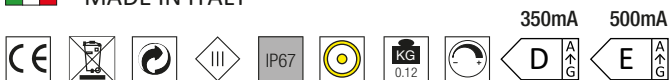







**BASIC CODES**

**L402B.**

**LIGHT BEAM**

 **R2** Radial 2 apertures

**LED COLOUR**

-  **BN** 4000K
-  **BC** 3000K
-  **CC** 2700K
-  **BL** Blue
-  **VE** Green
-  **RO** Red
-  **AM** "Wine" Amber



**POWER**

**3 1x1W - 350mA - 135 lm**  
**5 1x2W - 500mA - 216 lm**

**Code example:**

DEHO 5 + radial light beam 2 apertures + 3000K + 1W = Code: L402B.R2BC3



# DEHO Q

## L405.



Flush-fitted in polished 304 stainless steel with power LED for accent, decoration, courtesy or step marker lighting. Choice of secondary optics. Can be fitted in the floor, wall or in plasterboard indoors and outdoors. Mounting with formwork or ring with springs.

Power LED CRI>80  
Power: 1W@350mA - 2W@500mA  
Lumen: 135Lm@350mA - 216Lm@500mA  
350mA - 500mA constant current power supply  
Series connection, 50 cm cable

Constant voltage power supplies p. 232 - 233  
Installation accessories page 271  
Dimming Accessories page 249





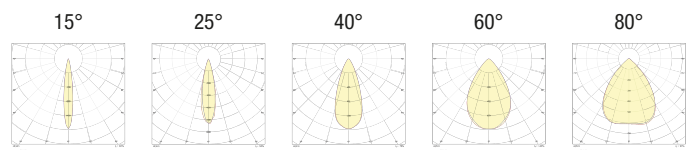
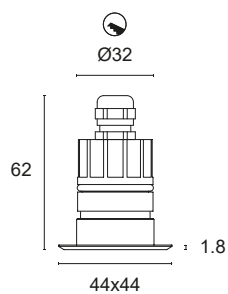

 **MADE IN ITALY**





### BASIC CODES

**L405.**







### LIGHT BEAM

-  **15** 15°
-  **25** 25°
-  **40** 40°
-  **60** 60°
-  **80** 80°

### GLASS

-  **T** Transparent
-  **S** Brushed

### LED COLOUR

-  **BN** 4000K
-  **BC** 3000K
-  **CC** 2700K
-  **BL** Blue
-  **VE** Green
-  **RO** Red
-  **AM** "Wine" Amber

### POWER

- 3 1x1W - 350mA - 135 lm**
- 5 1x2W - 500mA - 216 lm**



Code example:

DEHO Q + Light Beam 25° + Clear Glass 3000k +1W = Code: L405.25TBC3

# DARDO 2

## L502.



Flush-fitted in polished 304 stainless steel with power LED for accent, decoration, courtesy or step marker lighting. Choice of secondary optics. Can be fitted in the floor, wall or in plasterboard indoors and outdoors. Mounting with formwork or ring with springs.

Power LED CRI>80

Power: 3W@350mA - 6W@500mA

Lumen: 405Lm@350mA - 648Lm@500mA

350mA - 500mA constant current power supply

Series connection, 50 cm cable

Constant voltage power supplies p. 232 - 233

Installation accessories page 271

Dimming Accessories page 249

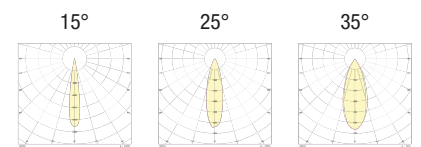
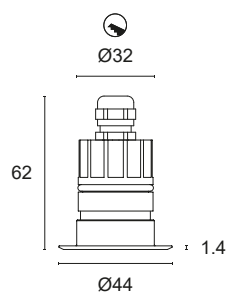

 **MADE IN ITALY**





### BASIC CODES

**L502.**







### LIGHT BEAM

-  **15** 15°
-  **25** 25°
-  **35** 35°

### GLASS

-  **T** Transparent
-  **S** Brushed

### LED COLOUR

-  **BN** 4000K
-  **BC** 3000K
-  **CC** 2700K
-  **BL** Blue
-  **VE** Green
-  **RO** Red
-  **AM** "Wine" Amber

### POWER

- 3 3x1W - 350mA - 405 lm**
- 5 3x2W - 500mA - 648 lm**



Code example:

DARDO 2 + Light Beam 2=15° + Clear Glass 3000k +3W = Code: L502.15TBC3

# DARDO 3

L503.



Flush-fitted in polished 304 steel with powerful LEDs suitable for decorative lighting and as step markers. Anti-glare radial diffuser, can be installed indoors and outdoors. Mounting with formwork for brickwork.

Power LED CRI>80

Power: 3W@350mA - 6W@500mA

Lumen: 405Lm@350mA - 648Lm@500mA

350mA - 500mA constant current power supply

Series connection, 50 cm cable

Constant voltage power supplies p. 232 - 233

Installation accessories page 271

Dimming Accessories page 249



 **MADE IN ITALY**

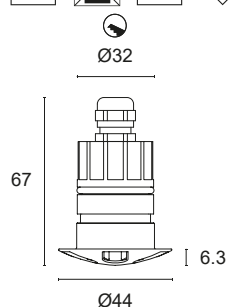
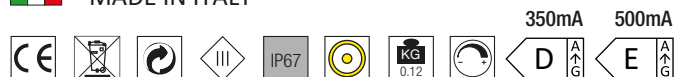







BASIC CODES

**L503.**

LIGHT BEAM

 **R5** Radial 5 apertures

LED COLOUR

-  **BN** 4000K
-  **BC** 3000K
-  **CC** 2700K
-  **BL** Blue
-  **VE** Green
-  **RO** Red
-  **AM** "Wine" Amber



POWER

**3 3x1W - 350mA - 405 lm**

**5 3x2W - 500mA - 648 lm**

Code example:

DARDO 3 + radial light beam 5 apertures + 3000K + 3W = Code: L503.R5BC3

# DARDO Q

## L504.



Flush-fitted in polished 304 stainless steel with power LED for accent, decoration, courtesy or step marker lighting. Choice of secondary optics. Can be fitted in the floor, wall or in plasterboard indoors and outdoors. Mounting with formwork or ring with springs.

Power LED CRI>80  
Power: 3W@350mA - 6W@500mA  
Lumen: 405Lm@350mA - 648Lm@500mA  
350mA - 500mA constant current power supply  
Series connection, 50 cm cable

Constant voltage power supplies p. 232 - 233  
Installation accessories page 271  
Dimming Accessories page 249



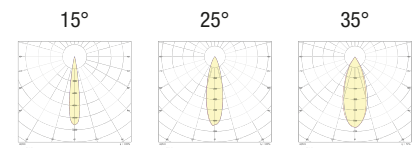
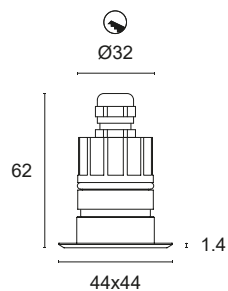

 **MADE IN ITALY**



### BASIC CODES

**L504.**







### LIGHT BEAM

-  **15** 15°
-  **25** 25°
-  **35** 35°

### GLASS

-  **T** Transparent
-  **S** Brushed

### LED COLOUR

-  **BN** 4000K
-  **BC** 3000K
-  **CC** 2700K
-  **BL** Blue
-  **VE** Green
-  **RO** Red
-  **AM** "Wine" Amber

### POWER

- 3 3x1W - 350mA - 405 lm**
- 5 3x2W - 500mA - 648 lm**



Code example:  
DARDO Q + Light Beam 15° + Clear Glass + 3000k +3W = Code: L504.15TBC3



# ACSO 1

## L601.



Polished 304 steel recessed light with power LEDs for primary floor lighting of green areas and architectural facades.  
Choice of secondary optics. Can be flush fitted indoors and outdoors  
Mounting with formwork or ring with springs.

Power LED CRI>80

Power: 4W@350mA - 8W@500mA

Lumen: 540lm@350mA - 864lm@500mA

350mA - 500mA constant current power supply

Series connection, 50 cm cable

Constant voltage power supplies p. 232 - 233

Installation accessories page 270

Dimming Accessories page 249



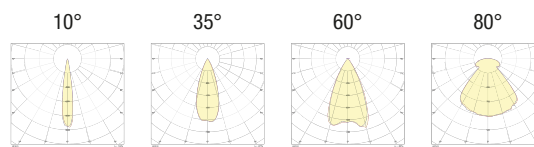
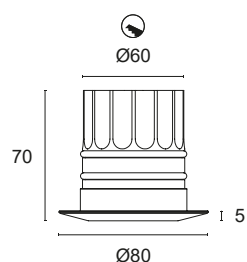

 **MADE IN ITALY**



### BASIC CODES

**L601.**







### LIGHT BEAM

-  **10** 10°
-  **35** 35°
-  **60** 60°
-  **80** 80°

### GLASS

-  **T** Transparent
-  **S** Brushed

### LED COLOUR

-  **BN** 4000K
-  **BC** 3000K
-  **CC** 2700K
-  **BL** Blue
-  **VE** Green
-  **RO** Red
-  **AM** "Wine" Amber

### POWER

- 3 4x1W - 350mA - 540 lm**
- 5 4x2W - 500mA - 864 lm**



Approved by  
CIVIC

Code example:

ACSO 1 + Light Beam 35° + Clear Glass + 4000k +4W = Code: L601.35TBN3



# ACSO 2

## L602.



Flush-fitted in polished 304 stainless steel with power LED for accent and step marker lighting. Opal diffuser. Can be fitted in the floor or on the wall indoors and outdoors, mounting with formwork.

Power LED CRI>80

Power: 4W@350mA - 8W@500mA

Lumen: 540lm@350mA - 864lm@500mA

350mA - 500mA constant current power supply

Series connection, 50 cm cable

Constant voltage power supplies p. 232 - 233

Installation accessories page 270

Dimming Accessories page 249



 **MADE IN ITALY**

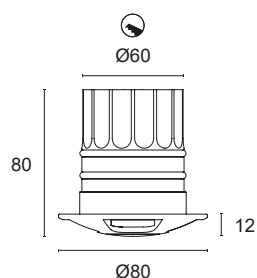
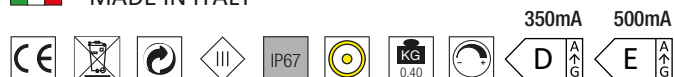







**BASIC CODES**

**L602.**

**LIGHT BEAM**

 **R4** Radial 4 apertures

**LED COLOUR**

-  **BN** 4000K
-  **BC** 3000K
-  **CC** 2700K
-  **BL** Blue
-  **VE** Green
-  **RO** Red
-  **AM** "Wine" Amber



**POWER**

**3 4x1W - 350mA - 540 lm**

**5 4x2W - 500mA - 864 lm**

Code example:

ACSO 2 + radial light beam 4 apertures + 3000K + 4W = Code: L602.R4BC3

# ACSO 3

## L603.



Flush-fitted in polished 304 stainless steel with power LED for accent or step marker lighting. Asymmetrical optics. Can be fitted in the floor indoors and outdoors, mounting with formwork.

Power LED CRI>80

Power: 1W@350mA - 2W@500mA

Lumen: 135lm@350mA - 216lm@500mA

350mA - 500mA constant current power supply

Series connection, 50 cm cable

Constant voltage power supplies p. 232 - 233

Installation accessories page 270

Dimming Accessories page 249



 **MADE IN ITALY**

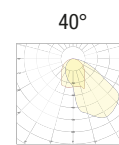
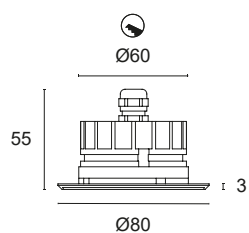

### BASIC CODES

**L603.**







### LIGHT BEAM

 **40** 40° Asymmetric

### GLASS

 **T** Transparent

### LED COLOUR

-  **BN** 4000K
-  **BC** 3000K
-  **CC** 2700K
-  **BL** Blue
-  **VE** Green
-  **RO** Red
-  **AM** "Wine" Amber



Approved by  
CIVIC

### POWER

**3 1x1W - 350mA - 135 lm**  
**5 1x2W - 500mA - 216 lm**

Code example:

ACSO 3 + Light Beam 40° + Clear Glass 3000k +1W = Code: L603.40TBC3

# ACRUX 1

L701.



Turned 304 steel recessed light with COB LEDs for primary floor lighting of green areas and architectural facades. Choice of secondary optics. Can be flush fitted indoors and outdoors Mounting with formwork or ring with springs.

COB LED CRI>90

Power: 7W@200mA

Lumen: 916Lm@200mA

200mA constant current power supply

Series connection, 50 cm cable

Constant voltage power supplies p. 234

Installation accessories page 270

Dimming Accessories page 249



 **MADE IN ITALY**

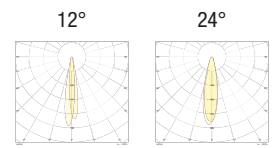
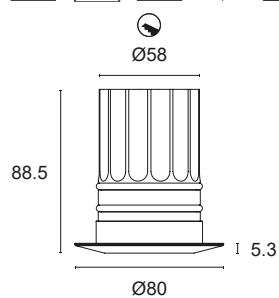

BASIC CODES

**L701.**



LIGHT BEAM

-  **12** 12°
-  **24** 24°

GLASS

-  **T** Transparent
-  **S** Brushed

LED COLOUR

-  **BN** 4000K
-  **BC** 3000K
-  **CC** 2700K

Code example:

ACRUX 1 + Light Beam 12° + Clear Glass + 4000k = Code: L701.12TBC





## 316 L RECESSED LIGHTS

DEHO 1 L .....	80
DEHO 1 L Q .....	81
DEHO 2 L .....	82
DEHO 3 L .....	83
DEHO 4 L .....	84
DEHO 5 L .....	85
DEHO Q L .....	86



# DEHO 1 L

## L41L.

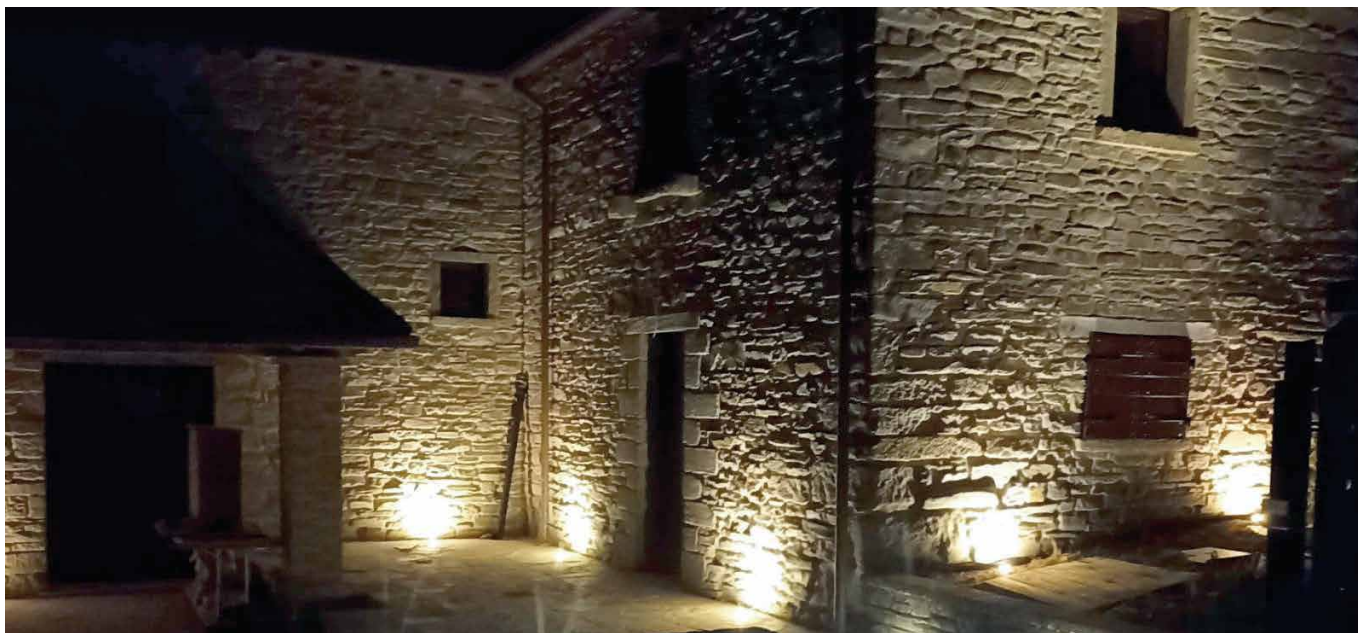

Recessed with heat sink and turned 316L stainless steel ring, WICOP LED for diffused accent, decoration, courtesy or step marker lighting. Opal diffuser. Can be fitted in the floor and on the wall indoors and outdoors, mounting with formwork.

WICOP LED CRI>80  
Power: 2W@12Vdc  
Lumen: 216Lm@12Vdc  
Constant 12Vdc voltage supply  
Parallel connection, 50 cm cable

Constant voltage power supplies page 236  
Installation accessories page 271  
Dimming Accessories page 249



 **MADE IN ITALY**

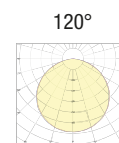
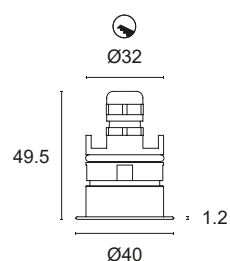

**BASIC CODES**

**L41L.**

**LED COLOUR**

- BN** 4000K
- BC** 3000K
- CC** 2700K

Code example:  
DEHO 1 L + 4000K = Code: L41L.BN

# DEHO 1 L Q

## L41LQ.



Recessed with heat sink and turned 316L stainless steel ring, WICOP LED for diffused accent, decoration, courtesy or step marker lighting. Opal diffuser. Can be fitted in the floor and on the wall indoors and outdoors, mounting with formwork.

WICOP LED CRI>80  
Power: 2W@12Vdc  
Lumen: 216Lm@12Vdc  
Constant 12Vdc voltage supply  
Parallel connection, 50 cm cable

Constant voltage power supplies page 236  
Installation accessories page 271  
Dimming Accessories page 249



 **MADE IN ITALY**

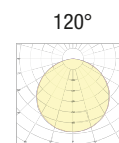
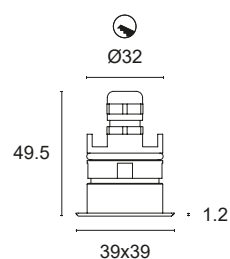

**BASIC CODES**

**L41LQ.**

**LED COLOUR**

- BN** 4000K
- BC** 3000K
- CC** 2700K

Code example:  
DEHO 1 L Q + 4000K = Code: L41LQ.BN

# DEHO 2 L

## L402L.



Recessed light with polished 316L stainless steel ring and anticorodal anodised aluminium heat sink, power LED for accent, decoration, courtesy or step marker lighting. Choice of secondary optics. Can be fitted in the floor, wall or in plasterboard indoors and outdoors. Mounting with formwork or ring with springs.

Power LED CRI>80  
Power: 1.6W@24Vdc  
Lumen: 132Lm@24Vdc  
Constant 24Vdc voltage supply  
Parallel connection, 50 cm cable

Constant voltage power supplies page 237  
Installation accessories page 271  
Dimming Accessories page 249

 **MADE IN ITALY**

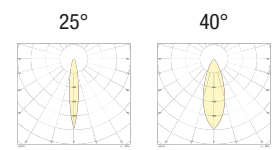
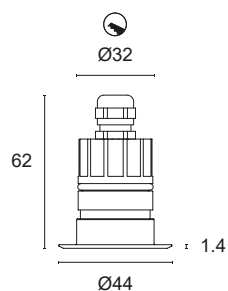



### BASIC CODES

**L402L.**



### LIGHT BEAM

-  **25** 25°
-  **40** 40°

### GLASS

-  **T** Transparent
-  **S** Brushed

### LED COLOUR

-  **BN** 4000K
-  **BC** 3000K
-  **CC** 2700K

Code example:

DEHO 2 L+ Light Beam 25° + Clear Glass + 3000k = Code: L402L.25TBC



# DEHO 3 L

## L403L.



Recessed light with polished 316L stainless steel ring and anticorodal anodised aluminium heat sink, power LED for accent, decoration, courtesy and step marker lighting. Anti-glare radial diffuser, can be installed indoors and outdoors. Mounting with formwork for brickwork.

Power LED CRI>80  
Power: 1.6W@24Vdc  
Lumen: 132Lm@24Vdc  
Constant 24Vdc voltage supply  
Parallel connection, 50 cm cable

Constant voltage power supplies page 237  
Installation accessories page 271  
Dimming Accessories page 249

 **MADE IN ITALY**

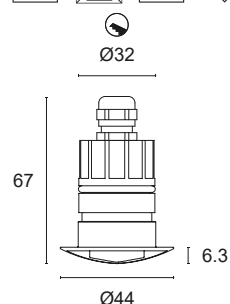



BASIC CODES

**L403L.**

LIGHT BEAM

 **R1** Radial 1 aperture

LED COLOUR

 **BN** 4000K  
 **BC** 3000K  
 **CC** 2700K



Code example:  
DEHO 3 L + radial light beam 1 aperture + 3000K = Code: L403L.R1BC



# DEHO 4 L

## L404L.



Recessed light with polished 316L stainless steel ring and anticorodal anodised aluminium heat sink, power LED for accent, decoration, courtesy and step marker lighting. Anti-glare radial diffuser, can be installed indoors and outdoors. Mounting with formwork for brickwork.

Power LED CRI>80  
Power: 1.6W@24Vdc  
Lumen: 132Lm@24Vdc  
Constant 24Vdc voltage supply  
Parallel connection, 50 cm cable

Constant voltage power supplies page 237  
Installation accessories page 271  
Dimming Accessories page 249

 **MADE IN ITALY**

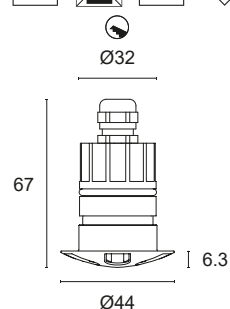



BASIC CODES

**L404L.**

LIGHT BEAM

 **R5** Radial 5 apertures

LED COLOUR

 **BN** 4000K  
 **BC** 3000K  
 **CC** 2700K



Code example:

DEHO 4 L + radial light beam 5 aperture + 3000K = Code: L404L.R5BC

# DEHO 5 L

## L402BL.



Recessed light with polished 316L stainless steel ring and anticorodal anodised aluminium heat sink, power LED for accent, decoration, courtesy and step marker lighting. Anti-glare radial diffuser, can be installed indoors and outdoors. Mounting with formwork for brickwork.

Power LED CRI>80  
Power: 1.6W@24Vdc  
Lumen: 132Lm@24Vdc  
Constant 24Vdc voltage supply  
Parallel connection, 50 cm cable

Constant voltage power supplies page 237  
Installation accessories page 271  
Dimming Accessories page 249

 **MADE IN ITALY**

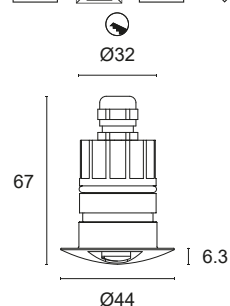



BASIC CODES

**L402BL.**

LIGHT BEAM

 **R2** Radial 2 apertures

LED COLOUR

 **BN** 4000K  
 **BC** 3000K  
 **CC** 2700K



Code example:

DEHO 5 L + radial light beam 2 apertures + 3000K = Code: L402BL.R2BC

# DEHO Q L

## L405L.



Recessed light with polished 316L stainless steel ring and anticorodal anodised aluminium heat sink, power LED for accent, decoration, courtesy or step marker lighting. Choice of secondary optics. Can be fitted in the floor, wall or in plasterboard indoors and outdoors. Mounting with formwork or ring with springs.

Power LED CRI>80  
Power: 1.6W@24Vdc  
Lumen: 132Lm@24Vdc  
Constant 24Vdc voltage supply  
Parallel connection, 50 cm cable

Constant voltage power supplies page 237  
Installation accessories page 271  
Dimming Accessories page 249

 **MADE IN ITALY**

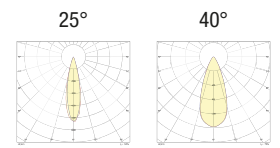
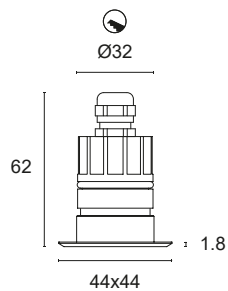

BASIC CODES

**L405L.**



LIGHT BEAM

-  **25** 25°
-  **40** 40°

GLASS

-  **T** Transparent
-  **S** Brushed

LED COLOUR

-  **BN** 4000K
-  **BC** 3000K
-  **CC** 2700K

Code example:

DEHO Q L+ Light Beam 25° + Clear Glass + 3000k = Code: L405L.25TBC









## PROJECTORS

DUVAR .....	90
VERTIGO .....	91
ZEPPELIN .....	92

# DUVAR

## L23.



Directional projector in anticorodal anodised or decorated aluminium with power LED source. Suitable for decorative, accent, courtesy and general lighting. Choice of secondary optics, can be installed indoors and outdoors. Screw mounting with wall base or stake.

Power LED CRI>80  
 Power: 3W@350mA - 6W@500mA  
 Lumen: 405Lm@350mA - 648Lm@500mA  
 350mA - 500mA constant current power supply  
 Series connection, 50 cm cable

Constant current power supplies page 232-233  
 Installation accessories page 272  
 Dimming Accessories page 249

**MADE IN ITALY**

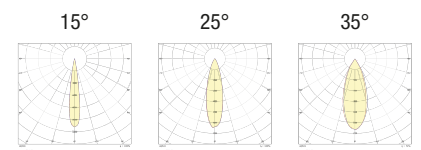
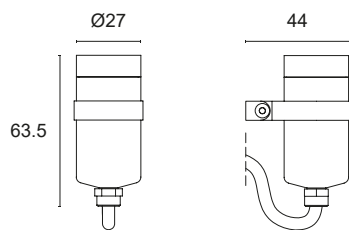
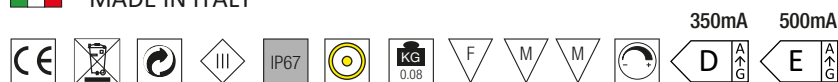

### BASIC CODES

**L23.**

### FINISHES

- 2** Matt black
- 7** Brushed aluminium

### LIGHT BEAM

- 15** 15°
- 25** 25°
- 35** 35°

### LED COLOUR

- BN** 4000K
- BC** 3000K
- CC** 2700K
- BL** Blue
- VE** Green
- RO** Red
- AM** "Wine" Amber



Approved by  
CIVIC

### POWER

- 3** 3x1W - 350mA - 405 lm
- 5** 3x2W - 500mA - 648 lm

Code example:  
 DUVAR + Brushed Aluminium + 15° light beam + 4000K + 3W = Code: L23.715BN3



# VERTIGO

## L14.



Directional projector in anticorrosion anodised or decorated aluminium with COB LEDs CRI>90. Suitable for primary and decorative lighting of architectural facades, gardens and monuments. Choice of secondary optics, can be installed indoors and outdoors. Screw mounting on bracket.

Power LED CRI>90

Power: 7W@200mA

Lumen: 916Lm@200mA

200mA constant current power supply

Series connection, 50 cm cable

Constant current power supplies page 234

Dimming Accessories page 249



 **MADE IN ITALY**

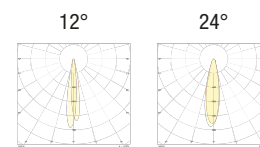
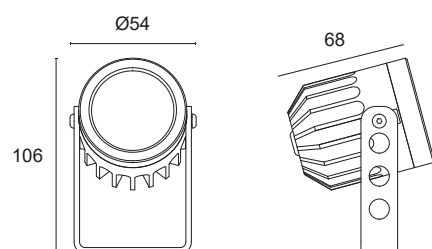







### BASIC CODES

**L14.**





### FINISHES

-  **2** Matt black
-  **7** Brushed aluminium

### LIGHT BEAM

-  **12** 12°
-  **24** 24°
-  **10** 10°
-  **35** 35°
-  **60** 60°
-  **80** 80°

### LED COLOUR

-  **BN** 4000K
  -  **BC** 3000K
  -  **CC** 2700K
  -  **AM** "Wine" Amber
-  Approved by CIVIC
- 3** 4x1W - 350mA
  - 5** 4x2W - 500mA

Code example:

VERTIGO + Brushed Aluminium + 12° light beam + 4000K + 3W = Code: L14.712BN



# ZEPPELIN

L06.



Directional projector in anticorrosive anodised or decorated aluminium with power LED source. Suitable for primary and decorative lighting of architectural facades, gardens and monuments. Choice of secondary optics, can be installed indoors and outdoors. Screw mounting on bracket.

Power LED CRI>80

Power: 9W@350mA - 18W@500mA

Lumen: 1215lm@350mA - 1944lm@500mA

350mA - 500mA constant current power supply

Series connection, 50 cm cable

Constant current power supplies page 232-233

Dimming Accessories page 249



 **MADE IN ITALY**

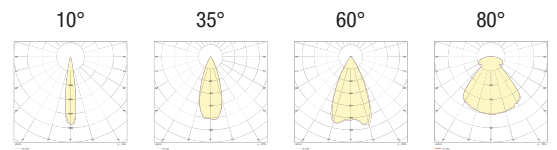
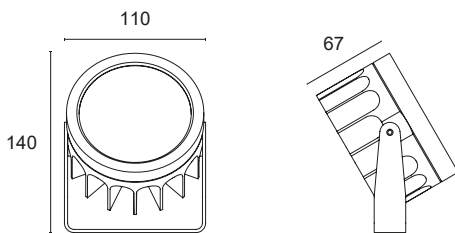





**BASIC CODES**

**L06.**







**FINISHES**

-  **2** Matt black
-  **7** Brushed aluminium

**LIGHT BEAM**

-  **10** 10°
-  **35** 35°
-  **60** 60°
-  **80** 80°

**LED COLOUR**

-  **BN** 4000K
-  **BC** 3000K
-  **CC** 2700K
-  **BL** Blue
-  **VE** Green
-  **RO** Red
-  **AM** "Wine" Amber

**POWER**

- 3 9x1W - 350mA - 1215 lm**
- 5 9x2W - 500mA - 1944 lm**



Code example:

ZEPPELIN + Matt black + Light beam 10° + 3000K + 9W = Code: L06.210BC3









## DECORATIVE TECHNICAL LIGHTING

PIXEL 1	96
ROMY	97
SARY	98
ISA	99
LILLY	100
EVA	101
LINEA	102
QUADRA Q1	103
QUADRA Q2	104
QUADRA Q3	105
QUADRA Q4	106
QUADRA R1	107
QUADRA R2	108
QUADRA R3	109
REM	110
CISO P31 CEILING LIGHT	111
CISO P33 CEILING LIGHT	112
CISO P50 CEILING LIGHT	113
CISO P80 CEILING LIGHT	114
CISO S31 PENDANT LIGHT	115
CISO S33 PENDANT LIGHT	116
CISO S50 PENDANT LIGHT	117
CISO S80 PENDANT LIGHT	118
CEILING ROSES FOR OTHER CISO COMPOSITIONS	119



# PIXEL 1

## F10.



Directional lamp in polished, flexible aluminium suitable for reading, decoration or courtesy lighting. Choice of secondary optics, can be installed indoors. Screw mounting with base or on wall.

Power LED CRI>80

Power: 1W@350mA

Lumen: 135Lm@350mA

350mA constant current power supply

Constant current power supply included

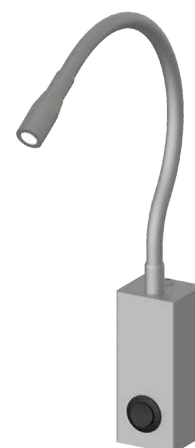

 **MADE IN ITALY**



**F10. base w/box**

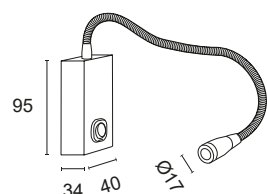

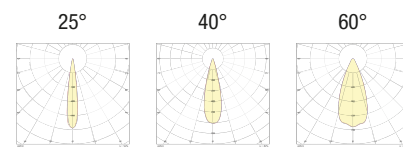
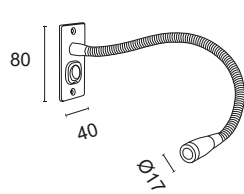

**F10. flat base**





**BASIC CODES**

**F10.**







**FINISHES**

-  **6** Chrome
-  **7** Brushed aluminium

**LIGHT BEAM**

-  **25** 25°
-  **40** 40°
-  **60** 60°

**LED COLOUR**

-  **BN** 4000K
-  **BC** 3000K
-  **CC** 2700K
-  **BL** Blue
-  **VE** Green
-  **RO** Red
-  **AM** "Wine" Amber



Approved by  
CIVIC

**BASE W/BOX AND SWITCH**

- BX** without switch
- BB** with white switch
- BB** with black switch

**FLAT BASE AND SWITCH**

- PX** without switch
- PB** with white switch
- PN** with black switch

Code example:

PIXEL 1 + Brushed aluminium + Light beam 25° + 3000K + Flat base white switch = Code: F10.725BCPB

# ROMY

## ROMY.



Mirror lamp made entirely of decorated aluminium. Suitable for frame application on mirrors, can be installed in partially protected indoor areas. Excellent lumen/watt ratio.

LED SMD2835 CRI>90

Power: 16.8W/m

Lumen: 1900 - 2000 lm/m

Constant voltage supply 24Vdc

Power supply included and built in

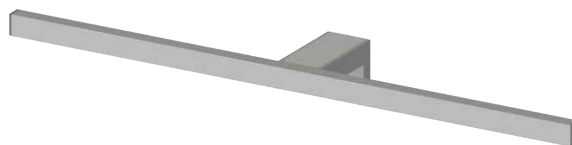

 **MADE IN ITALY**

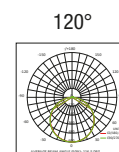
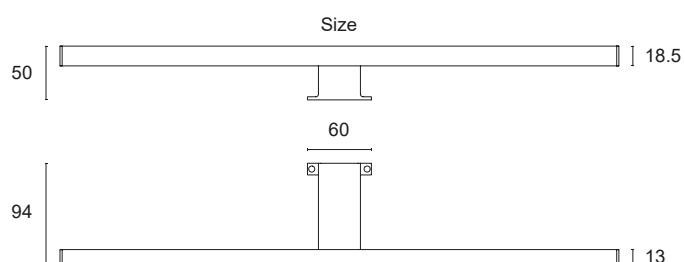
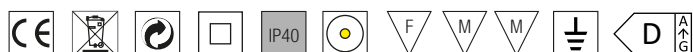

### BASIC CODES

**ROMY.**

### FINISHES

- 1 White
- 2 Matt black
- 5 Gloss aluminium
- 6 Chrome
- 7 Brushed aluminium

### SIZE

- A** 320mm 5W 660 lm
- B** 520mm 8W 1100 lm

### LED COLOUR

- BN** 4000K
- BC** 3000K
- CC** 2700K

Code example:

ROMY + Chrome + 320mm + 4000K = Code: ROMY.6ABN

# SARY

## SARY.



Mirror lamp made entirely of decorated aluminium. Suitable for frame application on mirrors, can be installed in partially protected indoor areas. Excellent lumen/watt ratio.

LED SMD2835 CRI>90

Power: 20.2W/m

Lumen: 2100 - 2500 lm/m

Constant voltage supply 24Vdc

Power supply included and remote

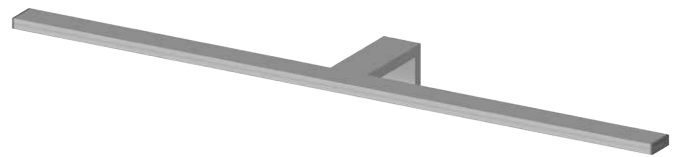

 **MADE IN ITALY**

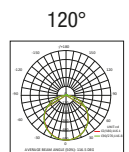
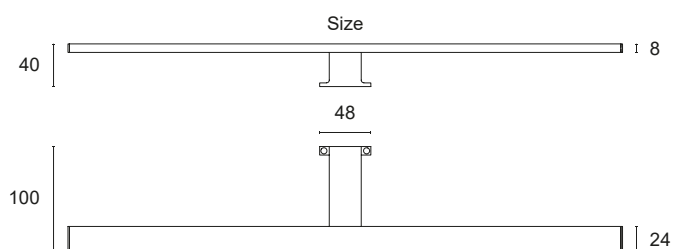

### BASIC CODES

**SARY.**

### FINISHES

- 1 White
- 2 Matt black
- 6 Chrome
- 7 Brushed aluminium

### SIZE

- A** 320mm 6W 750 lm
- B** 520mm 10W 1250 lm

### LED COLOUR

- BN** 4000K
- BC** 3000K
- CC** 2700K

Code example:

SARY + Chrome + 320mm + 4000K = Code: SARY.6ABN



Mirror lamp made entirely of decorated aluminium and steel. Suitable for wall application on mirrors, can be installed in partially protected indoor areas. Excellent lumen/watt ratio.

LED SMD2835 CRI>90

Power: 20.2W/m

Lumen: 2100 - 2500 lm/m

Constant voltage supply 24Vdc

Power supply included and built in



**MADE IN ITALY**

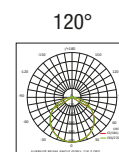
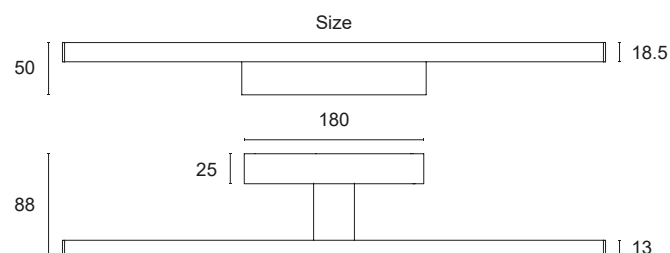
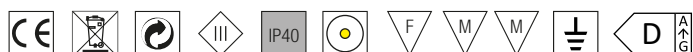

#### BASIC CODES

**ISA.**

#### FINISHES

- 1 White
- 2 Matt black
- 6 Chrome
- 7 Brushed aluminium

#### SIZE

- A** 610mm 12W 1500 lm
- B** 810mm 16W 2000 lm
- C** 1010mm\* 20W 2500 lm

\*(chrome finish not available)

#### LED COLOUR

- BN** 4000K
- BC** 3000K
- CC** 2700K

Code example:

ISA + Chrome + 610mm + 4000K = Code: ISA.6ABN



# LILLY

## LILLY.



Mirror lamp made entirely of decorated aluminium. Suitable for application on mirrors, can be installed in partially protected indoor areas. Excellent lumen/watt ratio. Mounting with clips on mirror.

LED SMD2835 CRI>90

Power: 20.2W/m

Lumen: 2100 - 2500 lm/m

Constant voltage supply 24Vdc

Power supply included and remote



 **MADE IN ITALY**

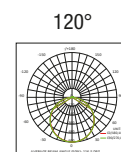
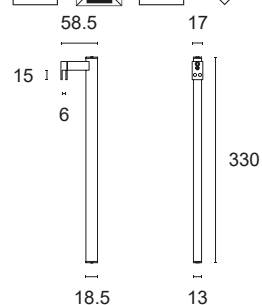
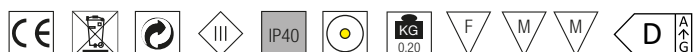

**BASIC CODES**

**LILLY.**

**FINISHES**

- 1 White
- 2 Matt black
- 5 Gloss aluminium
- 6 Chrome
- 7 Brushed aluminium

**SIZE**

**A** 330mm 6W 780 lm

**LED COLOUR**

- BN** 4000K
- BC** 3000K
- CC** 2700K

**Code example:**

LILLY + Chrome + 330mm + 4000K = Code: LILLY.6ABN

# EVA

## L33.



Dual-emission lamp in polished aluminium for accent, decoration and courtesy lighting. Choice of secondary optics, can be installed indoors and outdoors. Screw mounting with wall base.

Power LED CRI>80

Power: 2W+2W@500mA

Lumen: 216+216Lm@500mA

500mA constant current power supply

Power supply included and built in.

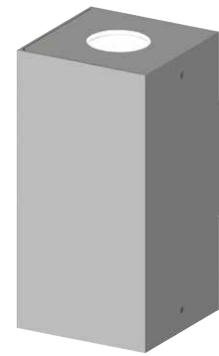

 **MADE IN ITALY**

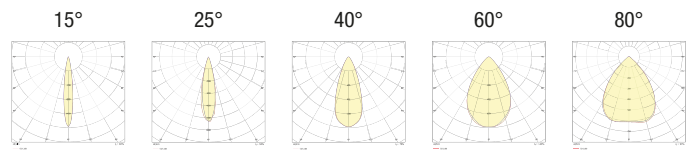
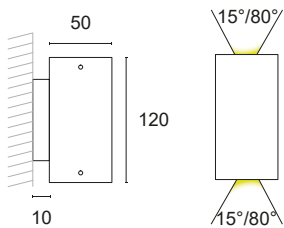

### BASIC CODES

**L33.**

### FINISHES

- 1 White
- 2 Matt black
- 7 Brushed aluminium

### 1st LIGHT BEAM

- 15 15°
- 25 25°
- 40 40°
- 60 60°
- 80 80°

### 2nd LIGHT BEAM

- 15 15°
- 25 25°
- 40 40°
- 60 60°
- 80 80°

### LED COLOUR

- BN 4000K
- BC 3000K
- CC 2700K
- BL Blue
- VE Green
- RO Red
- AM "Wine" Amber



Code example:

EVA + Matt black + 1st light beam 15°+ 2nd light beam 40°+ 4000K = Code: L33.21540BN

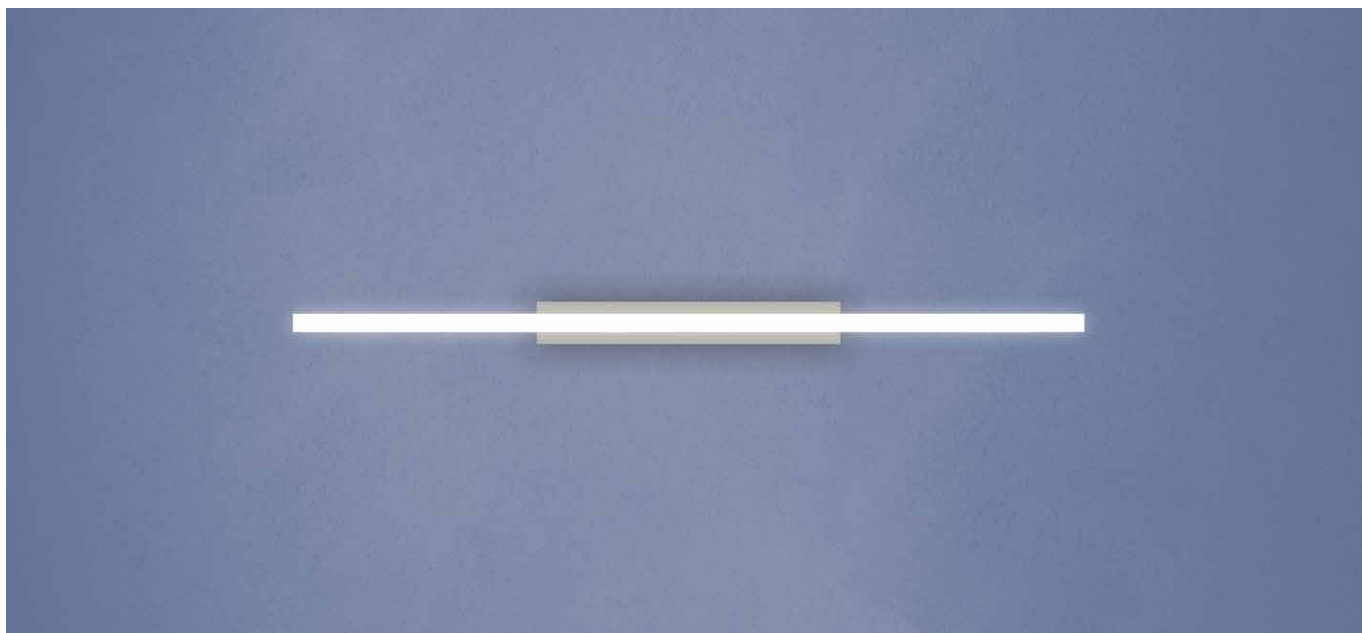

Linear ceiling lamp made entirely of decorated aluminium. Suitable as primary lighting in residential, commercial and communal spaces. Excellent lumen/watt ratio. Can be ceiling or wall mounted with screw-fixed base.

LED SMD2835 CRI>90

Power: 20.2W/m

Lumen: 2100 - 2500 lm/m

Constant voltage supply 24Vdc

Power supply included and built in

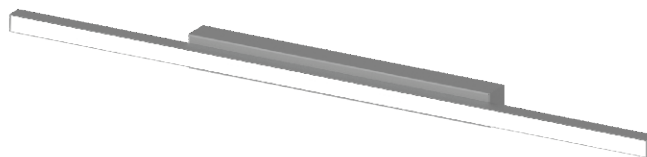

MADE IN ITALY

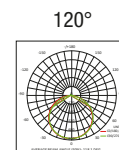
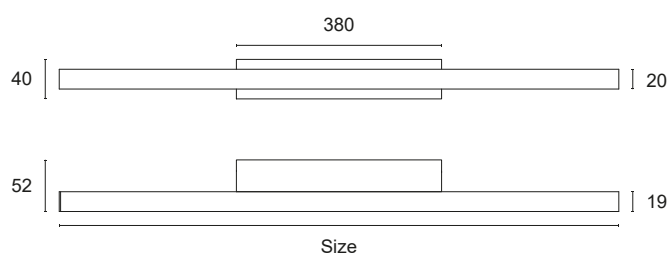
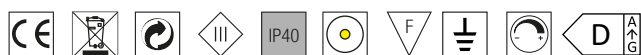

### BASIC CODES

**L1.**

### CEILING ROSE FINISHES

- 1 White
- 2 Matt black
- 7 Brushed aluminium

### PROFILE FINISHES

- 1 White
- 2 Matt black
- 7 Brushed aluminium

### SIZE

- F** 800mm 16W 2000 lm
- G** 930mm 19W 2325 lm
- H** 1010mm 20W 2525 lm
- I** 1220mm 24W 3050 lm
- L** 1480mm 30W 3700 lm
- M** 1810mm 36W 4525 lm
- N** 2020mm 40W 5050 lm

### LED COLOUR

- BN** 4000K
- BC** 3000K
- CC** 2700K

### DIFFUSER

- M** MICROPRISMATIC
- S** BRUSHED

### POWER SUPPLY

- N** ON/OFF
- P** PUSH
- D** DALI

### Code example:

LINEA + White ceiling rose + brushed aluminium profile + 1010mm + 4000K + Microprismatic diffuser + DALI = Code: L1.17HBNMD

# QUADRA Q1

Q.QY1.

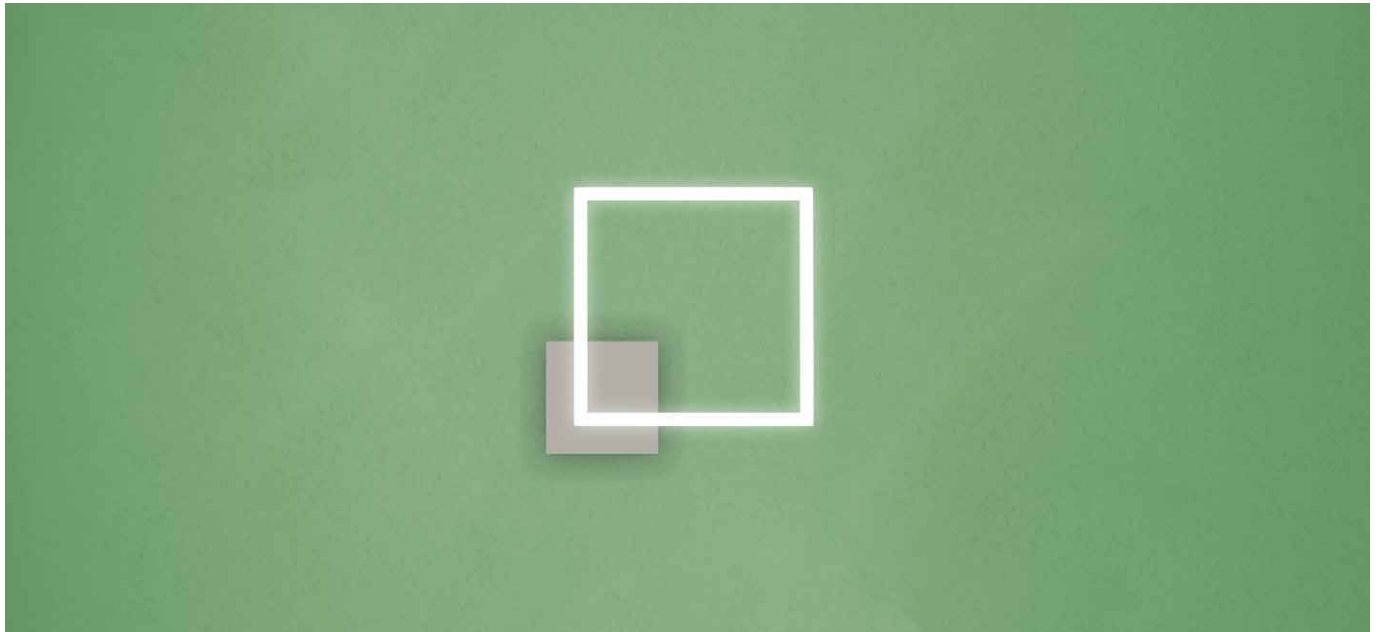

Design lamp made entirely of decorated aluminium. Suitable as primary lighting in residential, commercial and communal spaces. Excellent lumen/watt ratio. Can be ceiling or wall mounted with screw-fixed base.

LED SMD2835 CRI>90

Power: 27W

Lumen: 3200 lm

Constant voltage supply 24Vdc

Power supply included and built in

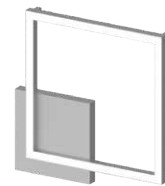

 **MADE IN ITALY**

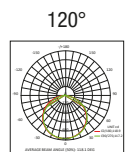
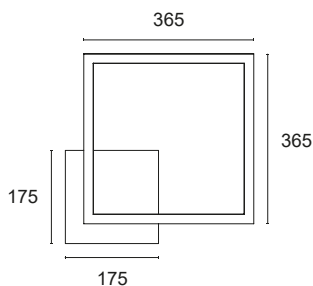

## BASIC CODES

**Q.QY1.**

## CEILING ROSE FINISHES

- 1** White
- 2** Matt black
- 7** Brushed aluminium

## PROFILE FINISHES

- 1** White
- 2** Matt black
- 7** Brushed aluminium

## LED COLOUR

- BN** 4000K
- BC** 3000K
- CC** 2700K

## DIFFUSER

- M** MICROPRISMATIC
- S** BRUSHED

## POWER SUPPLY

- N** ON/OFF
- P** PUSH
- D** DALI

## Code example:

QUADRA Q1 + White ceiling rose + brushed aluminium profile + 4000K + Microprismatic diffuser + DALI = Code: Q.QY1.17BNMD



# QUADRA Q2

Q.QY2.

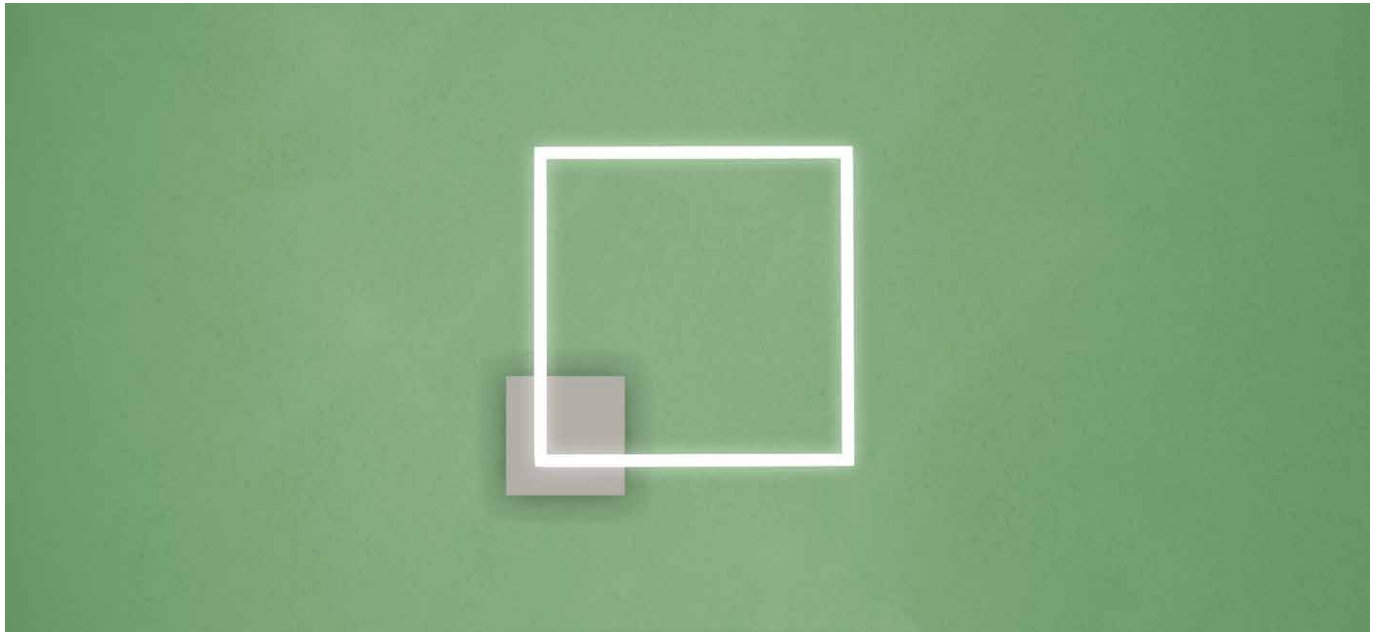

Design lamp made entirely of decorated aluminium. Suitable as primary lighting in residential, commercial and communal spaces. Excellent lumen/watt ratio. Can be ceiling or wall mounted with screw-fixed base.

LED SMD2835 CRI>90

Power: 40W

Lumen: 4800 lm

Constant voltage supply 24Vdc

Power supply included and built in

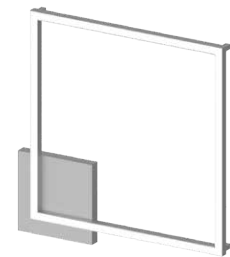

 **MADE IN ITALY**

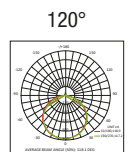
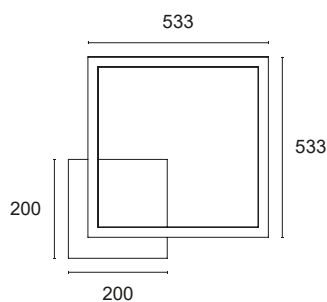

## BASIC CODES

**Q.QY2.**

## CEILING ROSE FINISHES

- 1 White
- 2 Matt black
- 7 Brushed aluminium

## PROFILE FINISHES

- 1 White
- 2 Matt black
- 7 Brushed aluminium

## LED COLOUR

- BN** 4000K
- BC** 3000K
- CC** 2700K

## DIFFUSER

- M** MICROPRISMATIC
- S** BRUSHED

## POWER SUPPLY

- N** ON/OFF
- P** PUSH
- D** DALI

Code example:

QUADRA Q2 + White ceiling rose + brushed aluminium profile + 4000K + Microprismatic diffuser + DALI = Code: Q.QY2.17BNMD

# QUADRA Q3

Q.QY3.

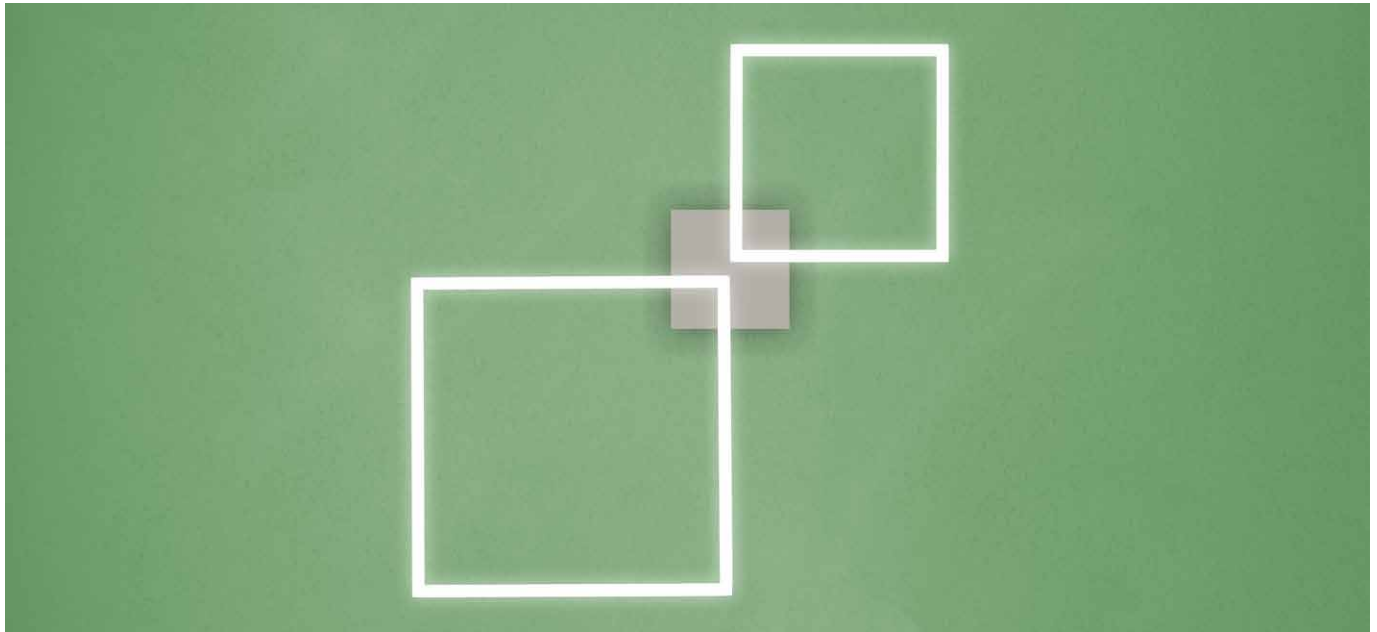

Design lamp made entirely of decorated aluminium. Suitable as primary lighting in residential, commercial and communal spaces. Excellent lumen/watt ratio. Can be ceiling or wall mounted with screw-fixed base.

LED SMD2835 CRI>90

Power: 67W

Lumen: 8000 lm

Constant voltage supply 24Vdc

Power supply included and built in

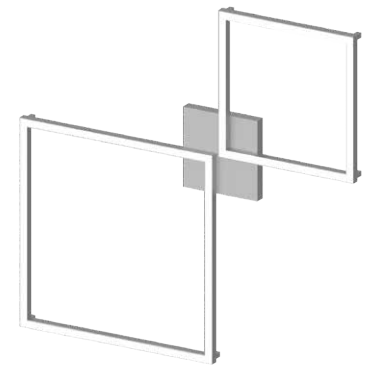

 **MADE IN ITALY**

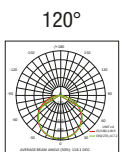
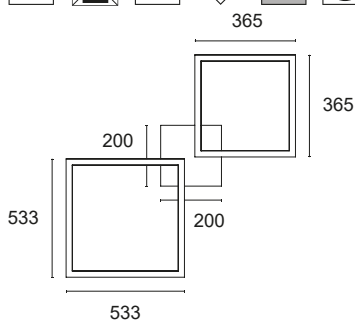

BASIC CODES

**Q.QY3.**

CEILING ROSE FINISHES

- 1 White
- 2 Matt black
- 7 Brushed aluminium

PROFILE FINISHES

- 1 White
- 2 Matt black
- 7 Brushed aluminium

LED COLOUR

- BN** 4000K
- BC** 3000K
- CC** 2700K

DIFFUSER

- M** MICROPRISMATIC
- S** BRUSHED

POWER SUPPLY

- N** ON/OFF
- P** PUSH
- D** DALI

Code example:

QUADRA Q3 + White ceiling rose + brushed aluminium profile + 4000K + Microprismatic diffuser + DALI = Code: Q.QY3.17BNMD

# QUADRA Q4

Q.QY4.

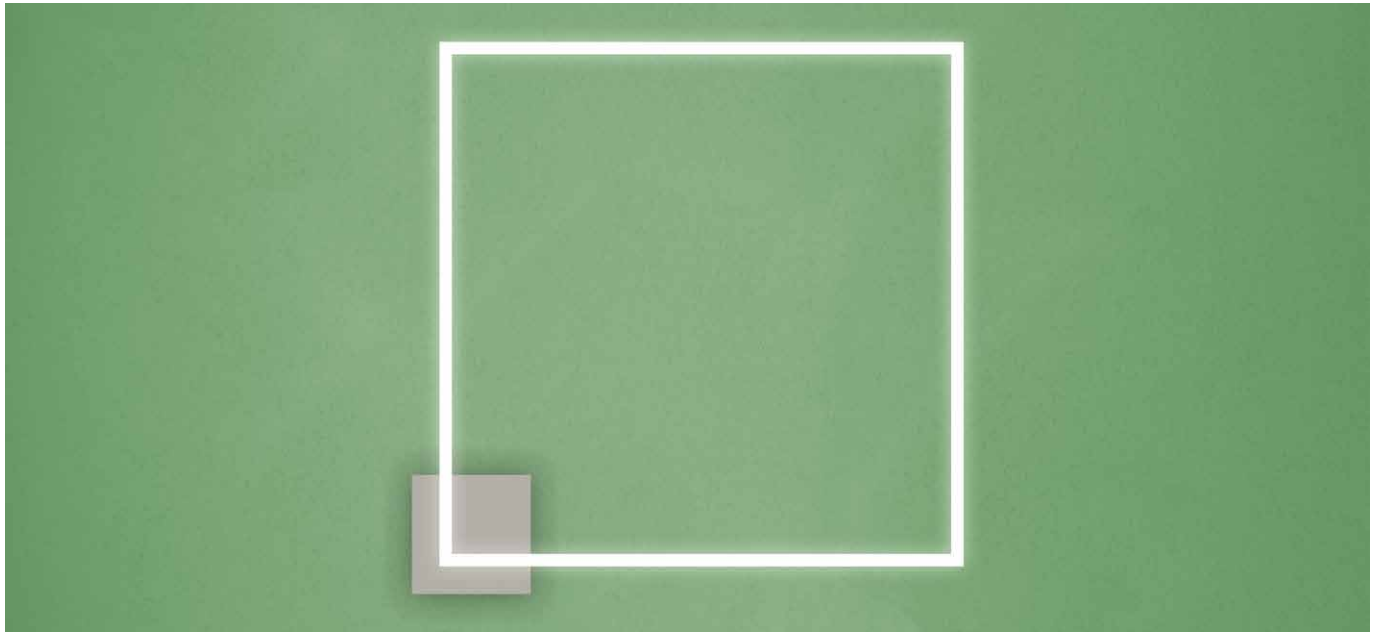

Design lamp made entirely of decorated aluminium. Suitable as primary lighting in residential, commercial and communal spaces. Excellent lumen/watt ratio. Can be ceiling or wall mounted with screw-fixed base.

LED SMD2835 CRI>90

Power: 67W

Lumen: 8000 lm

Constant voltage supply 24Vdc

Power supply included and built in

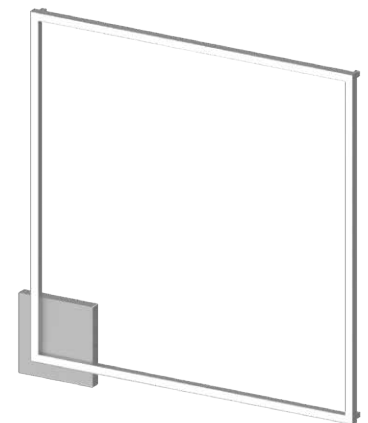

 **MADE IN ITALY**



867

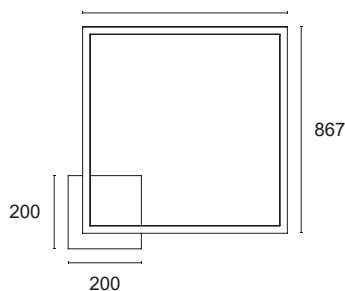

120°

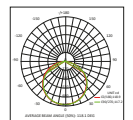

BASIC CODES

**Q.QY4.**

CEILING ROSE FINISHES

- 1 White
- 2 Matt black
- 7 Brushed aluminium

PROFILE FINISHES

- 1 White
- 2 Matt black
- 7 Brushed aluminium

LED COLOUR

- BN** 4000K
- BC** 3000K
- CC** 2700K

DIFFUSER

- M** MICROPRISMATIC
- S** BRUSHED

POWER SUPPLY

- N** ON/OFF
- P** PUSH
- D** DALI

Code example:

QUADRA Q4 + White ceiling rose + brushed aluminium profile + 4000K + Microprismatic diffuser + DALI = Code: Q.QY4.17BNMD

# QUADRA R1

Q.RY1.

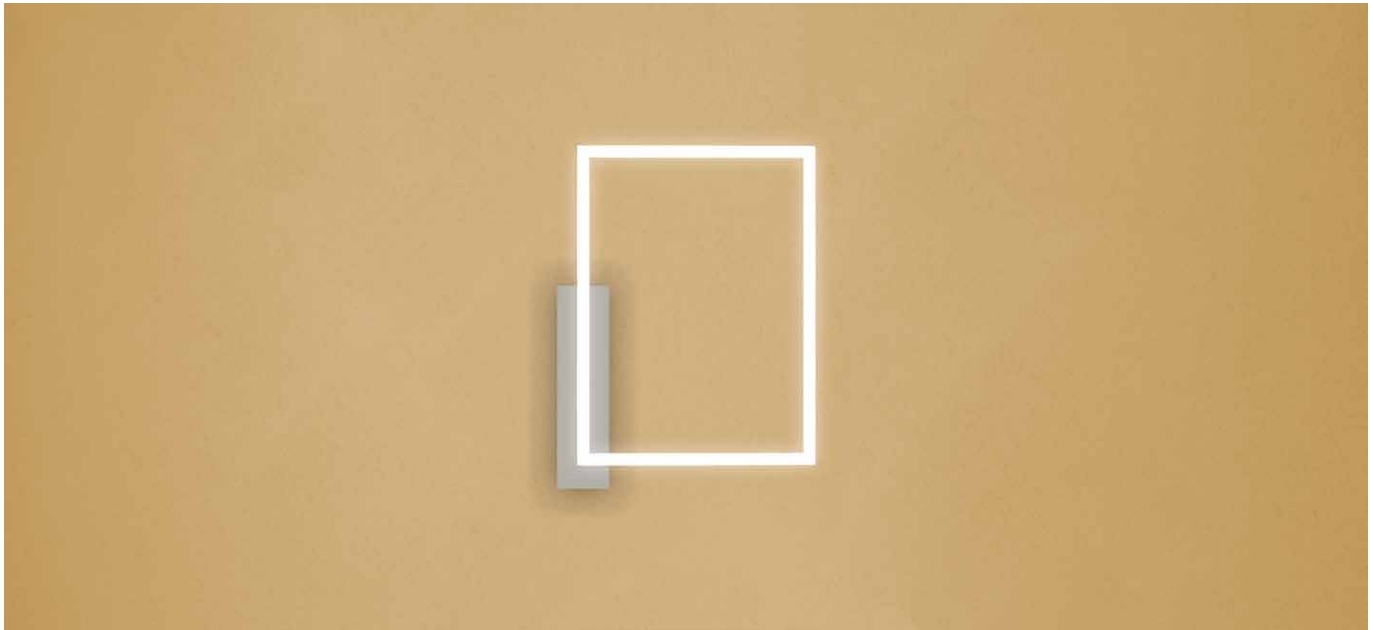

Design lamp made entirely of decorated aluminium. Suitable as primary lighting in residential, commercial and communal spaces. Excellent lumen/watt ratio. Can be ceiling or wall mounted with screw-fixed base.

LED SMD2835 CRI>90

Power: 33W

Lumen: 4000 lm

Constant voltage supply 24Vdc

Power supply included and built in

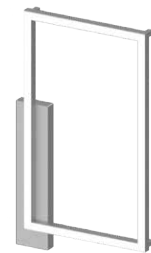

 **MADE IN ITALY**

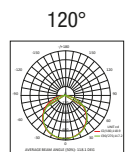
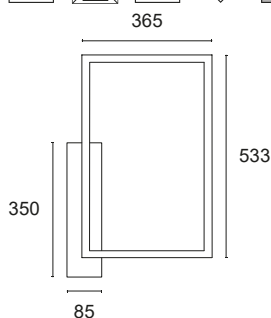

**BASIC CODES**

**Q.RY1.**

**CEILING ROSE FINISHES**

- 1 White
- 2 Matt black
- 7 Brushed aluminium

**PROFILE FINISHES**

- 1 White
- 2 Matt black
- 7 Brushed aluminium

**LED COLOUR**

- BN** 4000K
- BC** 3000K
- CC** 2700K

**DIFFUSER**

- M** MICROPRISMATIC
- S** BRUSHED

**POWER SUPPLY**

- N** ON/OFF
- P** PUSH
- D** DALI

**Code example:**

QUADRA R1 + White ceiling rose + brushed aluminium profile + 4000K + Microprismatic diffuser + DALI = Code: Q.RY1.17BNMD



# QUADRA R2

Q.RY2.

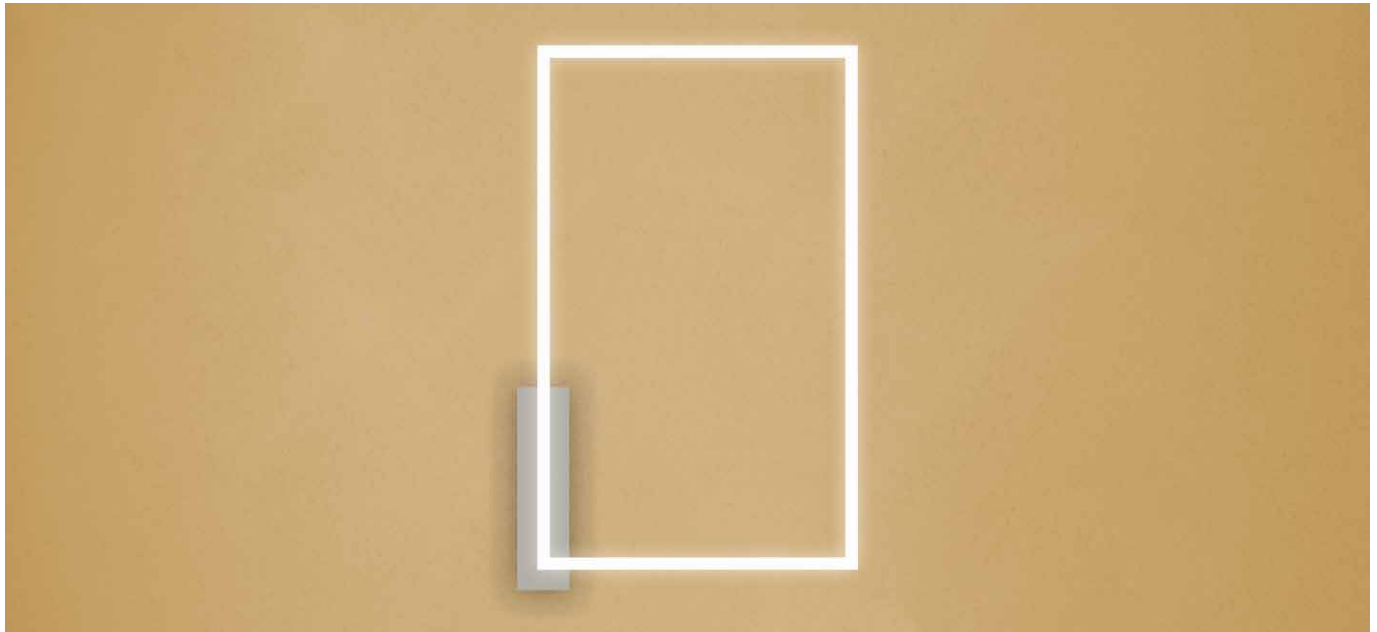

Design lamp made entirely of decorated aluminium. Suitable as primary lighting in residential, commercial and communal spaces. Excellent lumen/watt ratio. Can be ceiling or wall mounted with screw-fixed base.

LED SMD2835 CRI>90

Power: 53W

Lumen: 6300 lm

Constant voltage supply 24Vdc

Power supply included and built in

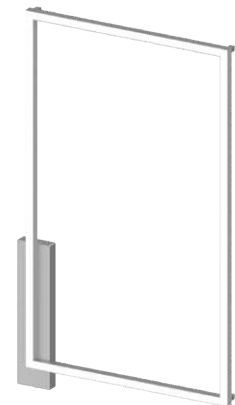

 **MADE IN ITALY**



533

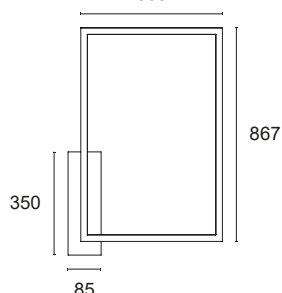

120°

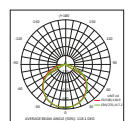

BASIC CODES

**Q.RY2.**

CEILING ROSE FINISHES

- 1 White
- 2 Matt black
- 7 Brushed aluminium

PROFILE FINISHES

- 1 White
- 2 Matt black
- 7 Brushed aluminium

LED COLOUR

- BN** 4000K
- BC** 3000K
- CC** 2700K

DIFFUSER

- M** MICROPRISMATIC
- S** BRUSHED

POWER SUPPLY

- N** ON/OFF
- P** PUSH
- D** DALI

Code example:

QUADRA R2 + White ceiling rose + brushed aluminium profile + 4000K + Microprismatic diffuser + DALI = Code: Q.RY2.17BNMD

# QUADRA R3

Q.RY3.

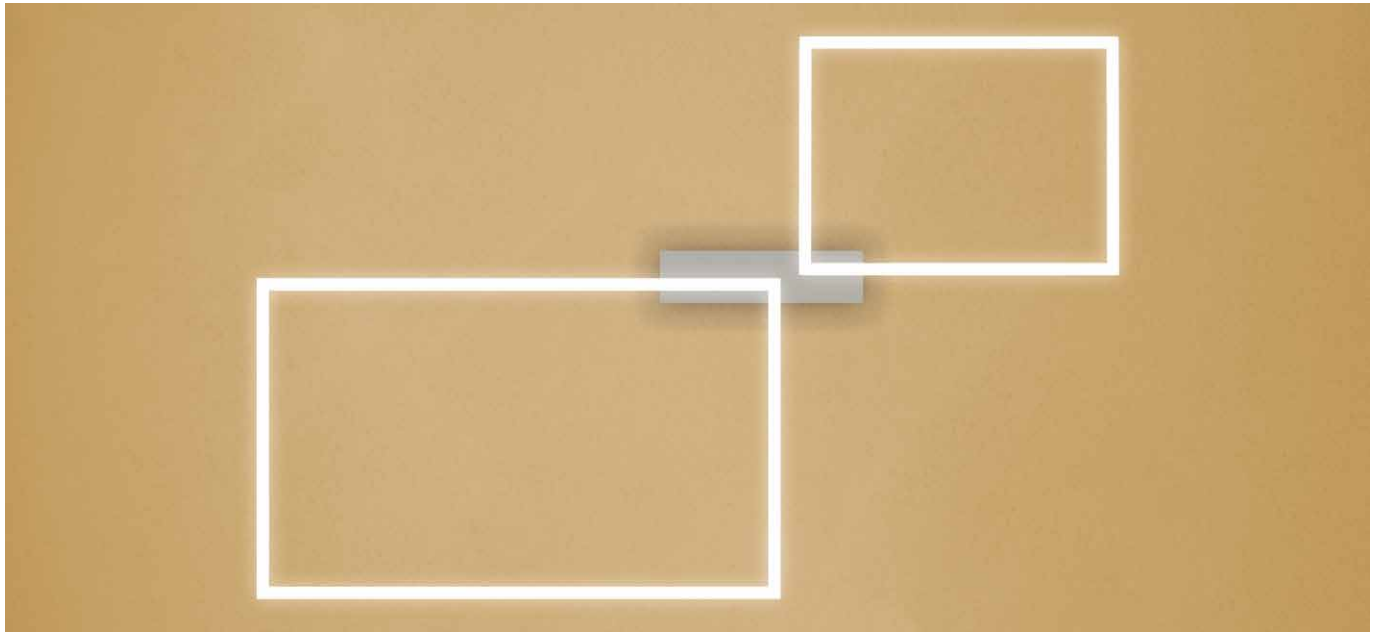

Design lamp made entirely of decorated aluminium. Suitable as primary lighting in residential, commercial and communal spaces. Excellent lumen/watt ratio. Can be ceiling or wall mounted with screw-fixed base.

LED SMD2835 CRI>90

Power: 87W

Lumen: 10500 lm

Constant voltage supply 24Vdc

Power supply included and built in

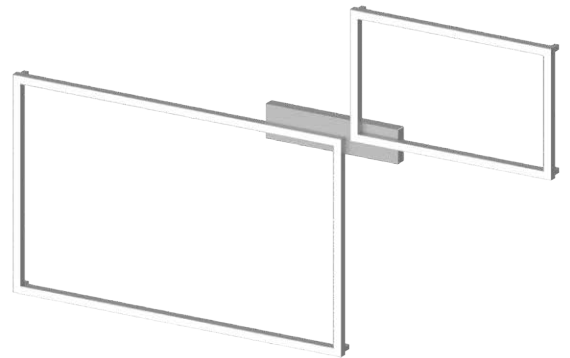

 **MADE IN ITALY**

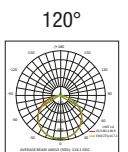
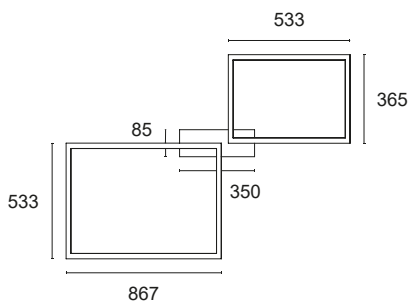

**BASIC CODES**

**Q.RY3.**

**CEILING ROSE FINISHES**

- 1 White
- 2 Matt black
- 7 Brushed aluminium

**PROFILE FINISHES**

- 1 White
- 2 Matt black
- 7 Brushed aluminium

**LED COLOUR**

- BN** 4000K
- BC** 3000K
- CC** 2700K

**DIFFUSER**

- M** MICROPRISMATIC
- S** BRUSHED

**POWER SUPPLY**

- N** ON/OFF
- P** PUSH
- D** DALI

Code example:

QUADRA R3 + White ceiling rose + brushed aluminium profile + 4000K + Microprismatic diffuser + DALI = Code: Q.RY3.17BNMD

# REM RG32.



Ø32mm decorated aluminium directional projector decorated with power LEDs for spot, decorative, reading or courtesy lighting. Choice of secondary optics, can be installed indoors. Mounting with concealed insert.

Power LED CRI>90

Power: 2W@500mA - 6W@500mA

Lumen: 216Lm@500mA - 648Lm@500mA

500mA constant current power supply

Series connection, 50 cm cable

Constant current power supplies page 233

Dimming Accessories page 249



 **MADE IN ITALY**

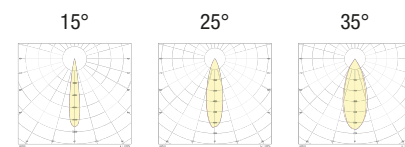
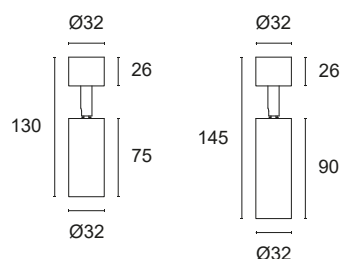

## BASIC CODES

**RG32.**

## MEASUREMENTS

**A** Ø32 - H 130mm

**B** Ø32 - H 145mm

## FINISHES

- 1** White
- 2** Matt black
- 7** Brushed aluminium
- 9** Polished gold

## LIGHT BEAM

- 15** 15°
- 25** 25°
- 35** 35°

## LED COLOUR

- BN** 4000K
- BC** 3000K
- CC** 2700K
- BL** Blue
- VE** Green
- RO** Red
- AM** "Wine" Amber

## POWER

- 3** 1x2W  
500mA - 216 lm
- 5** 3x2W  
500mA - 648 lm



Code example:

REM + H130mm + White + Light Beam 15° + 4000K + 2W = Code: RG32.A115BN3

# CISO P31 CEILING LIGHT

P31.



Ø32mm decorated aluminium cylinder ceiling light with power LEDs, suitable as accent or highlight lighting for residential, restaurant or retail environments. Choice of flush-mounted secondary optics, can be installed indoors. Mounting with concealed base.

Power LED CRI>90  
Power: 2W@500mA  
Lumen: 216Lm@500mA  
500mA constant current power supply  
Power supply included and remote

Constant current power supplies page 233  
Dimming Accessories page 249



 **MADE IN ITALY**

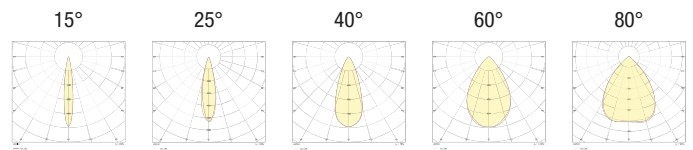
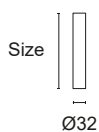

## BASIC CODES

**P31.**

## SIZE

- A** H 90mm
- B** H 180mm
- C** H 290mm
- D** H 470mm
- E** H 760mm

## FINISHES

- 1** White
- 2** Matt black
- 5** Gloss aluminium
- 7** Brushed aluminium
- 8** Gold leaf
- 9** Bond Copper

## LIGHT BEAM

- 15** 15°
- 25** 25°
- 40** 40°
- 60** 60°
- 80** 80°

## LED COLOUR

- BN** 4000K
- BC** 3000K
- CC** 2700K
- BL** Blue
- VE** Green
- RO** Red
- AM** "Wine" Amber



Approved by  
**CIVIC**

## Code example:

CISO P31 CEILING LIGHT + H470mm + White + Light Beam 15° + 4000K = Code: P31.D115BN



# CISO P33 CEILING LIGHT

P33.



Ø32mm decorated aluminium cylinder ceiling light with three power LEDs, suitable as accent or highlight lighting for residential, restaurant or retail environments. Choice of flush-mounted secondary optics, can be installed indoors. Mounting with concealed base.

Power LED CRI>90

Power: 6W@500mA

Lumen: 648Lm@500mA

500mA constant current power supply

Power supply included and remote

Constant current power supplies page 233

Dimming Accessories page 249



 **MADE IN ITALY**

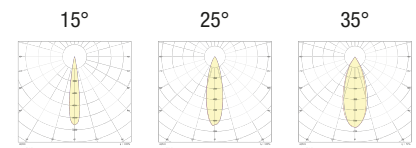
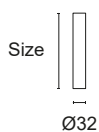

## BASIC CODES

**P33.**

## SIZE

- A** H 90mm
- B** H 180mm
- C** H 290mm
- D** H 470mm
- E** H 760mm

## FINISHES

- 1** White
- 2** Matt black
- 5** Gloss aluminium
- 7** Brushed aluminium
- 8** Gold leaf
- 9** Bond Copper

## LIGHT BEAM

- 15** 15°
- 25** 25°
- 35** 35°

## LED COLOUR

- BN** 4000K
- BC** 3000K
- CC** 2700K
- BL** Blue
- VE** Green
- RO** Red
- AM** "Wine" Amber



Code example:

CISO P33 CEILING LIGHT + H470mm + White + Light Beam 15° + 4000K = Code: P33.D115BN

# CISO P50 CEILING LIGHT

P50.

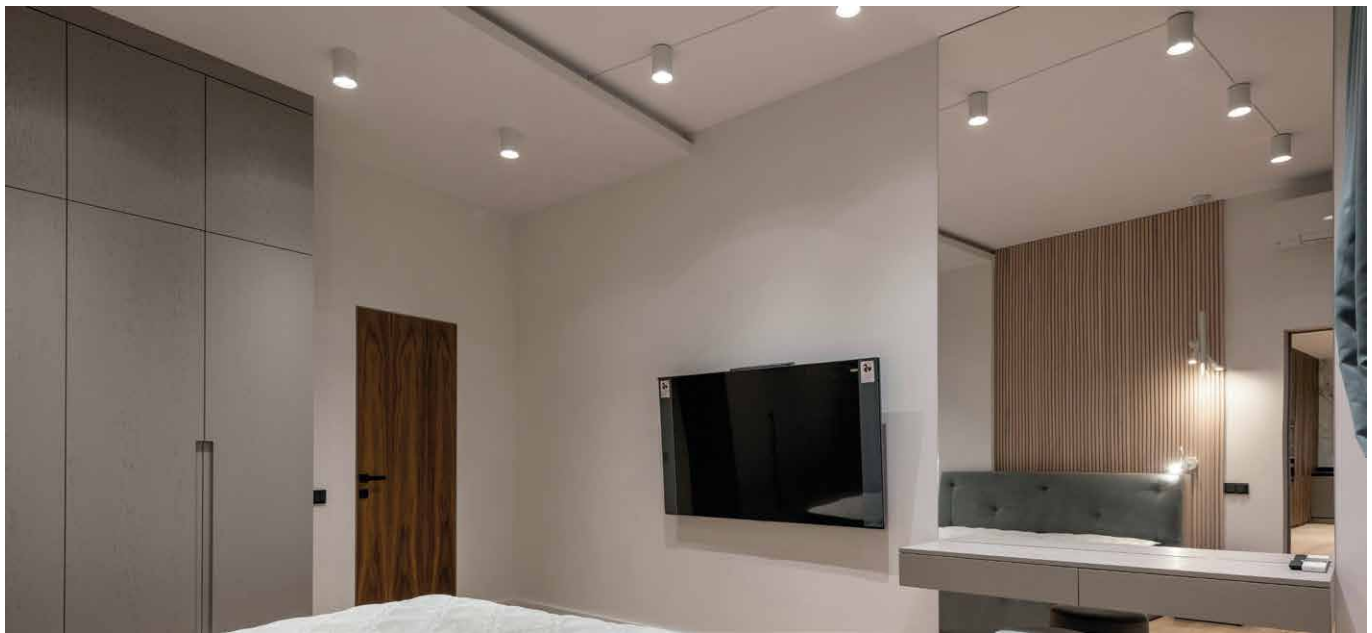

Ø50mm decorated aluminium cylinder ceiling light with power COB LEDs, suitable as accent or primary lighting for residential, restaurant or retail environments. Choice of flush-mounted secondary optics, can be installed indoors. Mounting with concealed base.

COB LED CRI>90

Power: 7W@200mA

Lumen: 916Lm@200mA

200mA constant current power supply

Power supply included and integrated

Dimming Accessories page 249



 **MADE IN ITALY**

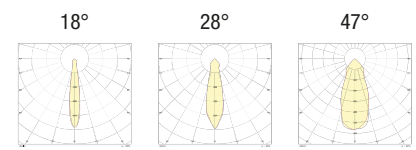
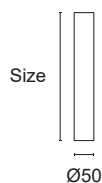

## BASIC CODES

**P50.**

## SIZE

**B** H 180mm\*

**C** H 290mm

**D** H 470mm

**E** H 760mm

\*(remote power supply)

## FINISHES

**1** White

**2** Matt black

**5** Gloss aluminium

**7** Brushed aluminium

**8** Gold leaf

**9** Bond Copper

## LIGHT BEAM

**18** 18°

**28** 28°

**47** 47°

## LED COLOUR

**BN** 4000K

**BC** 3000K

**CC** 2700K

Code example:

CISO P50 CEILING LIGHT + H470mm + White + Light Beam 18° + 4000K = Code: P50.D118BN

# CISO P80 CEILING LIGHT

P80.



Ø80mm decorated aluminium cylinder ceiling light with power COB LEDs, suitable as primary lighting for residential, commercial, restaurant or retail environments. Choice of flush-mounted secondary optics, can be installed indoors. Mounting with concealed base.

COB LED CRI>90

Power: 7W@200mA

Lumen: 916Lm@200mA

200mA constant current power supply

Power supply included and integrated

Dimming Accessories page 249



 **MADE IN ITALY**

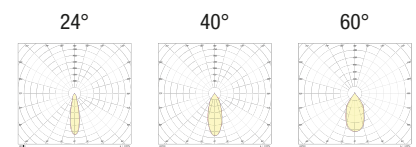
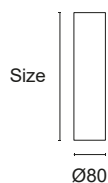

## BASIC CODES

**P80.**

## SIZE

**B** H 180mm\*

**C** H 290mm

**D** H 470mm

**E** H 760mm

\*(remote power supply)

## FINISHES

**1** White

**2** Matt black

**5** Gloss aluminium

**7** Brushed aluminium

**8** Gold leaf

**9** Bond Copper

## LIGHT BEAM

**24** 24°

**40** 40°

**60** 60°

## LED COLOUR

**BN** 4000K

**BC** 3000K

**CC** 2700K

Code example:

CISO P80 CEILING LIGHT + H470mm + White + Light Beam 40° + 4000K = Code: P80.D140BN

# CISO S31 PENDANT LIGHT

S31.



Ø32mm decorated aluminium cylinder suspended light with power LEDs, suitable as accent or highlight lighting for residential, restaurant or retail environments. Choice of flush-mounted secondary optics, can be installed indoors. Mounting with screw-in ceiling rose, cable 2000mm, choice of finish.

Power LED CRI>90  
Power: 2W@500mA  
Lumen: 216Lm@500mA  
500mA constant current power supply  
Power supply included and integrated

Installation accessories page 119  
Dimming Accessories page 249



 **MADE IN ITALY**

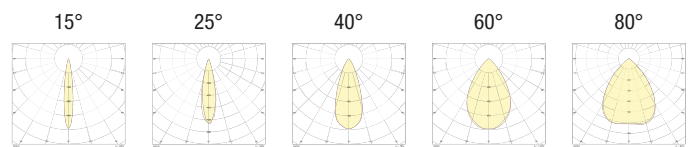
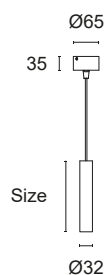

## BASIC CODES

**S31.**

## SIZE

- A** H 90mm
- B** H 180mm
- C** H 290mm
- D** H 470mm
- E** H 760mm

## FINISHES

- 1** White
- 2** Matt black
- 5** Gloss aluminium
- 7** Brushed aluminium
- 8** Gold leaf
- 9** Bond Copper

## LIGHT BEAM

- 15** 15°
- 25** 25°
- 40** 40°
- 60** 60°
- 80** 80°

## LED COLOUR

- BN** 4000K
- BC** 3000K
- CC** 2700K
- BL** Blue
- VE** Green
- RO** Red
- AM** "Wine" Amber



Approved by  
CIVIC

## CABLE

- T** Transparent
- B** White
- N** Black
- R** Red

## Code example:

CISO S31 SUSPENSION LIGHT + H470mm + White + Light Beam 15° + 4000K + Black Fabric Cable = Code: S31.D115BNN



# CISO S33 PENDANT LIGHT

S33.

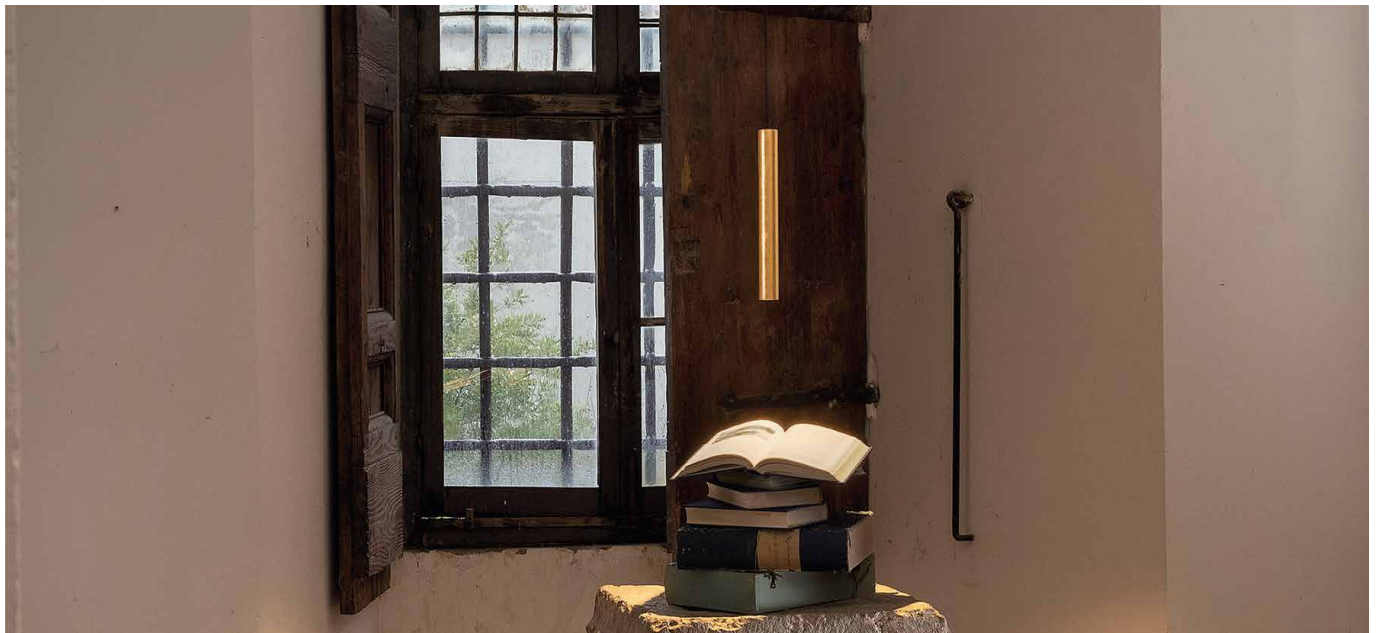

Ø32mm decorated aluminium cylinder suspended light with three power LEDs, suitable as accent or highlight lighting for residential, restaurant or retail environments. Choice of flush-mounted secondary optics, can be installed indoors. Mounting with screw-in ceiling rose, cable 2000mm, choice of finish.

Power LED CRI>90  
Power: 6W@500mA  
Lumen: 648Lm@500mA  
500mA constant current power supply  
Power supply included and integrated

Installation accessories page 119  
Dimming Accessories page 249

 **MADE IN ITALY**

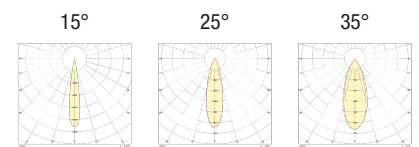
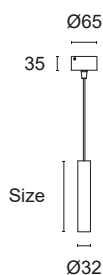

## BASIC CODES

**S33.**

## SIZE

- A** H 90mm
- B** H 180mm
- C** H 290mm
- D** H 470mm
- E** H 760mm

## FINISHES

- 1** White
- 2** Matt black
- 5** Gloss aluminium
- 7** Brushed aluminium
- 8** Gold leaf
- 9** Bond Copper

## LIGHT BEAM

- 15** 15°
- 25** 25°
- 35** 35°

## LED COLOUR

- BN** 4000K
- BC** 3000K
- CC** 2700K
- BL** Blue
- VE** Green
- RO** Red
- AM** "Wine" Amber

## CABLE

- T** Transparent
- B** White
- N** Black
- R** Red



Code example:

CISO S33 SUSPENSION LIGHT + H470mm + White + Light Beam 35° + 4000K + Black Fabric Cable = Code: S33.D135BNN

# CISO S50 PENDANT LIGHT

S50.



Ø50mm decorated aluminium cylinder suspension light, suitable as primary lighting for large residential, commercial, restaurant or retail environments. Choice of flush-mounted secondary optics, can be installed indoors. Mounting with screw-in ceiling rose, cable 2000mm, choice of finish.

COB LED CRI>90

Power: 7W@200mA

Lumen: 916Lm@200mA

200mA constant current power supply

Power supply included and integrated

Installation accessories page 119

Dimming Accessories page 249

 **MADE IN ITALY**

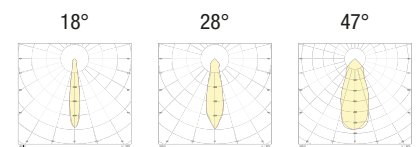
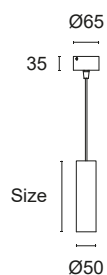

## BASIC CODES

**S50.**

## SIZE

- B** H 180mm
- C** H 290mm
- D** H 470mm
- E** H 760mm

## FINISHES

- 1** White
- 2** Matt black
- 5** Gloss aluminium
- 7** Brushed aluminium
- 8** Gold leaf
- 9** Bond Copper

## LIGHT BEAM

- 18** 18°
- 28** 28°
- 47** 47°

## LED COLOUR

- BN** 4000K
- BC** 3000K
- CC** 2700K

## CABLE

- T** Transparent
- B** White
- N** Black
- R** Red

Code example:

CISO S50 SUSPENSION LIGHT + H 470mm + White finish + Light Beam 28° + 4000K + Black Fabric Cable = Code: S50.D128BNN

# CISO S80 PENDANT LIGHT

S80.



Ø80mm decorated aluminium cylinder suspension light, suitable as primary lighting for large residential, commercial, restaurant or retail environments. Choice of flush-mounted secondary optics, can be installed indoors. Mounting with screw-in ceiling rose, cable 2000mm, choice of finish.

COB LED CRI>90

Power: 7W@200mA

Lumen: 916Lm@200mA

200mA constant current power supply

Power supply included and integrated

Installation accessories page 119

Dimming Accessories page 249

 **MADE IN ITALY**

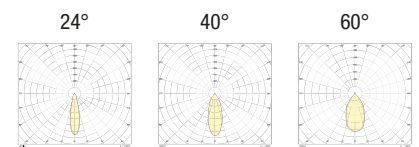
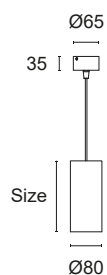

## BASIC CODES

**S80.**

## SIZE

- B** H 180mm
- C** H 290mm
- D** H 470mm
- E** H 760mm

## FINISHES

- 1** White
- 2** Matt black
- 5** Gloss aluminium
- 7** Brushed aluminium
- 8** Gold leaf
- 9** Bond Copper

## LIGHT BEAM

- 24** 24°
- 40** 40°
- 60** 60°

## LED COLOUR

- BN** 4000K
- BC** 3000K
- CC** 2700K

## CABLE

- T** Transparent
- B** White
- N** Black
- R** Red

Code example:

CISO S80 SUSPENSION LIGHT + H470mm + White + Light Beam 24° + 4000K + Black Fabric Cable = Code: S80.D124BNN

# CEILING ROSES FOR OTHER CISO COMPOSITIONS

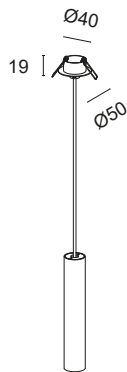

BASIC CODES

**S31.F1.**

FINISHES

- 1 White
- 2 Matt black
- 5 Gloss aluminium
- 7 Brushed aluminium
- 8 Gold leaf
- 9 Bond Copper

Ø50 mm decorated aluminium ceiling rose for fixing CISO S31, S33, S50 and S80 suspension lights onto plasterboard. Flush-mounted with springs.

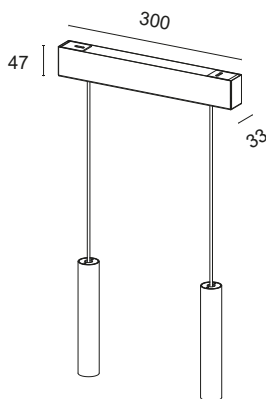

BASIC CODES

**RM0300.**

FINISHES

- 1 White
- 2 Matt black
- 7 Brushed aluminium
- 8 Gold leaf
- 9 Bond Copper

300 mm decorated metal ceiling rose for CISO S31, S33, S50 and S80 suspension compositions. Contains the single-cylinder power supply. Mounting with bracket with concealed screws and magnetic ceiling rose. N.B. Drilling and number of suspended lights to be defined when ordering.

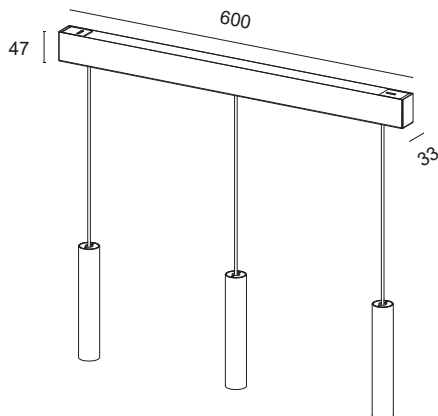

BASIC CODES

**RM0600.**

FINISHES

- 1 White
- 2 Matt black
- 7 Brushed aluminium
- 8 Gold leaf
- 9 Bond Copper

600 mm decorated metal ceiling rose for CISO S31, S33, S50 and S80 suspension compositions. Contains the single-cylinder power supply. Mounting with bracket with concealed screws and magnetic ceiling rose. N.B. Drilling and number of suspended lights to be defined when ordering.

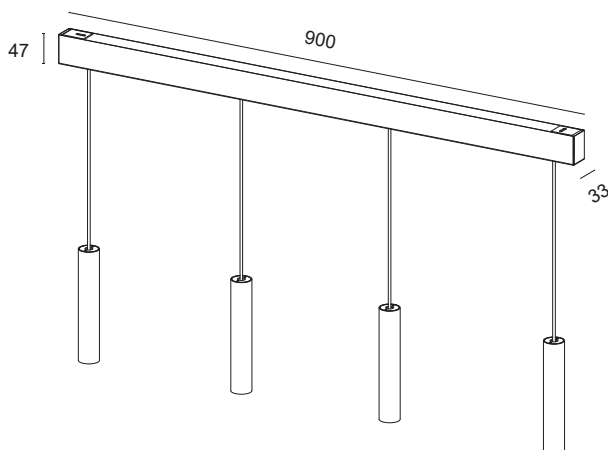

BASIC CODES

**RM0900.**

FINISHES

- 1 White
- 2 Matt black
- 7 Brushed aluminium
- 8 Gold leaf
- 9 Bond Copper

900 mm decorated metal ceiling rose for CISO S31, S33, S50 and S80 suspension compositions. Contains the single-cylinder power supply. Mounting with bracket with concealed screws and magnetic ceiling rose. N.B. Drilling and number of suspended lights to be defined when ordering.

Code example:  
300mm Ceiling Rose + White = Code: RM0300.1





## LINEAR FLUSH-MOUNTED SYSTEM

EPTA	122
SIGMA	124
REFLEX	126
IOTA	128
RASO	130
RHO 1	132
YPSILON 1	134
DELTA 3	136
TAU	138
MILKY	140

# EPTA

## E1.

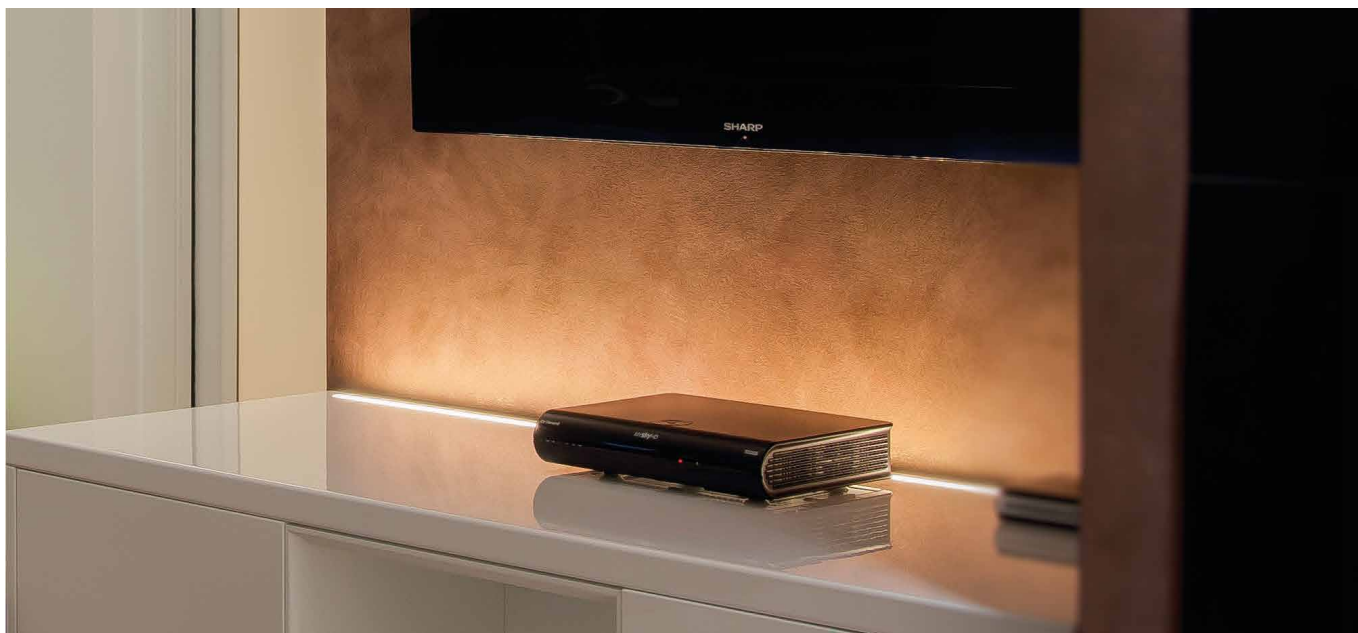

Decorated anodised aluminium lamp complete with brushed or transparent diffuser and high-brightness LED source with a high Lumen/Watt ratio. Wide availability of accessories that can be integrated into the profile. Suitable for accent and service lighting, suitable for furniture, residential, retail and general lighting. Flush-mounted

Constant 24Vdc voltage supply  
Parallel connection, 50 cm cable

Constant voltage power supplies page 237

Dimming Accessories page 249

 **MADE IN ITALY**

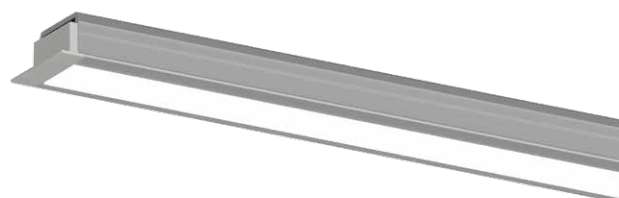

Max. milling cut 18mm

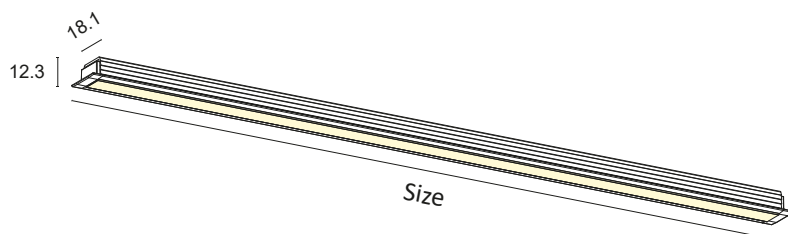
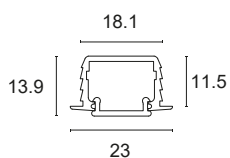

BASIC CODES

**E1.**

FINISHES

- 1** White
  - 2** Matt black
  - 7** Brushed aluminium
- \*Other finishes on request.

SIDE SUPPORTS

- 1** White
- 2** Matt black
- 5** Grey
- 7** Brushed aluminium

SIDE SUPPORTS + TOUCH

- 1T** White
- 2T** Matt black
- 5T** Grey
- 7T** Brushed aluminium

SIDE SUPPORTS + SENSOR

- 1S** White
- 2S** Matt black
- 5S** Grey
- 7S** Brushed aluminium

SIDE SUPPORTS + ON/OFF

- 1I** White
- 2I** Matt black
- 5I** Grey
- 7I** Brushed aluminium

SIZE

- A** 300mm
- B** 450mm
- C** 500mm
- D** 600mm
- E** 700mm
- F** 800mm
- G** 900mm
- H** 1000mm
- I** 1200mm
- J** 1300mm
- K** 1400mm
- L** 1500mm
- M** 1800mm
- N** 2000mm
- O** 2300mm
- P** 2500mm
- Q** 2800mm
- R** 3000mm

LED COLOUR

- BN** 4000K
  - BC** 3000K
  - CC** 2700K
- \*Strip also available coloured, Dynamic White, RGB and RGBW.

POWER

<b>D</b>	10W/m	1400Lm/m	98LED/m	S2835	CRI>85	
<b>D+</b>	10W/m	1400Lm/m	112LED/m	S2835	CRI>90	
<b>E</b>	16.8W/m	2000Lm/m	140LED/m	S2835	CRI>85	
<b>E+</b>	16.8W/m	2000Lm/m	140LED/m	S2835	CRI>90	
<b>F</b>	20.2W/m	2500Lm/m	168LED/m	S2835	CRI>85	
<b>F+</b>	20.2W/m	2500Lm/m	168LED/m	S2835	CRI>90	
<b>G</b>	25W/m	3500Lm/m	160LED/m	S2835	CRI>80	
<b>L+</b>	28W/m	3500Lm/m	160LED/m	S2835	CRI>90	
<b>G2+</b>	15W/m	1550Lm/m	COB LED		CRI>90	

\*Energy class referring to light source

DIFFUSER

- S** BRUSHED
- T** TRANSPARENT

Code example:

EPTA + White + Side supports white + 900mm + 3000K + 10W/m CRI>85 + Brushed diffuser = Code: E1.11GBGCD



# SIGMA

## S1.



Decorated anodised aluminium lamp complete with brushed or transparent diffuser and high-brightness LED source with a high Lumen/Watt ratio. Suitable for accent and service lighting, suitable for furniture, residential, retail and general lighting. Flush-mounted

Constant 24Vdc voltage supply  
Parallel connection, 50 cm cable

Constant voltage power supplies page 237

Dimming Accessories page 249

 **MADE IN ITALY**



Max. milling cut 25mm

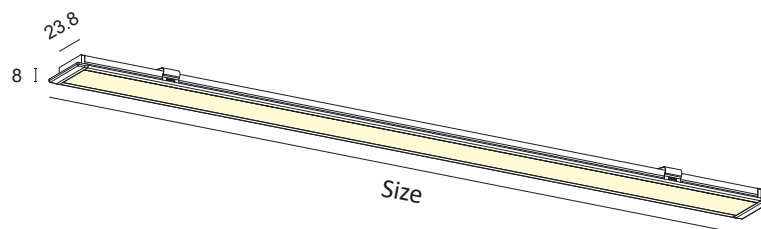
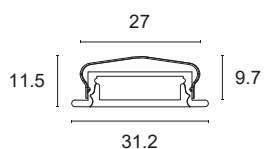

BASIC CODES

**S1.**

FINISHES

- 1** White
  - 2** Matt black
  - 7** Brushed aluminium
- \*Other finishes on request.

SIDE SUPPORTS

- 1** White
- 2** Matt black
- 5** Grey
- 7** Brushed aluminium

SIDE SUPPORTS + TOUCH

- 1T** White
- 2T** Matt black
- 5T** Grey
- 7T** Brushed aluminium

SIZE

- A** 300mm
- B** 450mm
- C** 500mm
- D** 600mm
- E** 700mm
- F** 800mm
- G** 900mm
- H** 1000mm
- I** 1200mm
- J** 1300mm
- K** 1400mm
- L** 1500mm
- M** 1800mm
- N** 2000mm
- O** 2300mm
- P** 2500mm
- Q** 2800mm
- R** 3000mm

LED COLOUR

- BN** 4000K
  - BC** 3000K
  - CC** 2700K
- \*Strip also available coloured, Dynamic White, RGB and RGBW.

POWER

- |            |         |          |          |       |        |  |
|------------|---------|----------|----------|-------|--------|--|
| <b>E</b>   | 16.8W/m | 2000Lm/m | 140LED/m | S2835 | CRI>85 |  |
| <b>E+</b>  | 16.8W/m | 2000Lm/m | 140LED/m | S2835 | CRI>90 |  |
| <b>F</b>   | 20.2W/m | 2500Lm/m | 168LED/m | S2835 | CRI>85 |  |
| <b>F+</b>  | 20.2W/m | 2500Lm/m | 168LED/m | S2835 | CRI>90 |  |
| <b>G</b>   | 25W/m   | 3500Lm/m | 160LED/m | S2835 | CRI>80 |  |
| <b>L+</b>  | 28W/m   | 3500Lm/m | 160LED/m | S2835 | CRI>90 |  |
| <b>H</b>   | 30W/m   | 4500Lm/m | 240LED/m | S2835 | CRI>80 |  |
| <b>C1+</b> | 10W/m   | 1050Lm/m | COB LED  |       | CRI>90 |  |
| <b>C2+</b> | 15W/m   | 1550Lm/m | COB LED  |       | CRI>90 |  |

\*Energy class referring to light source

DIFFUSER

- S** BRUSHED

Code example:

EPTA + White + Side supports white + 1000mm + 3000K + 25W/m CRI>80 + Brushed diffuser = Code: S1.11HBCGS

# REFLEX

X1.



Decorated anodised aluminium lamp complete with brushed diffuser and indirect emission, high-brightness LED source with a high Lumen/Watt ratio. Suitable for accent and service lighting, suitable for furnishing, residential, retail and general lighting. Flush-mounted

Constant 24Vdc voltage supply  
Parallel connection, 50 cm cable

Constant voltage power supplies page 237  
Dimming Accessories page 249

 **MADE IN ITALY**



Max. milling cut 23mm

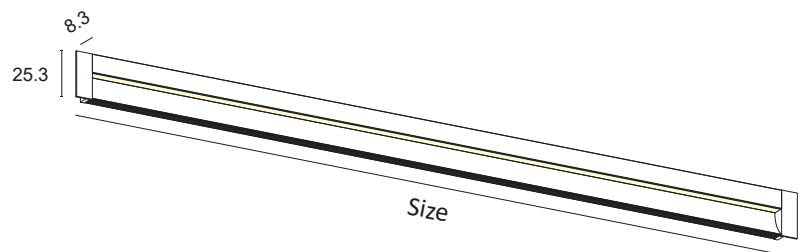
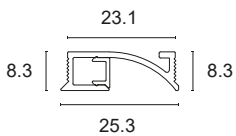

**BASIC CODES**

**X1.**

**FINISHES**

- 1** White
  - 2** Matt black
  - 7** Brushed aluminium
- \*Other finishes on request.

**SIDE SUPPORTS**

- 1** White
- 2** Matt black
- 7** Brushed aluminium

**SIZE**

- A** 300mm
- B** 450mm
- C** 500mm
- D** 600mm
- E** 700mm
- F** 800mm
- G** 900mm
- H** 1000mm
- I** 1200mm
- J** 1300mm
- K** 1400mm
- L** 1500mm
- M** 1800mm
- N** 2000mm
- O** 2300mm
- P** 2500mm
- Q** 2800mm
- R** 3000mm

**LED COLOUR**

- BN** 4000K
- BC** 3000K
- CC** 2700K

**POWER**

- N+** 9.6W/m    800Lm/m 120LED/m S2216 CRI>90 
- O+** 12W/m    1000Lm/m 300LED/m S2216 CRI>90 
- P+** 14.4W/m    1100Lm/m 180LED/m S2216 CRI>90 

\*Energy class referring to light source

**DIFFUSER**

- S** BRUSHED

**Code example:**

REFLEX + White + Side supports white + 1000mm + 3000K + 12W/m CRI>90 + Brushed diffuser = Code: X1.11HBCO+S



# IOTA

I1.



Decorated anodised aluminium lamp complete with flush-fitted brushed diffuser and high-brightness LED source with a high Lumen/Watt ratio. Suitable for accent and primary residential, retail and general lighting. Flush-mounted

Constant 24Vdc voltage supply  
Parallel connection, 50 cm cable

Constant voltage power supplies page 237  
Dimming Accessories page 249

 **MADE IN ITALY**

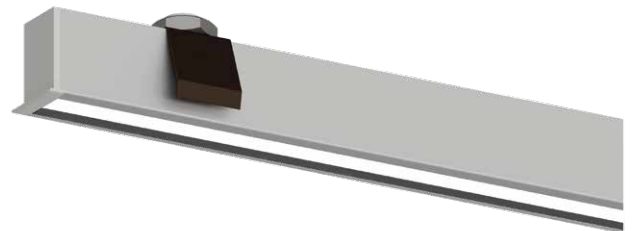

Max. milling cut 15mm

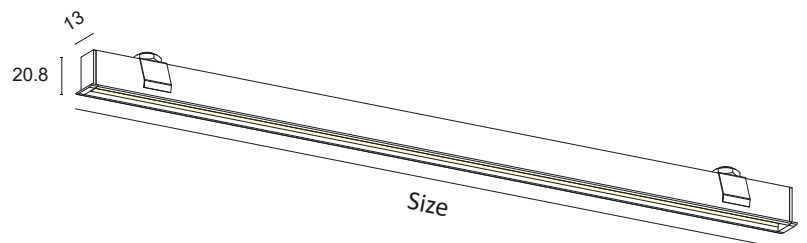
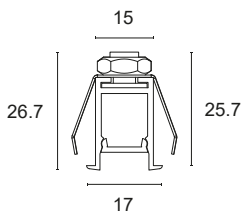

BASIC CODES

**I1.**

FINISHES

- 1** White
  - 2** Matt black
  - 7** Brushed aluminium
- \*Other finishes on request.

SIDE SUPPORTS

- 1** White
- 2** Matt black
- 5** Grey
- 7** Brushed aluminium

SIZE

- A** 300mm
- B** 450mm
- C** 500mm
- D** 600mm
- E** 700mm
- F** 800mm
- G** 900mm
- H** 1000mm
- I** 1200mm
- J** 1300mm
- K** 1400mm
- L** 1500mm
- M** 1800mm
- N** 2000mm
- O** 2300mm
- P** 2500mm
- Q** 2800mm
- R** 3000mm

LED COLOUR

- BN** 4000K
  - BC** 3000K
  - CC** 2700K
- \*Strip also available coloured, Dynamic White, RGB.

POWER

<b>D</b>	10W/m	1400Lm/m	98LED/m	S2835	CRI>85	
<b>D+</b>	10W/m	1400Lm/m	112LED/m	S2835	CRI>90	
<b>E</b>	16.8W/m	2000Lm/m	140LED/m	S2835	CRI>85	
<b>E+</b>	16.8W/m	2000Lm/m	140LED/m	S2835	CRI>90	
<b>F</b>	20.2W/m	2500Lm/m	168LED/m	S2835	CRI>85	
<b>F+</b>	20.2W/m	2500Lm/m	168LED/m	S2835	CRI>90	
<b>G</b>	25W/m	3500Lm/m	160LED/m	S2835	CRI>80	
<b>L+</b>	28W/m	3500Lm/m	160LED/m	S2835	CRI>90	
<b>C1+</b>	10W/m	1050Lm/m	COB LED		CRI>90	

\*Energy class referring to light source

DIFFUSER

- S** BRUSHED

Code example:

IOTA + White + Side supports white + 900mm + 3000K + 10W/m CRI>85 + Brushed diffuser = Code: I1.11GBCDS

# RASO

## RS.



Decorated anodised aluminium lamp complete with brushed or microprismatic diffuser and high-brightness LED source with a high Lumen/Watt ratio. Suitable for primary residential, retail, large-space and general lighting. Flush-mounted installation onto plasterboard, also supplied with non-returnable cover for plastering.

Constant 24Vdc voltage supply  
Parallel connection, 50 cm cable

Constant voltage power supplies page 237

Dimming Accessories page 249

 **MADE IN ITALY**

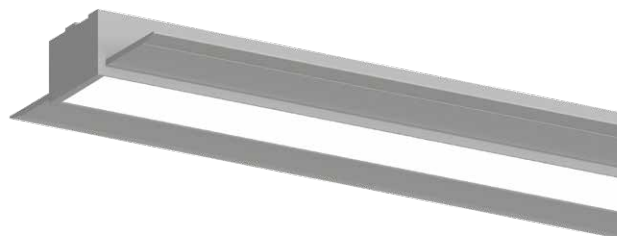

Max. milling cut 22mm

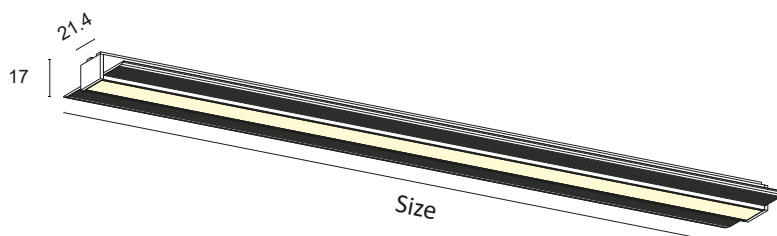
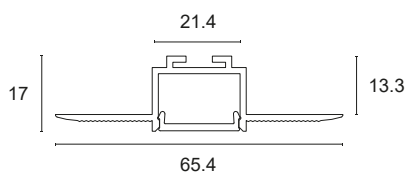

**BASIC CODES**

**RS.**

**FINISHES**

- 1** White
  - 2** Matt black
  - 7** Brushed aluminium
- \*Other finishes on request.

**SIDE SUPPORTS**

- 1** White
- 2** Matt black
- 7** Brushed aluminium

**SIZE**

- A** 300mm
- B** 450mm
- C** 500mm
- D** 600mm
- E** 700mm
- F** 800mm
- G** 900mm
- H** 1000mm
- I** 1200mm
- J** 1300mm
- K** 1400mm
- L** 1500mm
- M** 1800mm
- N** 2000mm
- O** 2300mm
- P** 2500mm
- Q** 2800mm
- R** 3000mm

**LED COLOUR**

- BN** 4000K
  - BC** 3000K
  - CC** 2700K
- \*Strip also available coloured, Dynamic White, RGB and RGBW.

**POWER**

<b>E</b>	16.8W/m	2000Lm/m	140LED/m	S2835	CRI>85	
<b>E+</b>	16.8W/m	2000Lm/m	140LED/m	S2835	CRI>90	
<b>F</b>	20.2W/m	2500Lm/m	168LED/m	S2835	CRI>85	
<b>F+</b>	20.2W/m	2500Lm/m	168LED/m	S2835	CRI>90	
<b>G</b>	25W/m	3500Lm/m	160LED/m	S2835	CRI>80	
<b>L+</b>	28W/m	3500Lm/m	160LED/m	S2835	CRI>90	
<b>H</b>	30W/m	4500Lm/m	240LED/m	S2835	CRI>80	

\*Energy class referring to light source

**DIFFUSER**

- M** MICROPRISMATIC
- S** BRUSHED

**Code example:**

RASO + White + Side supports white + 1000mm + 3000K + 25W/m CRI>80 + Brushed diffuser = Code: RS.11HBCGS



# RHO 1

R1.

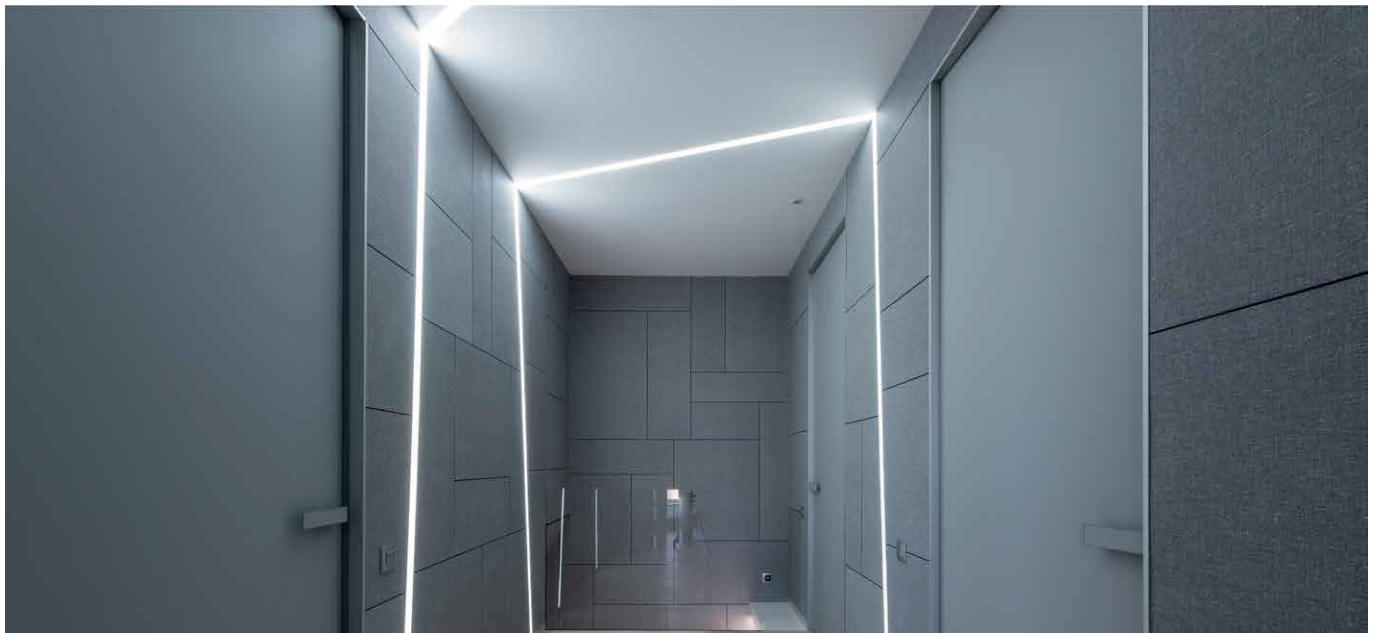

Decorated anodised aluminium lamp complete with brushed or microprismatic diffuser and high-brightness LED source with a high Lumen/Watt ratio. Suitable for primary residential, retail, large-space and general lighting. Flush-mounted installation onto plasterboard or brick, also supplied with non-returnable cover for plastering.

Constant 24Vdc voltage supply  
Parallel connection, 50 cm cable

Constant voltage power supplies page 237  
Dimming Accessories page 249

 **MADE IN ITALY**

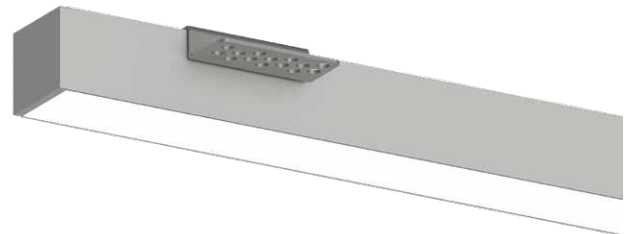

Max. milling cut 23.5mm

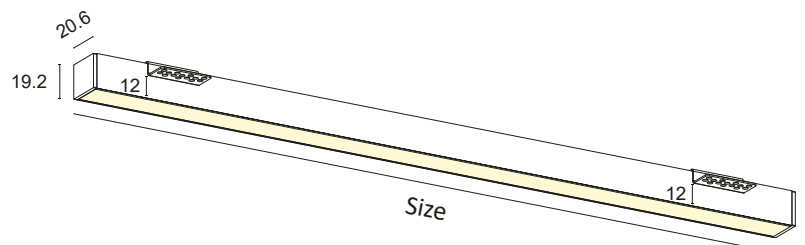
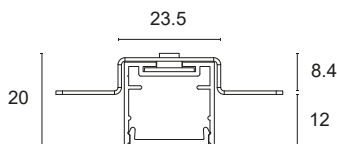

BASIC CODES

**R1.**

FINISHES

- 1** White
  - 2** Matt black
  - 7** Brushed aluminium
- \*Other finishes on request.

SIDE SUPPORTS

- 1** White
- 2** Matt black
- 7** Brushed aluminium

SIZE

- C** 500mm
- D** 600mm
- E** 700mm
- F** 800mm
- G** 900mm
- H** 1000mm
- I** 1200mm
- J** 1300mm
- K** 1400mm
- L** 1500mm
- M** 1800mm
- N** 2000mm
- O** 2300mm
- P** 2500mm
- Q** 2800mm
- R** 3000mm

LED COLOUR

- BN** 4000K
  - BC** 3000K
  - CC** 2700K
- \*Strip also available coloured, Dynamic White, RGB and RGBW.

POWER

- |           |         |          |          |       |        |   |
|-----------|---------|----------|----------|-------|--------|---|
| <b>E</b>  | 16.8W/m | 2000Lm/m | 140LED/m | S2835 | CRI>85 |    |
| <b>E+</b> | 16.8W/m | 2000Lm/m | 140LED/m | S2835 | CRI>90 |    |
| <b>F</b>  | 20.2W/m | 2500Lm/m | 168LED/m | S2835 | CRI>85 |  |
| <b>F+</b> | 20.2W/m | 2500Lm/m | 168LED/m | S2835 | CRI>90 |  |
| <b>G</b>  | 25W/m   | 3500Lm/m | 160LED/m | S2835 | CRI>80 |  |
| <b>L+</b> | 28W/m   | 3500Lm/m | 160LED/m | S2835 | CRI>90 |  |
| <b>H</b>  | 30W/m   | 4500Lm/m | 240LED/m | S2835 | CRI>80 |  |

\*Energy class referring to light source

DIFFUSER

- M** MICROPRISMATIC
- S** BRUSHED

Code example:

RHO 1 + White + Side supports white + 1000mm + 3000K + 25W/m CRI>80 + Brushed diffuser = Code: R1.11HBCGS

# YPSILON 1

Y1.



Decorated anodised aluminium lamp complete with brushed or microprismatic diffuser and high-brightness LED source with a high Lumen/Watt ratio. Suitable for primary residential, retail, large-space and general lighting. The interlocking profile mechanism allows for easy maintenance. Flush-mounted installation onto plasterboard or brick, also supplied with non-returnable cover for plastering.

Constant 24Vdc voltage supply  
Parallel connection, 50 cm cable

Constant voltage power supplies page 237  
Dimming Accessories page 249

 **MADE IN ITALY**

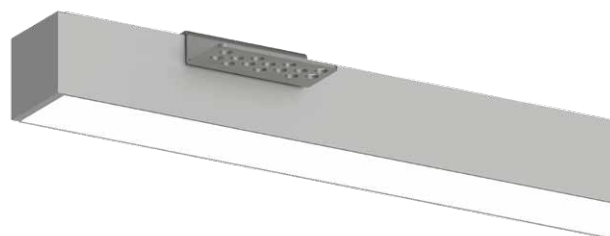

Max. milling cut 23.5mm

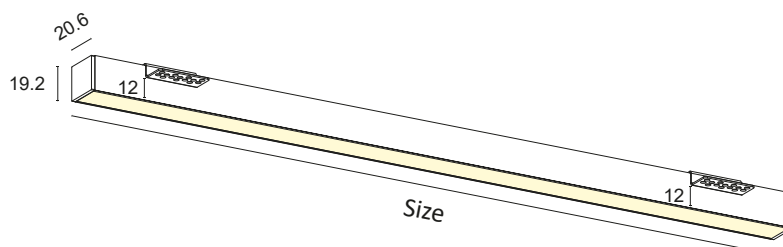
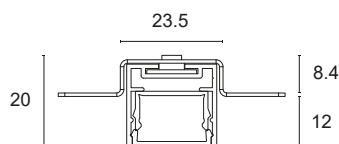

BASIC CODES

**Y1.**

FINISHES

- 1** White
  - 2** Matt black
  - 7** Brushed aluminium
- \*Other finishes on request.

SIDE SUPPORTS

- 1** White
- 2** Matt black
- 7** Brushed aluminium

SIZE

- C** 500mm
- D** 600mm
- E** 700mm
- F** 800mm
- G** 900mm
- H** 1000mm
- I** 1200mm
- J** 1300mm
- K** 1400mm
- L** 1500mm
- M** 1800mm
- N** 2000mm
- O** 2300mm
- P** 2500mm
- Q** 2800mm
- R** 3000mm

LED COLOUR

- BN** 4000K
  - BC** 3000K
  - CC** 2700K
- \*Strip also available coloured, Dynamic White, RGB and RGBW.

POWER

- |           |         |          |          |       |        |   |
|-----------|---------|----------|----------|-------|--------|---|
| <b>E</b>  | 16.8W/m | 2000Lm/m | 140LED/m | S2835 | CRI>85 |    |
| <b>E+</b> | 16.8W/m | 2000Lm/m | 140LED/m | S2835 | CRI>90 |    |
| <b>F</b>  | 20.2W/m | 2500Lm/m | 168LED/m | S2835 | CRI>85 |  |
| <b>F+</b> | 20.2W/m | 2500Lm/m | 168LED/m | S2835 | CRI>90 |  |
| <b>G</b>  | 25W/m   | 3500Lm/m | 160LED/m | S2835 | CRI>80 |  |
| <b>L+</b> | 28W/m   | 3500Lm/m | 160LED/m | S2835 | CRI>90 |  |

\*Energy class referring to light source

DIFFUSER

- M** MICROPRISMATIC
- S** BRUSHED

Code example:

YPSILON 1 + White + Side supports white + 1000mm + 3000K + 25W/m CRI>80 + Brushed diffuser = Code: Y1.11HBCGS



# DELTA 3

D3.



Decorated anodised aluminium lamp complete with brushed or microprismatic diffuser and high-brightness LED source with a high Lumen/Watt ratio. Suitable for primary lighting for residential, retail, large-space and general lighting. Flush-mounted

Constant 24Vdc voltage supply

Parallel connection, 50 cm cable

Constant voltage power supplies page 237

Dimming Accessories page 249

 **MADE IN ITALY**

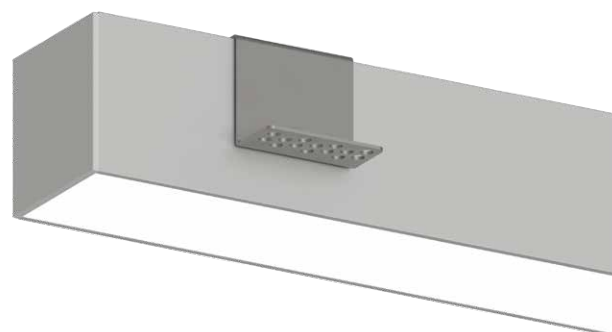

Max. milling cut 39.8mm

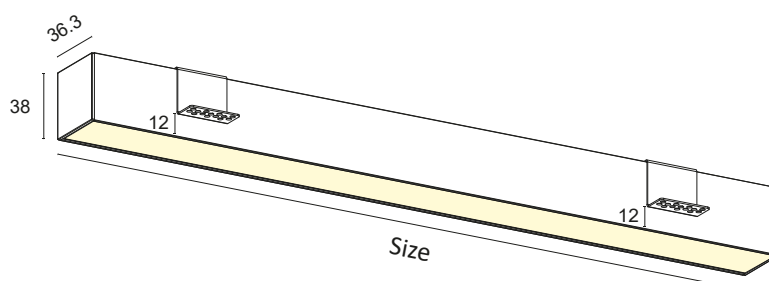
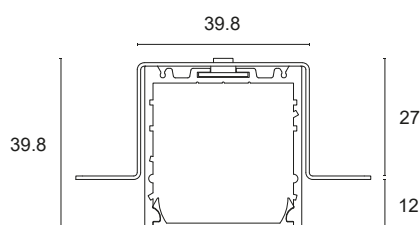

**BASIC CODES**

**D3.**

**FINISHES**

- 1** White
  - 2** Matt black
  - 7** Brushed aluminium
- \*Other finishes on request.

**SIDE SUPPORTS**

- 1** White
- 2** Matt black
- 5** Grey
- 7** Brushed aluminium

**SIZE**

- C** 500mm
- D** 600mm
- E** 700mm
- F** 800mm
- G** 900mm
- H** 1000mm
- I** 1200mm
- J** 1300mm
- K** 1400mm
- L** 1500mm
- M** 1800mm
- N** 2000mm
- O** 2300mm
- P** 2500mm
- Q** 2800mm
- R** 3000mm

**LED COLOUR**

- BN** 4000K
  - BC** 3000K
  - CC** 2700K
- \*Strip also available coloured, Dynamic White, RGB and RGBW.

**POWER**

<b>F</b>	20.2W/m	2500Lm/m	168LED/m	S2835	CRI>85	
<b>F+</b>	20.2W/m	2500Lm/m	168LED/m	S2835	CRI>90	
<b>G</b>	25W/m	3500Lm/m	160LED/m	S2835	CRI>80	
<b>L+</b>	28W/m	3500Lm/m	160LED/m	S2835	CRI>90	
<b>H</b>	30W/m	4500Lm/m	240LED/m	S2835	CRI>80	
<b>M+</b>	40W/m	5000Lm/m	480LED/m	S2835	CRI>90	

\*Energy class referring to light source

**DIFFUSER**

- M** MICROPRISMATIC
- S** BRUSHED

**Code example:**

DELTA 3 + White + Side supports white + 900mm + 3000K + 20.2W/m CRI>85 + Brushed diffuser = Code: D3.11GBCFS

## COMPLEMENTARY SYSTEMS

**EXAMPLE OF DELTA FLUSH MOUNTED AND REM PROJECTOR**

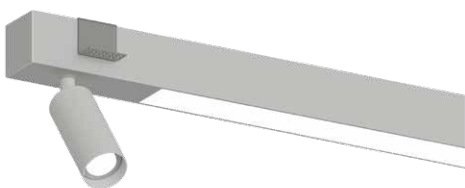

\*Details on p. 276

**EXAMPLE OF DELTA FLUSH MOUNTED AND DARK MODULE**

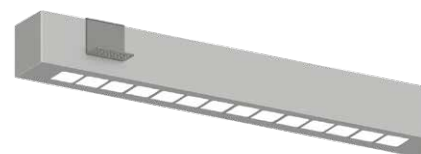

\*Details on p. 276

**EXAMPLE OF DELTA FLUSH MOUNTED, REM AND DARK MODULE**

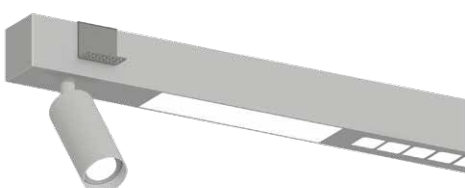

\*Details on p. 276

# TAU

T1.



Decorated anodised aluminium lamp complete with brushed or microprismatic diffuser and high-brightness LED source with a high Lumen/Watt ratio. Suitable for primary residential, retail, large-space and general lighting. Flush-mounted

Constant 24Vdc voltage supply  
Parallel connection, 50 cm cable

Constant voltage power supplies page 237  
Dimming Accessories page 249

 **MADE IN ITALY**

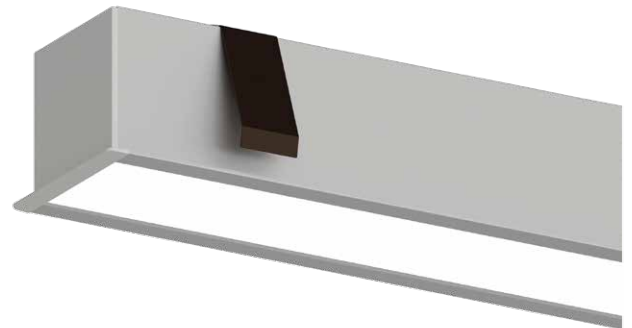

Max. milling cut 38.3mm

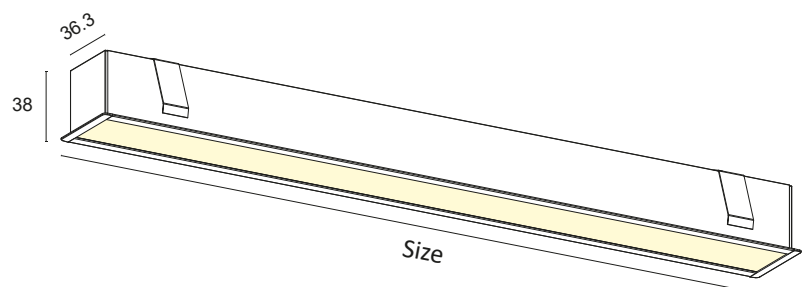
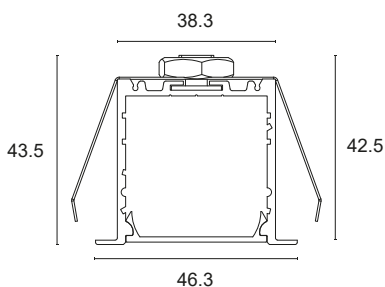

BASIC CODES

**T1.**

FINISHES

- 1** White
  - 2** Matt black
  - 7** Brushed aluminium
- \*Other finishes on request.

SIDE SUPPORTS

- 1** White
- 2** Matt black
- 5** Grey
- 7** Brushed aluminium

SIZE

- C** 500mm
- D** 600mm
- E** 700mm
- F** 800mm
- G** 900mm
- H** 1000mm
- I** 1200mm
- J** 1300mm
- K** 1400mm
- L** 1500mm
- M** 1800mm
- N** 2000mm
- O** 2300mm
- P** 2500mm
- Q** 2800mm
- R** 3000mm

LED COLOUR

- BN** 4000K
  - BC** 3000K
  - CC** 2700K
- \*Strip also available coloured, Dynamic White, RGB and RGBW.

POWER

- |           |         |          |          |       |        |   |
|-----------|---------|----------|----------|-------|--------|---|
| <b>F</b>  | 20.2W/m | 2500Lm/m | 168LED/m | S2835 | CRI>85 |    |
| <b>F+</b> | 20.2W/m | 2500Lm/m | 168LED/m | S2835 | CRI>90 |    |
| <b>G</b>  | 25W/m   | 3500Lm/m | 160LED/m | S2835 | CRI>80 |  |
| <b>L+</b> | 28W/m   | 3500Lm/m | 160LED/m | S2835 | CRI>90 |  |
| <b>H</b>  | 30W/m   | 4500Lm/m | 240LED/m | S2835 | CRI>80 |  |
| <b>M+</b> | 40W/m   | 5000Lm/m | 480LED/m | S2835 | CRI>90 |  |

\*Energy class referring to light source

DIFFUSER

- M** MICROPRISMATIC
- S** BRUSHED

Code example:

TAU + White + Side supports white + 1000mm + 3000K + 25W/m CRI>80 + Brushed diffuser = Code: T1.11HBCGS

# MILKY MK.



Polycarbonate lamp complete with aluminium heat sink and high-brightness LED source with a high Lumen/Watt ratio. Suitable for accent lighting of furnishing, retail and general lighting.

Flush-mounted

Constant 24Vdc voltage supply  
Parallel connection, 50 cm cable

Constant voltage power supplies page 237

Dimming Accessories page 249

 **MADE IN ITALY**

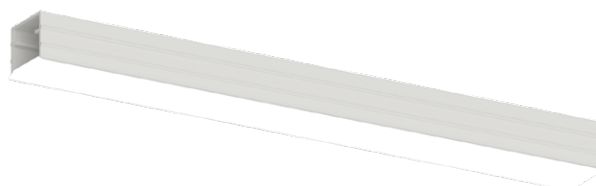

Max. milling cut 8mm

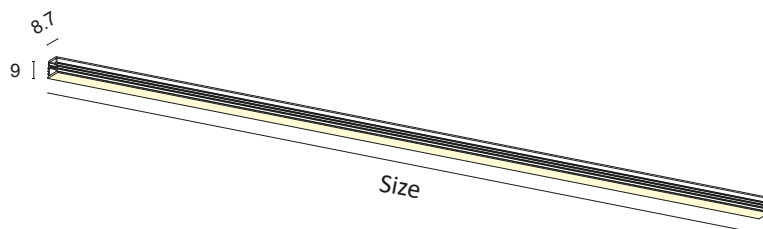
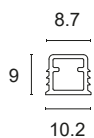



BASIC CODES

**MK.**

SIZE

- A** 300mm
- B** 450mm
- C** 500mm
- D** 600mm
- E** 700mm
- F** 800mm
- G** 900mm
- H** 1000mm
- I** 1200mm
- J** 1300mm
- K** 1400mm
- L** 1500mm
- M** 1800mm
- N** 2000mm
- O** 2300mm
- P** 2500mm
- Q** 2800mm
- R** 3000mm

LED COLOUR

- BN** 4000K
- BC** 3000K
- CC** 2700K

POWER

**0+** 12W/m 1000Lm/m 300LED/m S2216 CRI>90



\*Energy class referring to light source

**Code example:**

MILKY + 1000mm + 3000K + 12W/m CRI>90 = Codice: **MK.HBCO+**



rom  
SOCIETE  
GENERALE  
Paris

BIEN  
13

## CEILING-MOUNTED OR FLUSH-MOUNTED LINEAR SYSTEMS

MINI	144
JEY 1	146
JEY 2	148
ZETA 1	150
ZETA 2	152
RHO 3	154
VELA 1	156
VELA 2	158
GAMMA	160
VEGA	162
BETA	164
DELTA 1	166
KAPPA 3	168
QU	170
H1	172
H2	174
H3	176
C1	178
C2	180

# MINI M1.

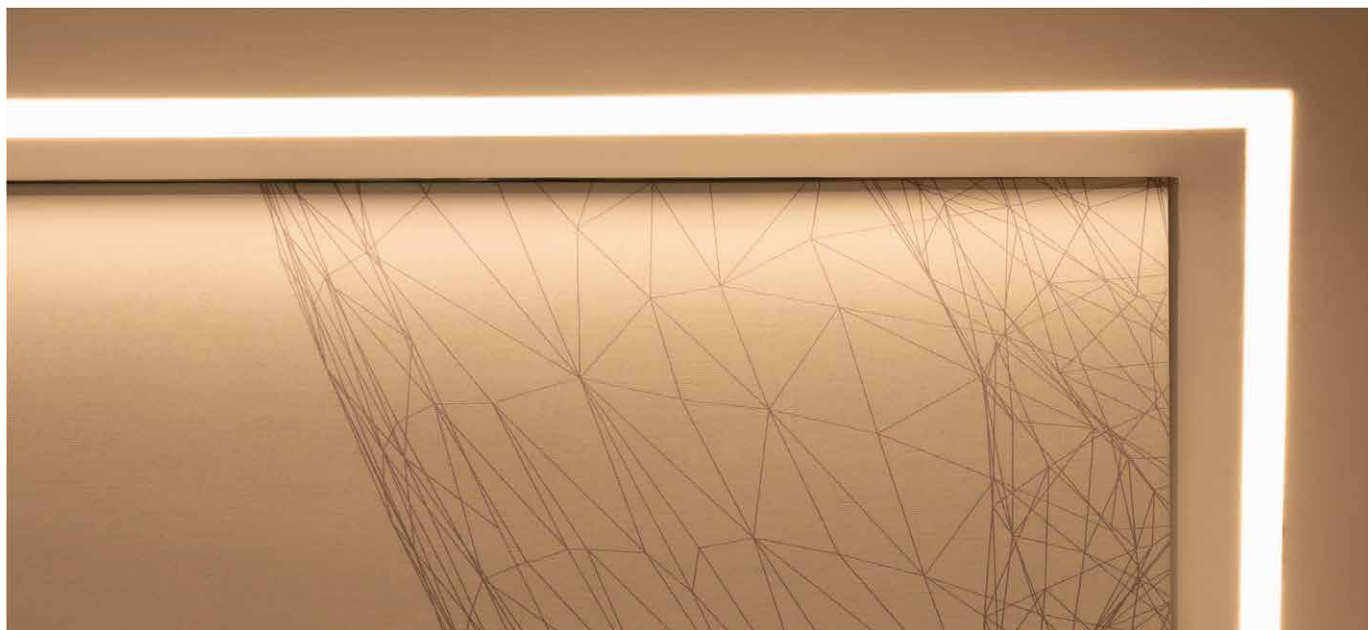

Decorated anodised aluminium lamp complete with press-fit brushed diffuser, side supports and LED source with a high Lumen/Watt ratio. Suitable for furnishing lighting and general lighting. Mounting with screw clips.

Constant 24Vdc voltage supply  
Parallel connection, 50 cm cable

Constant voltage power supplies page 237  
Dimming Accessories page 249

 **MADE IN ITALY**

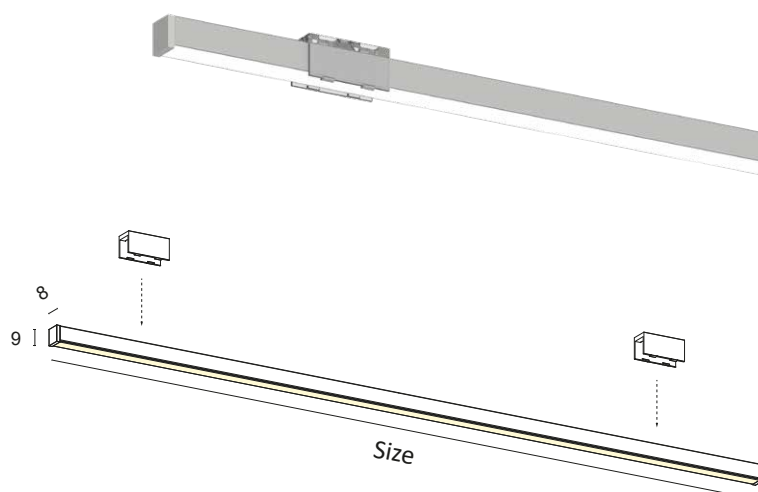
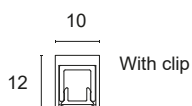
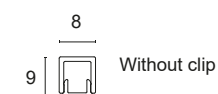

BASIC CODES

**M1.**

FINISHES

- 1** White
  - 2** Matt black
  - 7** Brushed aluminium
- \*Other finishes on request.

SIDE SUPPORTS

- 1** White
- 2** Matt black
- 5** Grey

SIZE

- A** 300mm
- B** 450mm
- C** 500mm
- D** 600mm
- E** 700mm
- F** 800mm
- G** 900mm
- H** 1000mm
- I** 1200mm
- J** 1300mm
- K** 1400mm
- L** 1500mm
- M** 1800mm
- N** 2000mm
- O** 2300mm
- P** 2500mm
- Q** 2800mm
- R** 3000mm

LED COLOUR

- BN** 4000K
- BC** 3000K
- CC** 2700K

POWER

- N+** 9.6W/m    800Lm/m 120LED/m S2216 CRI>90 
- O+** 12W/m    1000Lm/m 300LED/m S2216 CRI>90 
- P+** 14.4W/m    1100Lm/m 180LED/m S2216 CRI>90 

\*Energy class referring to light source

DIFFUSER

- S** BRUSHED

Code example:

MINI + White + Side supports white + 1000mm + 3000K + 12W/m CRI>90 + Brushed diffuser = Code: M1.11HBC0+S



# JEY 1

J1.



Decorated anodised aluminium lamp complete with press-fit brushed diffuser, side supports and LED source with a high Lumen/Watt ratio. Suitable for furnishing lighting and general lighting. Mounting with screw clips.

Constant 24Vdc voltage supply  
Parallel connection, 50 cm cable

Constant voltage power supplies page 237  
Dimming Accessories page 249

 **MADE IN ITALY**

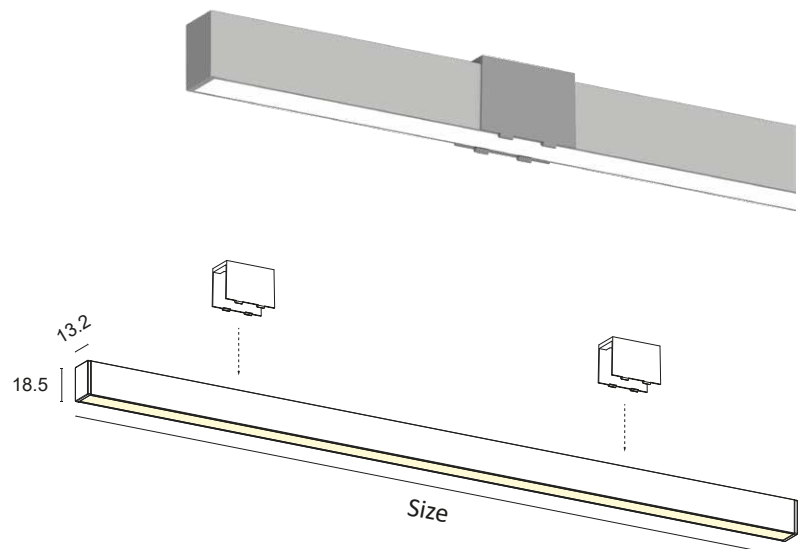
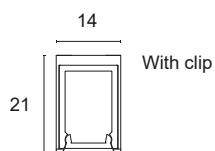
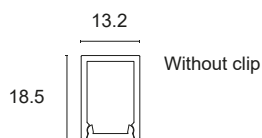

BASIC CODES

**J1.**

FINISHES

- 1** White
  - 2** Matt black
  - 7** Brushed aluminium
- \*Other finishes on request.

SIDE SUPPORTS

- 1** White
- 2** Matt black
- 5** Grey
- 7** Brushed aluminium

SIDE SUPPORTS + TOUCH

- 1T** White
- 2T** Matt black
- 5T** Grey
- 7T** Brushed aluminium

SIZE

- A** 300mm
- B** 450mm
- C** 500mm
- D** 600mm
- E** 700mm
- F** 800mm
- G** 900mm
- H** 1000mm
- I** 1200mm
- J** 1300mm
- K** 1400mm
- L** 1500mm
- M** 1800mm
- N** 2000mm
- O** 2300mm
- P** 2500mm
- Q** 2800mm
- R** 3000mm

LED COLOUR

- BN** 4000K
  - BC** 3000K
  - CC** 2700K
- \*Strip also available coloured, Dynamic White, RGB.

POWER

- |            |         |          |                |        |  |
|------------|---------|----------|----------------|--------|--|
| <b>D</b>   | 10W/m   | 1400Lm/m | 98LED/m S2835  | CRI>85 |  |
| <b>D+</b>  | 10W/m   | 1400Lm/m | 112LED/m S2835 | CRI>90 |  |
| <b>E</b>   | 16.8W/m | 2000Lm/m | 140LED/m S2835 | CRI>85 |  |
| <b>E+</b>  | 16.8W/m | 2000Lm/m | 140LED/m S2835 | CRI>90 |  |
| <b>F</b>   | 20.2W/m | 2500Lm/m | 168LED/m S2835 | CRI>85 |  |
| <b>F+</b>  | 20.2W/m | 2500Lm/m | 168LED/m S2835 | CRI>90 |  |
| <b>G</b>   | 25W/m   | 3500Lm/m | 160LED/m S2835 | CRI>80 |  |
| <b>L+</b>  | 28W/m   | 3500Lm/m | 160LED/m S2835 | CRI>90 |  |
| <b>C1+</b> | 10W/m   | 1050Lm/m | COB LED        | CRI>90 |  |

\*Energy class referring to light source

DIFFUSER

- S** BRUSHED

Code example:

JEY 1 + White + Side supports white + 1000mm + 3000K + 10W/m CRI>85 + Brushed diffuser = Code: J1.11HBCDS

# JEY 2

J2.



Decorated anodised aluminium lamp complete with press-fit brushed diffuser, side supports and LED source with a high Lumen/Watt ratio. Suitable for furnishing lighting and general lighting.  
Mounting with recessed screws.

Constant 24Vdc voltage supply  
Parallel connection, 50 cm cable

Constant voltage power supplies page 237

Dimming Accessories page 249

 **MADE IN ITALY**

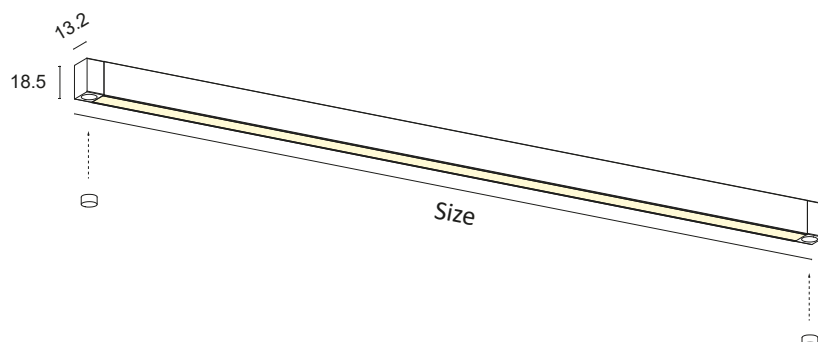
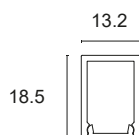
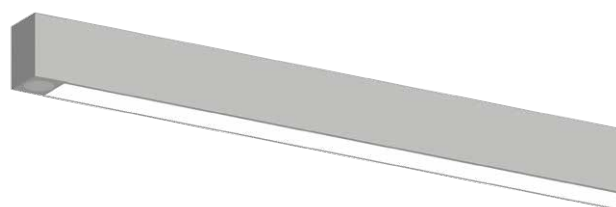

BASIC CODES

**J2.**

FINISHES

- 1** White
  - 2** Matt black
  - 7** Brushed aluminium
- \*Other finishes on request.

SIDE SUPPORTS

- 1** White
- 2** Matt black
- 5** Grey
- 7** Brushed aluminium

SIZE

- C** 500mm
- D** 600mm
- E** 700mm
- F** 800mm
- G** 900mm
- H** 1000mm
- I** 1200mm
- J** 1300mm
- K** 1400mm
- L** 1500mm
- M** 1800mm

LED COLOUR

- BN** 4000K
  - BC** 3000K
  - CC** 2700K
- \*Strip also available coloured, Dynamic White, RGB.

POWER

<b>D</b>	10W/m	1400Lm/m	98LED/m	S2835	CRI>85	
<b>D+</b>	10W/m	1400Lm/m	112LED/m	S2835	CRI>90	
<b>E</b>	16.8W/m	2000Lm/m	140LED/m	S2835	CRI>85	
<b>E+</b>	16.8W/m	2000Lm/m	140LED/m	S2835	CRI>90	
<b>F</b>	20.2W/m	2500Lm/m	168LED/m	S2835	CRI>85	
<b>F+</b>	20.2W/m	2500Lm/m	168LED/m	S2835	CRI>90	
<b>G</b>	25W/m	3500Lm/m	160LED/m	S2835	CRI>80	
<b>L+</b>	28W/m	3500Lm/m	160LED/m	S2835	CRI>90	
<b>C1+</b>	10W/m	1050Lm/m	COB LED		CRI>90	

\*Energy class referring to light source

DIFFUSER

- S** BRUSHED

Code example:

JEY 2 + White + Side supports white + 1000mm + 3000K + 10W/m CRI>85 + Brushed diffuser = Code: J2.11HBCDS

# ZETA 1

Z1.



Decorated anodised aluminium lamp complete with press-fit brushed or transparent diffuser, side supports and LED source with a high Lumen/Watt ratio. Wide availability of accessories that can be integrated into the profile. Suitable for accent and service lighting, suitable for furniture, residential, retail and general lighting. Mounting with recessed screws.

Constant 24Vdc voltage supply  
Parallel connection, 50 cm cable

Constant voltage power supplies page 237

Dimming Accessories page 249

 **MADE IN ITALY**

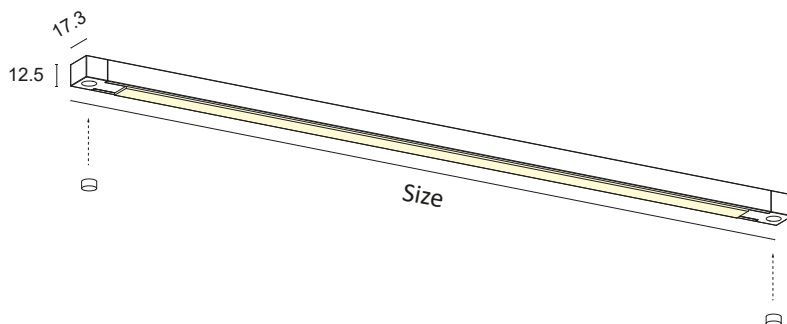
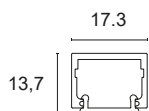
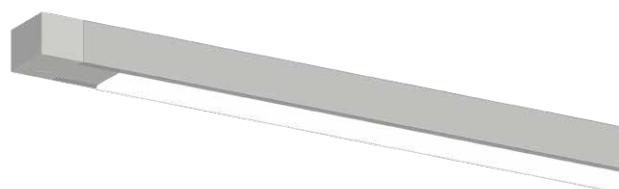



BASIC CODES

**Z1.**

FINISHES

- 1** White
  - 2** Matt black
  - 7** Brushed aluminium
- \*Other finishes on request.

SIDE SUPPORTS

- 1** White
- 2** Matt black
- 5** Grey
- 7** Brushed aluminium

SIDE SUPPORTS + TOUCH

- 1T** White
- 2T** Matt black
- 5T** Grey
- 7T** Brushed aluminium

SIDE SUPPORTS + SENSOR

- 1S** White
- 2S** Matt black
- 5S** Grey
- 7S** Brushed aluminium

SIDE SUPPORTS + ON/OFF

- 1I** White
- 2I** Matt black
- 5I** Grey
- 7I** Brushed aluminium

SIZE

- A** 300mm
- B** 450mm
- C** 500mm
- D** 600mm
- E** 700mm
- F** 800mm
- G** 900mm
- H** 1000mm
- I** 1200mm
- J** 1300mm
- K** 1400mm
- L** 1500mm
- M** 1800mm
- N** 2000mm
- O** 2300mm
- P** 2500mm
- Q** 2800mm
- R** 3000mm

LED COLOUR

- BN** 4000K
  - BC** 3000K
  - CC** 2700K
- \*Strip also available coloured, Dynamic White, RGB and RGBW.

POWER

<b>D</b>	10W/m	1400Lm/m	98LED/m	S2835	CRI>85	
<b>D+</b>	10W/m	1600Lm/m	112LED/m	S2835	CRI>90	
<b>E</b>	16.8W/m	2000Lm/m	140LED/m	S2835	CRI>85	
<b>E+</b>	16.8W/m	2000Lm/m	140LED/m	S2835	CRI>90	
<b>F</b>	20.2W/m	2500Lm/m	168LED/m	S2835	CRI>85	
<b>F+</b>	20.2W/m	2500Lm/m	168LED/m	S2835	CRI>90	
<b>G</b>	25W/m	3500Lm/m	160LED/m	S2835	CRI>80	
<b>L+</b>	28W/m	3500Lm/m	160LED/m	S2835	CRI>90	
<b>G2+</b>	15W/m	1550Lm/m	COB LED		CRI>90	

\*Energy class referring to light source

DIFFUSER

- S** BRUSHED
- T** TRANSPARENT

Code example:

ZETA 1 + White + Side supports white + 1000mm + 3000K + 10W/m CRI>85 + Brushed diffuser = Code: Z1.11HBCDS

# ZETA 2

Z2.



Decorated anodised aluminium lamp complete with press-fit brushed or transparent diffuser, side supports and LED source with a high Lumen/Watt ratio. Wide availability of accessories that can be integrated into the profile. Suitable for accent and service lighting, suitable for furniture, residential, retail and general lighting. Mounting with screw clips.

Constant 24Vdc voltage supply  
Parallel connection, 50 cm cable

Constant voltage power supplies page 237

Dimming Accessories page 249

 **MADE IN ITALY**

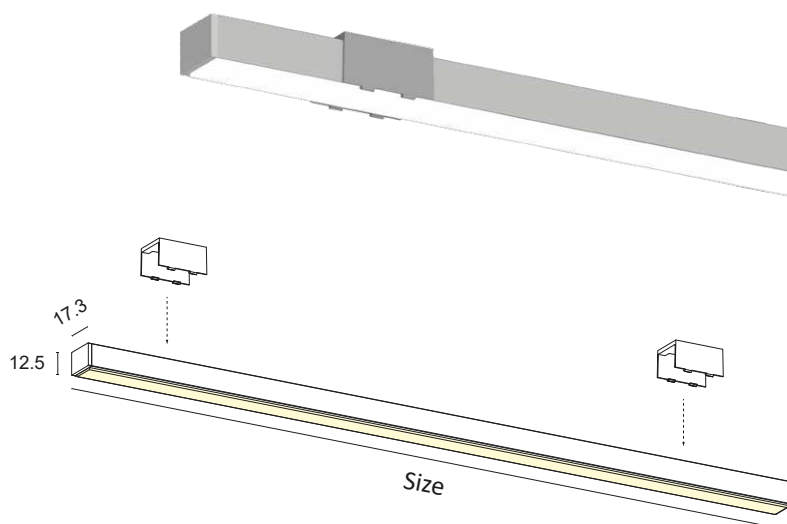
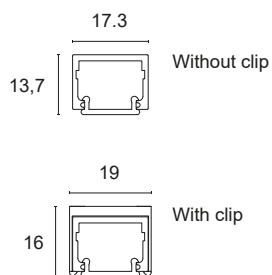

BASIC CODES

**Z2.**

FINISHES

- 1** White
  - 2** Matt black
  - 7** Brushed aluminium
- \*Other finishes on request.

SIDE SUPPORTS

- 1** White
- 2** Matt black
- 5** Grey
- 7** Brushed aluminium

SIDE SUPPORTS + TOUCH

- 1T** White
- 2T** Matt black
- 5T** Grey
- 7T** Brushed aluminium

SIDE SUPPORTS + SENSOR

- 1S** White
- 2S** Matt black
- 5S** Grey
- 7S** Brushed aluminium

SIZE

- A** 300mm
- B** 450mm
- C** 500mm
- D** 600mm
- E** 700mm
- F** 800mm
- G** 900mm
- H** 1000mm
- I** 1200mm
- J** 1300mm
- K** 1400mm
- L** 1500mm
- M** 1800mm
- N** 2000mm
- O** 2300mm
- P** 2500mm
- Q** 2800mm
- R** 3000mm

LED COLOUR

- BN** 4000K
  - BC** 3000K
  - CC** 2700K
- \*Strip also available coloured, Dynamic White, RGB and RGBW.

POWER

<b>D</b>	10W/m	1400Lm/m	98LED/m	S2835	CRI>85	
<b>D+</b>	10W/m	1600Lm/m	112LED/m	S2835	CRI>90	
<b>E</b>	16.8W/m	2000Lm/m	140LED/m	S2835	CRI>85	
<b>E+</b>	16.8W/m	2000Lm/m	140LED/m	S2835	CRI>90	
<b>F</b>	20.2W/m	2500Lm/m	168LED/m	S2835	CRI>85	
<b>F+</b>	20.2W/m	2500Lm/m	168LED/m	S2835	CRI>90	
<b>G</b>	25W/m	3500Lm/m	160LED/m	S2835	CRI>80	
<b>L+</b>	28W/m	3500Lm/m	160LED/m	S2835	CRI>90	
<b>G2+</b>	15W/m	1550Lm/m	COB LED		CRI>90	

\*Energy class referring to light source

DIFFUSER

- S** BRUSHED
- T** TRANSPARENT

Code example:

ZETA 2 + White + Side supports white + 1000mm + 3000K + 10W/m CRI>85 + Brushed diffuser = Code: Z2.11HBCDS

# RHO 3

R3.



Decorated anodised aluminium lamp complete with press-fit brushed or microprismatic diffuser, side supports and LED source with a high Lumen/Watt ratio. Suitable for furnishing lighting and general lighting. Mounting with screw clips.

Constant 24Vdc voltage supply  
Parallel connection, 50 cm cable

Constant voltage power supplies page 237  
Dimming Accessories page 249

 **MADE IN ITALY**

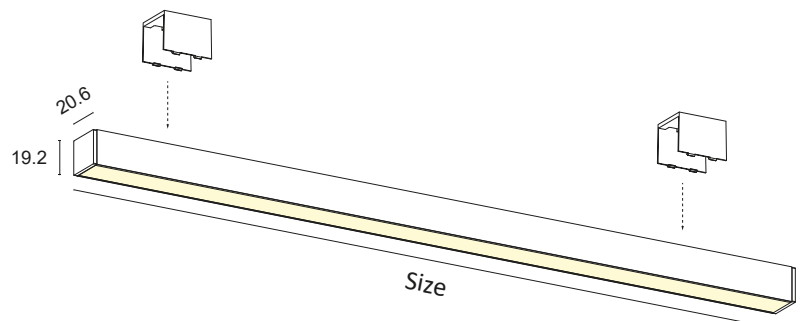
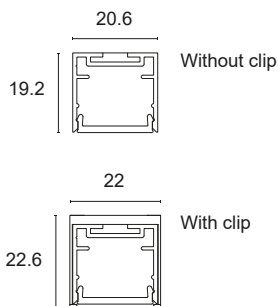
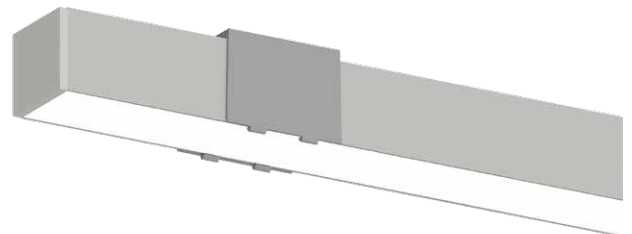

BASIC CODES

**R3.**

FINISHES

- 1** White
  - 2** Matt black
  - 7** Brushed aluminium
- \*Other finishes on request.

SIDE SUPPORTS

- 1** White
- 2** Matt black
- 7** Brushed aluminium

SIZE

- C** 500mm
- D** 600mm
- E** 700mm
- F** 800mm
- G** 900mm
- H** 1000mm
- I** 1200mm
- J** 1300mm
- K** 1400mm
- L** 1500mm
- M** 1800mm
- N** 2000mm
- O** 2300mm
- P** 2500mm
- Q** 2800mm
- R** 3000mm

LED COLOUR

- BN** 4000K
  - BC** 3000K
  - CC** 2700K
- \*Strip also available coloured, Dynamic White, RGB and RGBW.

POWER

- |           |         |          |          |       |        |   |
|-----------|---------|----------|----------|-------|--------|---|
| <b>E</b>  | 16.8W/m | 2000Lm/m | 140LED/m | S2835 | CRI>85 |    |
| <b>E+</b> | 16.8W/m | 2000Lm/m | 140LED/m | S2835 | CRI>90 |    |
| <b>F</b>  | 20.2W/m | 2500Lm/m | 168LED/m | S2835 | CRI>85 |  |
| <b>F+</b> | 20.2W/m | 2500Lm/m | 168LED/m | S2835 | CRI>90 |  |
| <b>G</b>  | 25W/m   | 3500Lm/m | 160LED/m | S2835 | CRI>80 |  |
| <b>L+</b> | 28W/m   | 3500Lm/m | 160LED/m | S2835 | CRI>90 |  |
| <b>H</b>  | 30W/m   | 4500Lm/m | 240LED/m | S2835 | CRI>80 |  |

\*Energy class referring to light source

DIFFUSER

- M** MICROPRISMATIC
- S** BRUSHED

Code example:

RHO 3 + White + Side supports white + 1000mm + 3000K + 25W/m CRI>80 + Brushed diffuser = Code: R3.11HBCGS



# VELA 1

V1.



Decorated anodised aluminium lamp complete with press-fit brushed diffuser , side supports and LED source with a high Lumen/Watt ratio. Wide availability of accessories that can be integrated into the profile. Suitable for primary residential and general lighting. Mounting with recessed screws.

Constant 24Vdc voltage supply  
Parallel connection, 50 cm cable

Constant voltage power supplies page 237  
Dimming Accessories page 249

 **MADE IN ITALY**

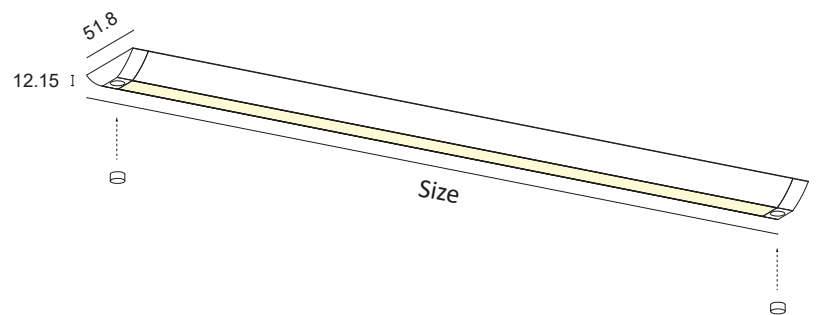
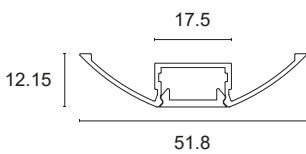
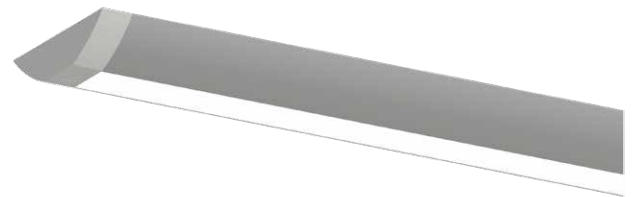

**BASIC CODES**

**V1.**

**FINISHES**

- 1** White
  - 2** Matt black
  - 7** Brushed aluminium
- \*Other finishes on request.

**SIDE SUPPORTS**

- 1** White
- 2** Matt black
- 5** Grey
- 7** Brushed aluminium

**SIDE SUPPORTS + TOUCH**

- 1T** White
- 2T** Matt black
- 5T** Grey
- 7T** Brushed aluminium

**SIDE SUPPORTS + SENSOR**

- 1S** White
- 2S** Matt black
- 5S** Grey
- 7S** Brushed aluminium

**SIZE**

- A** 300mm
- B** 450mm
- C** 500mm
- D** 600mm
- E** 700mm
- F** 800mm
- G** 900mm
- H** 1000mm
- I** 1200mm
- J** 1300mm
- K** 1400mm
- L** 1500mm
- M** 1800mm
- N** 2000mm
- O** 2300mm
- P** 2500mm
- Q** 2800mm
- R** 3000mm

**LED COLOUR**

- BN** 4000K
  - BC** 3000K
  - CC** 2700K
- \*Strip also available coloured, Dynamic White, RGB and RGBW.

**POWER**

<b>E</b>	16.8W/m	2000Lm/m	140LED/m	S2835	CRI>85	
<b>E+</b>	16.8W/m	2000Lm/m	140LED/m	S2835	CRI>90	
<b>F</b>	20.2W/m	2500Lm/m	168LED/m	S2835	CRI>85	
<b>F+</b>	20.2W/m	2500Lm/m	168LED/m	S2835	CRI>90	
<b>G</b>	25W/m	3500Lm/m	160LED/m	S2835	CRI>80	
<b>L+</b>	28W/m	3500Lm/m	160LED/m	S2835	CRI>90	
<b>H</b>	30W/m	4500Lm/m	240LED/m	S2835	CRI>80	

\*Energy class referring to light source

**DIFFUSER**

- S** BRUSHED

**Code example:**

VELA 1 + White + Side supports white + 1000mm + 3000K + 25W/m CRI>80 + Brushed diffuser = Code: V1.11HBCGS

# VELA 2

V2.



Decorated anodised aluminium lamp complete with press-fit brushed diffuser , side supports and LED source with a high Lumen/Watt ratio. Wide availability of accessories that can be integrated into the profile. Suitable for primary residential and general lighting. Mounting with recessed clips.

Constant 24Vdc voltage supply  
Parallel connection, 50 cm cable

Constant voltage power supplies page 237  
Dimming Accessories page 249

 **MADE IN ITALY**

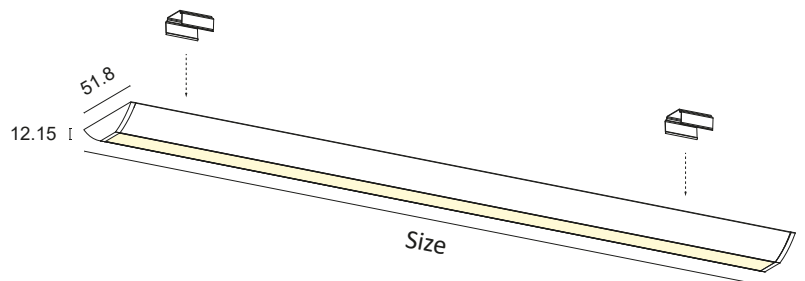
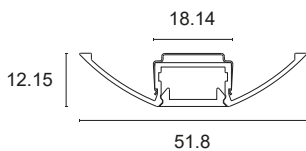

BASIC CODES

**V2.**

FINISHES

- 1** White
  - 2** Matt black
  - 7** Brushed aluminium
- \*Other finishes on request.

SIDE SUPPORTS

- 1** White
- 2** Matt black
- 7** Brushed aluminium

SIDE SUPPORTS + TOUCH

- 1T** White
- 2T** Matt black
- 7T** Brushed aluminium

SIDE SUPPORTS + SENSOR

- 1S** White
- 2S** Matt black
- 7S** Brushed aluminium

SIZE

- A** 300mm
- B** 450mm
- C** 500mm
- D** 600mm
- E** 700mm
- F** 800mm
- G** 900mm
- H** 1000mm
- I** 1200mm
- J** 1300mm
- K** 1400mm
- L** 1500mm
- M** 1800mm
- N** 2000mm
- O** 2300mm
- P** 2500mm
- Q** 2800mm
- R** 3000mm

LED COLOUR

- BN** 4000K
  - BC** 3000K
  - CC** 2700K
- \*Strip also available coloured, Dynamic White, RGB and RGBW.

POWER

<b>E</b>	16.8W/m	2000Lm/m	140LED/m	S2835	CRI>85	
<b>E+</b>	16.8W/m	2000Lm/m	140LED/m	S2835	CRI>90	
<b>F</b>	20.2W/m	2500Lm/m	168LED/m	S2835	CRI>85	
<b>F+</b>	20.2W/m	2500Lm/m	168LED/m	S2835	CRI>90	
<b>G</b>	25W/m	3500Lm/m	160LED/m	S2835	CRI>80	
<b>L+</b>	28W/m	3500Lm/m	160LED/m	S2835	CRI>90	
<b>H</b>	30W/m	4500Lm/m	240LED/m	S2835	CRI>80	

\*Energy class referring to light source

DIFFUSER

- S** BRUSHED

Code example:

VELA 2 + White + Side supports white + 1000mm + 3000K + 25W/m CRI>80 + Brushed diffuser = Code: V2.11HBCGS

# GAMMA

## G1.



Decorated anodised aluminium lamp complete with press-fit brushed diffuser , side supports and LED source with a high Lumen/Watt ratio. Wide availability of accessories that can be integrated into the profile. Suitable for under-wall cupboard, furnishing lighting, panel and general lighting. Mounting with screw clips.

Constant 24Vdc voltage supply  
Parallel connection, 50 cm cable

Constant voltage power supplies page 237  
Dimming Accessories page 249

 **MADE IN ITALY**

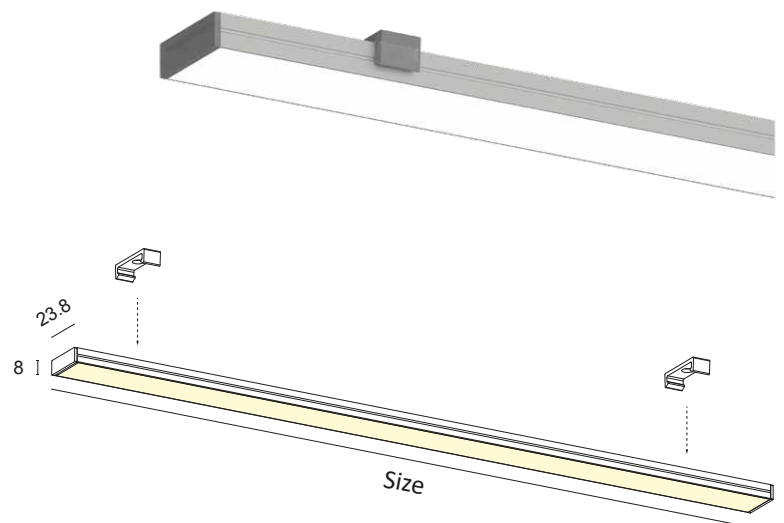
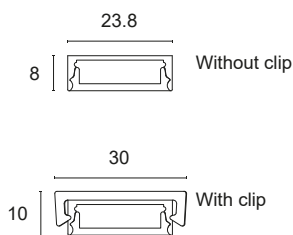



BASIC CODES

**G1.**

FINISHES

- 1** White
  - 2** Matt black
  - 7** Brushed aluminium
- \*Other finishes on request.

SIDE SUPPORTS

- 1** White
- 2** Matt black
- 5** Grey
- 7** Brushed aluminium

SIDE SUPPORTS + TOUCH

- 1T** White
- 2T** Matt black
- 5T** Grey
- 7T** Brushed aluminium

SIDE SUPPORTS + SENSOR

- 1S** White
- 2S** Matt black
- 5S** Grey
- 7S** Brushed aluminium

SIZE

- A** 300mm
- B** 450mm
- C** 500mm
- D** 600mm
- E** 700mm
- F** 800mm
- G** 900mm
- H** 1000mm
- I** 1200mm
- J** 1300mm
- K** 1400mm
- L** 1500mm
- M** 1800mm
- N** 2000mm
- O** 2300mm
- P** 2500mm
- Q** 2800mm
- R** 3000mm

LED COLOUR

- BN** 4000K
  - BC** 3000K
  - CC** 2700K
- \*Strip also available coloured, Dynamic White, RGB and RGBW.

POWER

- |            |         |          |          |       |        |  |
|------------|---------|----------|----------|-------|--------|--|
| <b>E</b>   | 16.8W/m | 2000Lm/m | 140LED/m | S2835 | CRI>85 |  |
| <b>E+</b>  | 16.8W/m | 2000Lm/m | 140LED/m | S2835 | CRI>90 |  |
| <b>F</b>   | 20.2W/m | 2500Lm/m | 168LED/m | S2835 | CRI>85 |  |
| <b>F+</b>  | 20.2W/m | 2500Lm/m | 168LED/m | S2835 | CRI>90 |  |
| <b>G</b>   | 25W/m   | 3500Lm/m | 160LED/m | S2835 | CRI>80 |  |
| <b>L+</b>  | 28W/m   | 3500Lm/m | 160LED/m | S2835 | CRI>90 |  |
| <b>H</b>   | 30W/m   | 4500Lm/m | 240LED/m | S2835 | CRI>80 |  |
| <b>C1+</b> | 10W/m   | 1050Lm/m | COB LED  |       | CRI>90 |  |
| <b>C2+</b> | 15W/m   | 1550Lm/m | COB LED  |       | CRI>90 |  |

\*Energy class referring to light source

DIFFUSER

- S** BRUSHED

Code example:

GAMMA + White + Side supports white + 1000mm + 3000K + 16.8W/m CRI>85 + Brushed diffuser = Code: G1.11HBCES

# VEGA

## VG1.



Decorated anodised aluminium lamp complete with press-fit brushed diffuser , side supports and LED source with a high Lumen/Watt ratio. 45° light emission, possibility of integrating an on/off Touch system into the edge. Suitable for under-wall cupboard, furnishing lighting, panel and general lighting. Mounting with screw clips or magnets.

Constant 24Vdc voltage supply  
Parallel connection, 50 cm cable

Constant voltage power supplies page 237

Dimming Accessories page 249

 **MADE IN ITALY**

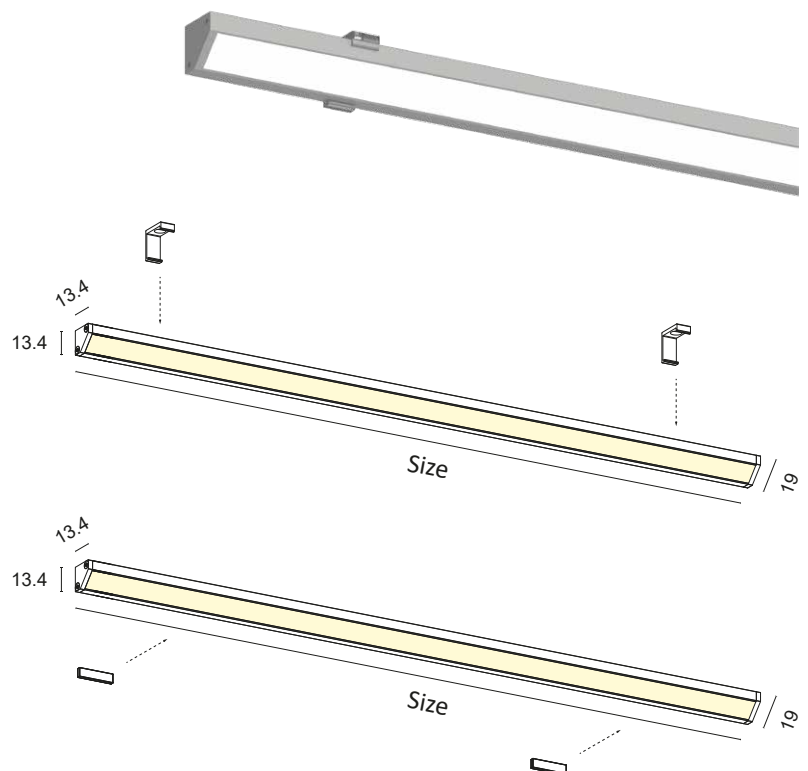
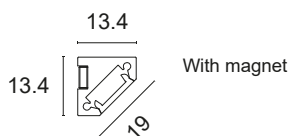
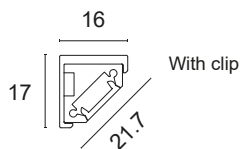

**BASIC CODES**

**VG1.**

**FINISHES**

- 1** White
  - 2** Matt black
  - 7** Brushed aluminium
- \*Other finishes on request.

**SIDE SUPPORTS**

- 1** White
- 2** Matt black
- 7** Brushed aluminium

**SIDE SUPPORTS + TOUCH**

- 1T** White
- 2T** Matt black
- 7T** Brushed aluminium

**SIZE**

- A** 300mm
- B** 450mm
- C** 500mm
- D** 600mm
- E** 700mm
- F** 800mm
- G** 900mm
- H** 1000mm
- I** 1200mm
- J** 1300mm
- K** 1400mm
- L** 1500mm
- M** 1800mm
- N** 2000mm
- O** 2300mm
- P** 2500mm
- Q** 2800mm
- R** 3000mm

**LED COLOUR**

- BN** 4000K
  - BC** 3000K
  - CC** 2700K
- \*Strip also available coloured, Dynamic White, RGB.

**POWER**

- |            |         |          |          |       |        |  |
|------------|---------|----------|----------|-------|--------|--|
| <b>D</b>   | 10W/m   | 1400Lm/m | 98LED/m  | S2835 | CRI>85 |  |
| <b>D+</b>  | 10W/m   | 1600Lm/m | 112LED/m | S2835 | CRI>90 |  |
| <b>E</b>   | 16.8W/m | 2000Lm/m | 140LED/m | S2835 | CRI>85 |  |
| <b>E+</b>  | 16.8W/m | 2000Lm/m | 140LED/m | S2835 | CRI>90 |  |
| <b>F</b>   | 20.2W/m | 2500Lm/m | 168LED/m | S2835 | CRI>85 |  |
| <b>F+</b>  | 20.2W/m | 2500Lm/m | 168LED/m | S2835 | CRI>90 |  |
| <b>P+</b>  | 14.4W/m | 1100Lm/m | 180LED/m | S2216 | CRI>90 |  |
| <b>C2+</b> | 15W/m   | 1550Lm/m | COB LED  |       | CRI>90 |  |

\*Energy class referring to light source

**DIFFUSER**

- S** BRUSHED

**Code example:**

VEGA + White + Side supports white + 1000mm + 3000K + 10W/m CRI>85 + Brushed diffuser = Code: VG1.11HBCDS

**ACCESSORIES TO BE ORDERED SEPARATELY**

**BASIC CODES**

**SVG2.8**

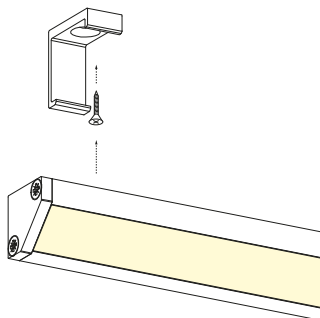

Transparent polycarbonate clip with 12xM2.5 screws for surface mounting on a variety of surfaces. adhered to the surface. 12xM2.5 screws included.

**NB.** We recommend No. 1 Clip per 500mm

**BASIC CODES**

**NDL40XP5X2**

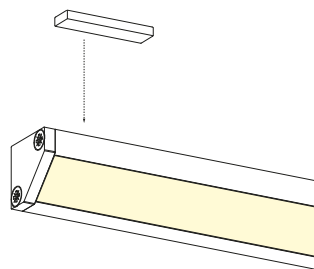

Magnets to glue on for fixing on smooth metal surfaces.

**NB.** We recommend No. 1 magnet every 150mm (Max. attraction force 1.60kg).

# BETA

## B1.



Decorated anodised aluminium lamp complete with press-fit brushed diffuser , side supports and LED source with a high Lumen/Watt ratio. 45° light emission, wide availability of accessories that can be integrated into the profile. Suitable for under-wall cupboard, furnishing lighting, panel and general lighting. Mounting with screw clips.

Constant 24Vdc voltage supply  
Parallel connection, 50 cm cable

Constant voltage power supplies page 237

Dimming Accessories page 249

 **MADE IN ITALY**

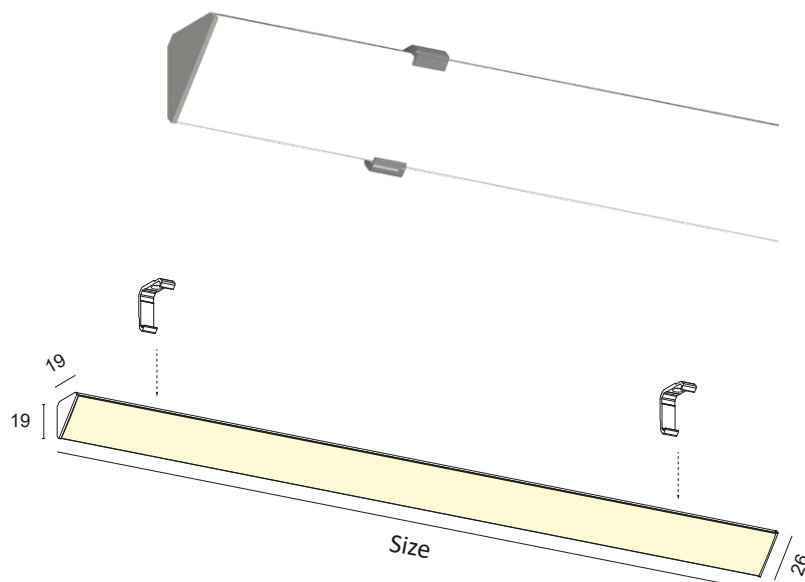
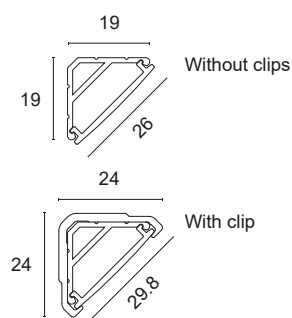

BASIC CODES

**B1.**

FINISHES

- 1** White
  - 2** Matt black
  - 7** Brushed aluminium
- \*Other finishes on request.

SIDE SUPPORTS

- 1** White
- 2** Matt black
- 7** Brushed aluminium

SIDE SUPPORTS + TOUCH

- 1T** White
- 2T** Matt black
- 5T** Grey
- 7T** Brushed aluminium

SIDE SUPPORTS + SENSOR

- 1S** White
- 2S** Matt black
- 5S** Grey
- 7S** Brushed aluminium

SIZE

- A** 300mm
- B** 450mm
- C** 500mm
- D** 600mm
- E** 700mm
- F** 800mm
- G** 900mm
- H** 1000mm
- I** 1200mm
- J** 1300mm
- K** 1400mm
- L** 1500mm
- M** 1800mm
- N** 2000mm
- O** 2300mm
- P** 2500mm
- Q** 2800mm
- R** 3000mm

LED COLOUR

- BN** 4000K
  - BC** 3000K
  - CC** 2700K
- \*Strip also available coloured, Dynamic White, RGB and RGBW.

POWER

<b>D</b>	10W/m	1400Lm/m	98LED/m	S2835	CRI>85	
<b>D+</b>	10W/m	1600Lm/m	112LED/m	S2835	CRI>90	
<b>E</b>	16.8W/m	2000Lm/m	140LED/m	S2835	CRI>85	
<b>E+</b>	16.8W/m	2000Lm/m	140LED/m	S2835	CRI>90	
<b>F</b>	20.2W/m	2500Lm/m	168LED/m	S2835	CRI>85	
<b>F+</b>	20.2W/m	2500Lm/m	168LED/m	S2835	CRI>90	
<b>G</b>	25W/m	3500Lm/m	160LED/m	S2835	CRI>80	
<b>L+</b>	28W/m	3500Lm/m	160LED/m	S2835	CRI>90	
<b>H</b>	30W/m	4500Lm/m	240LED/m	S2835	CRI>80	

\*Energy class referring to light source

DIFFUSER

- S** BRUSHED
- T** TRANSPARENT

Code example:

BETA + White + Side supports white + 1000mm + 3000K + 25W/m CRI>80 + Brushed diffuser = Code: B1.11HBCGS



# DELTA 1

D1.



Decorated anodised aluminium lamp complete with brushed or microprismatic diffuser and high-brightness LED source with a high Lumen/Watt ratio. Suitable for primary residential, retail, large-space and general lighting. Mounting on ceiling with concealed clips.

Constant 24Vdc voltage supply  
Parallel connection, 50 cm cable

Constant voltage power supplies page 237

Dimming Accessories page 249

 **MADE IN ITALY**

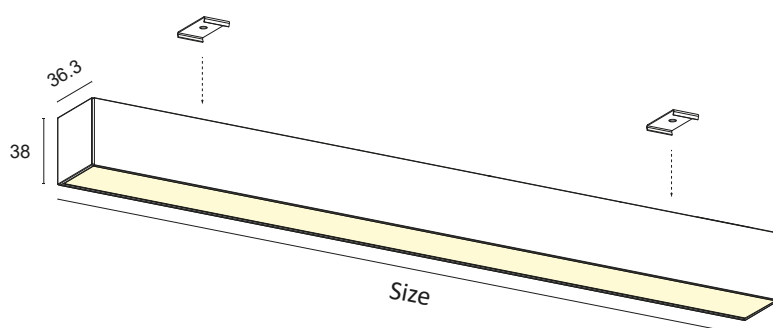
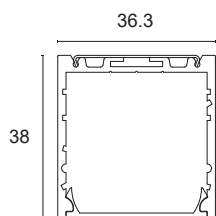
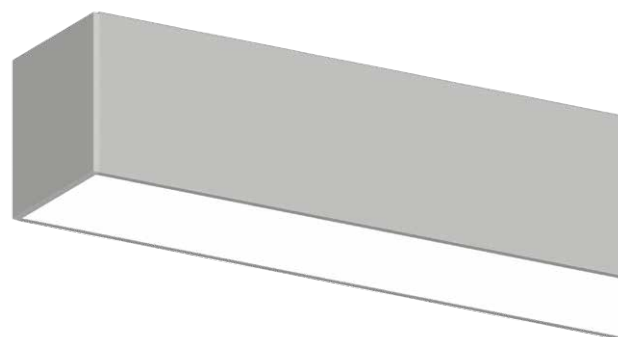

**BASIC CODES**

**D1.**

**FINISHES**

- **1** White
  - **2** Matt black
  - **7** Brushed aluminium
- \*Other finishes on request.

**SIDE SUPPORTS**

- **1** White
- **2** Matt black
- **5** Grey
- **7** Brushed aluminium

**SIZE**

- C** 500mm
- D** 600mm
- E** 700mm
- F** 800mm
- G** 900mm
- H** 1000mm
- I** 1200mm
- J** 1300mm
- K** 1400mm
- L** 1500mm
- M** 1800mm
- N** 2000mm
- O** 2300mm
- P** 2500mm
- Q** 2800mm
- R** 3000mm

**LED COLOUR**

- **BN** 4000K
  - **BC** 3000K
  - **CC** 2700K
- \*Strip also available coloured, Dynamic White, RGB and RGBW.

**POWER**

<b>F</b>	20.2W/m	2500Lm/m	168LED/m	S2835	CRI>85	
<b>F+</b>	20.2W/m	2500Lm/m	168LED/m	S2835	CRI>90	
<b>G</b>	25W/m	3500Lm/m	160LED/m	S2835	CRI>80	
<b>L+</b>	28W/m	3500Lm/m	160LED/m	S2835	CRI>90	
<b>H</b>	30W/m	4500Lm/m	240LED/m	S2835	CRI>80	
<b>M+</b>	40W/m	5000Lm/m	480LED/m	S2835	CRI>90	

\*Energy class referring to light source

**DIFFUSER**

- M** MICROPRISMATIC
- S** BRUSHED

**Code example:**

DELTA 1 + White + Side supports white + 900mm + 3000K + 20.2W/m CRI>85 + Brushed diffuser = Code: D1.11GBCFS

## COMPLEMENTARY SYSTEMS

**EXAMPLE OF DELTA CEILING LIGHT AND REM PROJECTOR**

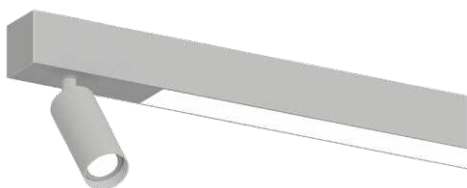

\*Details on p. 276

**EXAMPLE OF DELTA CEILING LIGHT AND DARK MODULE**

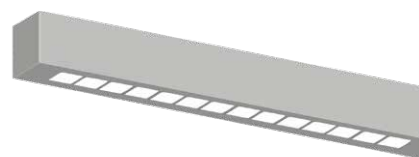

\*Details on p. 276

**EXAMPLE OF DELTA CEILING LIGHT, REM AND DARK MODULE**

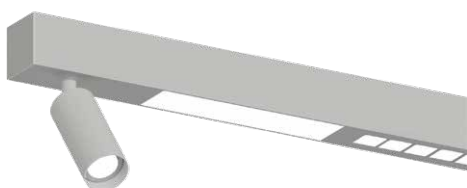

\*Details on p. 276

# KAPPA 3

K3.



Decorated anodised aluminium lamp complete with brushed or microprismatic diffuser and high-brightness LED source with a high Lumen/Watt ratio. Suitable for primary residential, retail, large-space and general lighting. Ceiling mounting with concealed magnets, plus steel safety cables.

Constant 24Vdc voltage supply  
Parallel connection, 50 cm cable

Constant voltage power supplies page 237

Dimming Accessories page 249

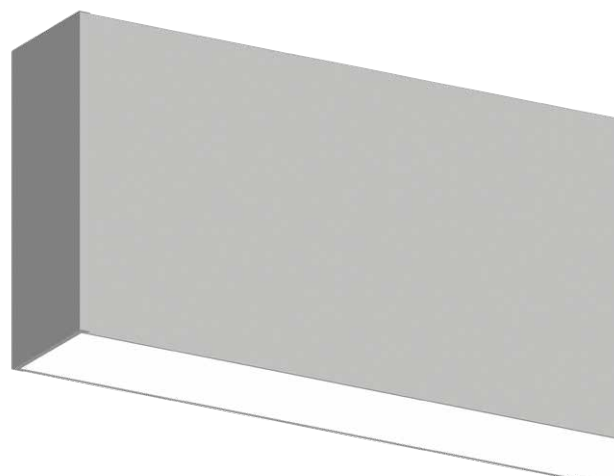

 **MADE IN ITALY**

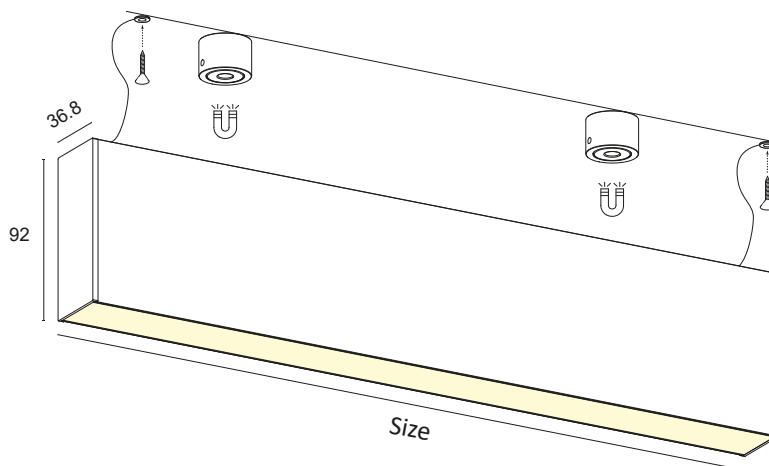
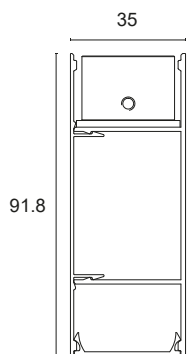

**BASIC CODES**

**K3.**

**FINISHES**

- 1** White
  - 2** Matt black
  - 7** Brushed aluminium
- \*Other finishes on request.

**SIDE SUPPORTS**

- 1** White
- 2** Matt black
- 7** Brushed aluminium

**SIZE**

- D** 600mm
- E** 700mm
- F** 800mm
- G** 900mm
- H** 1000mm
- I** 1200mm
- J** 1300mm
- K** 1400mm
- L** 1500mm
- M** 1800mm
- N** 2000mm
- O** 2300mm
- P** 2500mm
- Q** 2800mm
- R** 3000mm

**LED COLOUR**

- BN** 4000K
  - BC** 3000K
  - CC** 2700K
- \*Strip also available coloured, Dynamic White, RGB and RGBW.

**POWER**

- |           |         |          |          |       |        |   |
|-----------|---------|----------|----------|-------|--------|---|
| <b>F</b>  | 20.2W/m | 2500Lm/m | 168LED/m | S2835 | CRI>85 |    |
| <b>F+</b> | 20.2W/m | 2500Lm/m | 168LED/m | S2835 | CRI>90 |    |
| <b>G</b>  | 25W/m   | 3500Lm/m | 160LED/m | S2835 | CRI>80 |   |
| <b>L+</b> | 28W/m   | 3500Lm/m | 160LED/m | S2835 | CRI>90 |  |
| <b>H</b>  | 30W/m   | 4500Lm/m | 240LED/m | S2835 | CRI>80 |  |
| <b>M+</b> | 40W/m   | 5000Lm/m | 480LED/m | S2835 | CRI>90 |  |

\*Energy class referring to light source

**DIFFUSER**

- M** MICROPRISMATIC
- S** BRUSHED

**POWER SUPPLY**

- N** ON/OFF
  - D** DALI + PUSH
- \*The lamp can be customised with independent switch-on and dimming on request.

**Code example:**

KAPPA 3 + White + Side supports white + 1000mm + 3000K + 25W/m CRI>80 + Brushed diffuser + ON/OFF = Code: K3.11HBCGSN

**COMPLEMENTARY SYSTEMS**

**EXAMPLE OF KAPPA CEILING LIGHT AND REM PROJECTOR**

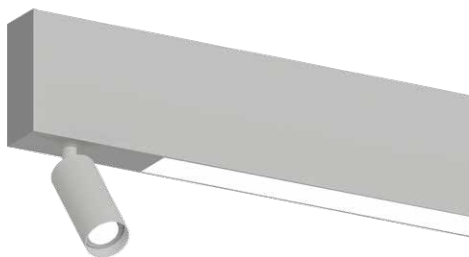

\*Details on p. 276

**EXAMPLE OF KAPPA CEILING LIGHT AND DARK MODULE**

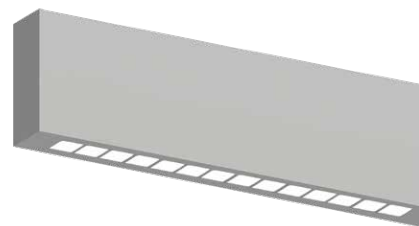

\*Details on p. 276

**EXAMPLE OF KAPPA CEILING LIGHT, REM AND DARK MODULE**

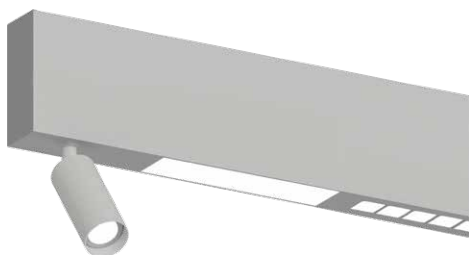

\*Details on p. 276

# QU

## Q1.



Polycarbonate lamp complete with aluminium heat sink and high-brightness LED source with a high Lumen/Watt ratio. Suitable for accent lighting of furnishing, retail and general lighting.

Constant 24Vdc voltage supply  
Parallel connection, 50 cm cable

Constant voltage power supplies page 237  
Dimming Accessories page 249

 **MADE IN ITALY**

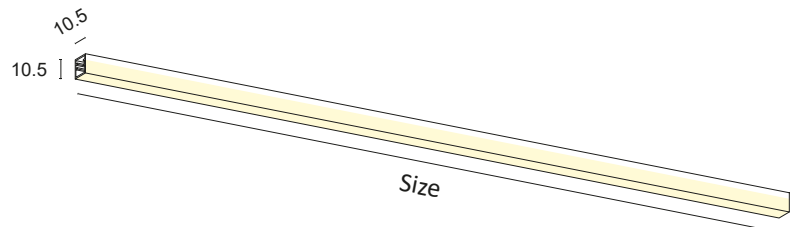
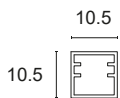
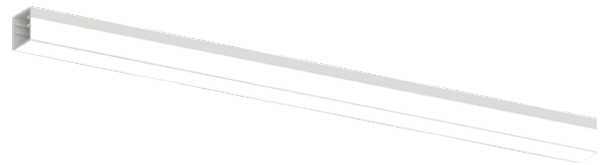



BASIC CODES

**Q1.**

SIZE

- A** 300mm
- B** 450mm
- C** 500mm
- D** 600mm
- E** 700mm
- F** 800mm
- G** 900mm
- H** 1000mm
- I** 1200mm
- J** 1300mm
- K** 1400mm
- L** 1500mm
- M** 1800mm
- N** 2000mm
- O** 2300mm
- P** 2500mm
- Q** 2800mm
- R** 3000mm

LED COLOUR

- BN** 4000K
- BC** 3000K
- CC** 2700K

POWER

- 0+** 12W/m 1000Lm/m 300LED/m S2216 CRI>90
- P+** 14.4W/m 1100Lm/m 180LED/m S2216 CRI>90



\*Energy class referring to light source

Code example:

QU + 1000mm + 3000K + 12W/m CRI>90 = Code: Q1.HBC0+

## ACCESSORIES TO BE ORDERED SEPARATELY

BASIC CODES

**NM.**

WIDTH

**L10** 10 mm



Magnetic adhesive tape for anodised aluminium profiles.  
Supplied on a 10-metre reel, 1.2 mm thickness.  
**(Force of attraction >40g/cm<sup>2</sup>.)**

BASIC CODES

**4965.**

WIDTH

**08** 8 mm

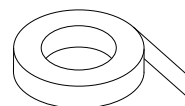

Double-sided adhesive tape for aluminium profiles and LED strips.  
Supplied on a 50-metre reel.

# H1

## H1.

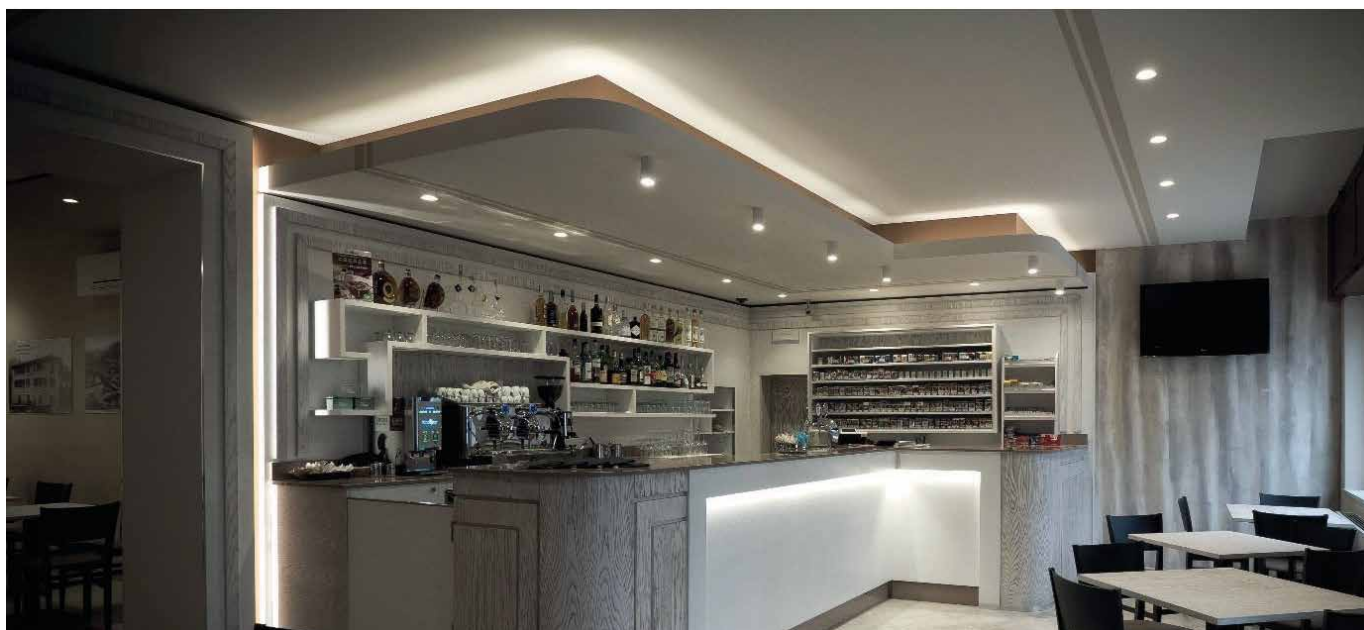

Decorated anodised aluminium lamp complete with press-fit brushed diffuser, side supports and LED source with a high Lumen/Watt ratio. Suitable for furnishing lighting and general lighting.  
Mounting with concealed clips or magnets.

Constant 24Vdc voltage supply  
Parallel connection, 50 cm cable

Constant voltage power supplies page 237  
Dimming Accessories page 249

 **MADE IN ITALY**

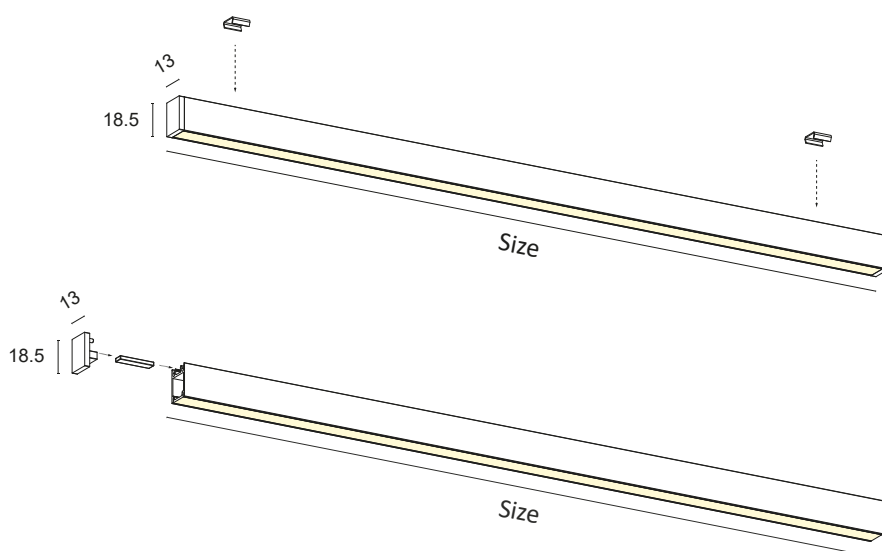
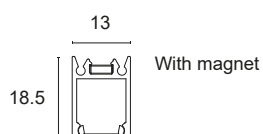
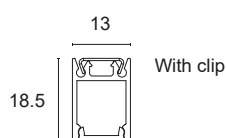
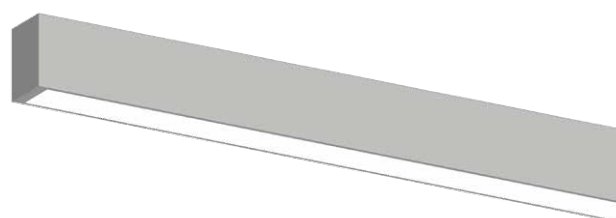

BASIC CODES

**H1.**

FINISHES

- **1** White
  - **2** Matt black
  - ▒ **7** Brushed aluminium
- \*Other finishes on request.

SIDE SUPPORTS

- **1** White
- **2** Matt black
- ▒ **7** Brushed aluminium

SIZE

- A** 300mm
- B** 450mm
- C** 500mm
- D** 600mm
- E** 700mm
- F** 800mm
- G** 900mm
- H** 1000mm
- I** 1200mm
- J** 1300mm
- K** 1400mm
- L** 1500mm
- M** 1800mm
- N** 2000mm
- O** 2300mm
- P** 2500mm
- Q** 2800mm
- R** 3000mm

LED COLOUR

- **BN** 4000K
  - **BC** 3000K
  - **CC** 2700K
- \*Strip also available coloured, Dynamic White, RGB.

POWER

<b>D</b>	10W/m	1400Lm/m	98LED/m	S2835	CRI>85	
<b>D+</b>	10W/m	1600Lm/m	112LED/m	S2835	CRI>90	
<b>E</b>	16.8W/m	2000Lm/m	140LED/m	S2835	CRI>85	
<b>E+</b>	16.8W/m	2000Lm/m	140LED/m	S2835	CRI>90	
<b>F</b>	20.2W/m	2500Lm/m	168LED/m	S2835	CRI>85	
<b>F+</b>	20.2W/m	2500Lm/m	168LED/m	S2835	CRI>90	
<b>O+</b>	12W/m	1000Lm/m	300LED/m	S2216	CRI>90	
<b>P+</b>	14.4W/m	1100Lm/m	180LED/m	S2216	CRI>90	
<b>C2+</b>	15W/m	1550Lm/m	COB LED		CRI>90	

\*Energy class referring to light source

DIFFUSER

- S** BRUSHED

Code example:

H1 + White + Side supports white + H1 + 1000mm + 3000K + 10W//m CRI>85 + Brushed diffuser = Code: H1.11HBCDS

## ACCESSORIES TO BE ORDERED SEPARATELY

BASIC CODES

**PA.GG02**

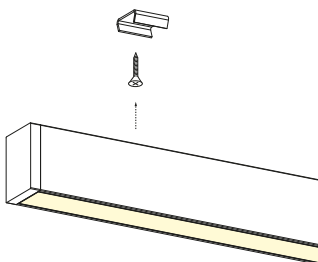

Steel clip for snapping onto flat surfaces. The clip hooks onto the rear slots, which will be perfectly adhered to the surface. 12xM2.5 screws included.

NB. We recommend No. 1 Clip per 500mm

BASIC CODES

**NDL40XP5X2**

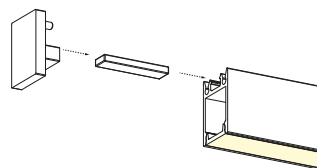

Magnets to glue on for fixing on smooth metal surfaces.

NB. We recommend No. 1 magnet every 150mm (Max. attraction force 1.60kg).

# H2

## H2.



Decorated anodised aluminium lamp complete with press-fit brushed diffuser, side supports and LED source with a high Lumen/Watt ratio. Suitable for furnishing lighting and general lighting.  
Mounting with concealed clips or magnets.

Constant 24Vdc voltage supply  
Parallel connection, 50 cm cable

Constant voltage power supplies page 237

Dimming Accessories page 249

 **MADE IN ITALY**

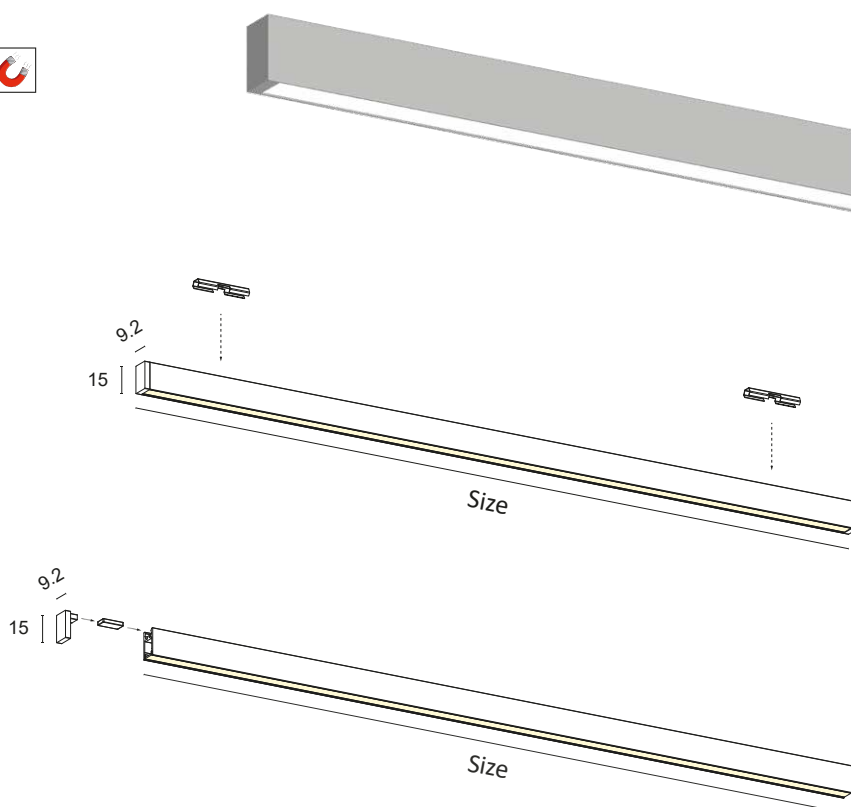
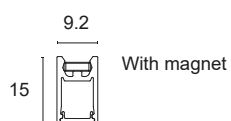
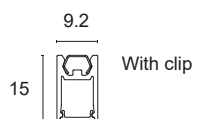

BASIC CODES

**H2.**

FINISHES

- 1** White
  - 2** Matt black
  - 7** Brushed aluminium
- \*Other finishes on request.

SIDE SUPPORTS

- 1** White
- 2** Matt black
- 7** Brushed aluminium

SIZE

- A** 300mm
- B** 450mm
- C** 500mm
- D** 600mm
- E** 700mm
- F** 800mm
- G** 900mm
- H** 1000mm
- I** 1200mm
- J** 1300mm
- K** 1400mm
- L** 1500mm
- M** 1800mm
- N** 2000mm
- O** 2300mm
- P** 2500mm
- Q** 2800mm
- R** 3000mm

LED COLOUR

- BN** 4000K
  - BC** 3000K
  - CC** 2700K
- \*Strip also available coloured, Dynamic White, RGB.

POWER

- N+** 9.6W/m 800Lm/m 120LED/m S2216 CRI>90 
- O+** 12W/m 1000Lm/m 300LED/m S2216 CRI>90 
- P+** 14.4W/m 1100Lm/m 180LED/m S2216 CRI>90 

\*Energy class referring to light source

DIFFUSER

- S** BRUSHED

Code example:

H2 + White + Side supports white + H2 + 1000mm + 3000K + 12W/m CRI>90 + Brushed diffuser = Code: H2.11HBC0+S

**ACCESSORIES TO BE ORDERED SEPARATELY**

BASIC CODES

**PA.GG10**

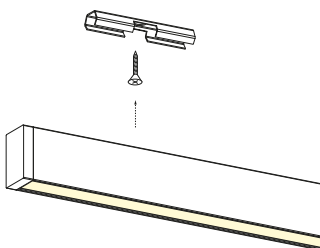

Steel clip for snapping onto flat surfaces. The clip hooks onto the rear slots, which will be perfectly adhered to the surface. 12xM2.5 screws included.

NB. We recommend No. 1 Clip per 500mm

BASIC CODES

**NDL12XP6X2**

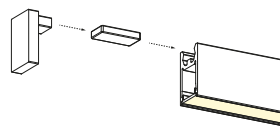

Magnets to glue on for fixing on smooth metal surfaces.

NB. We recommend No. 1 magnet every 150mm (Max. attraction force 0.880kg).



# H3

## H3.

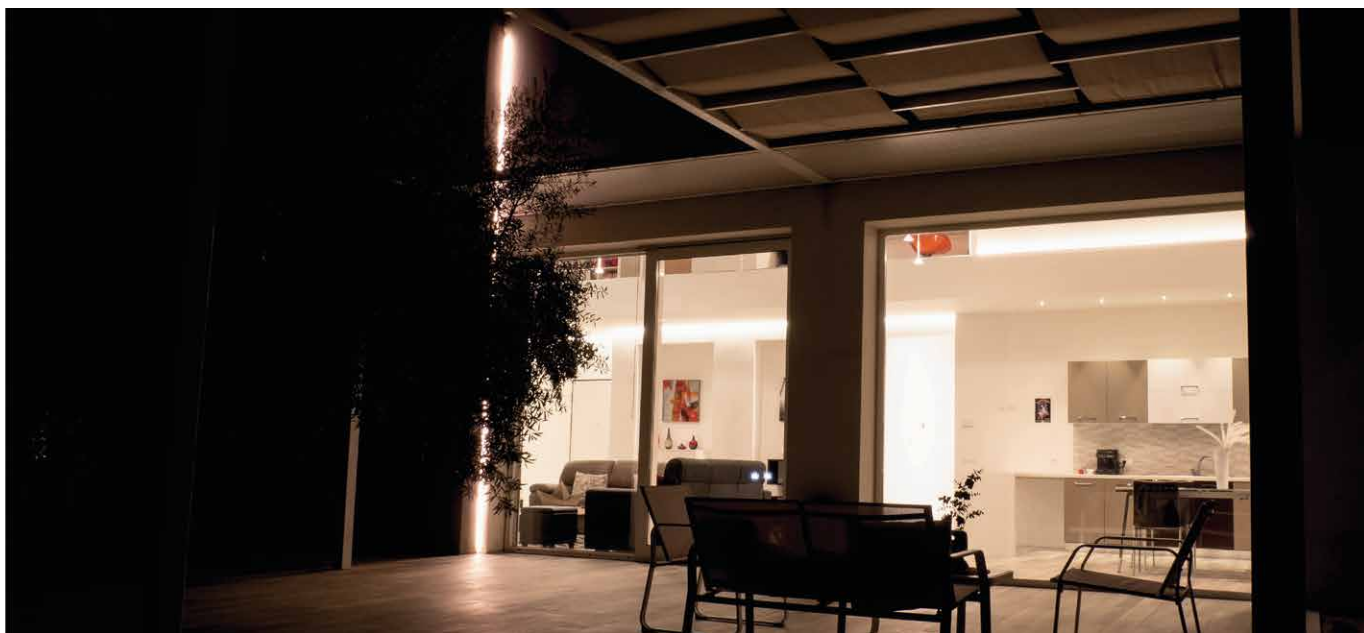

Decorated anodised aluminium lamp complete with press-fit brushed diffuser, side supports and LED source with a high Lumen/Watt ratio. Suitable for furnishing lighting and general lighting.  
Mounting with magnets, included in the package.

Constant 24Vdc voltage supply  
Parallel connection, 50 cm cable

Constant voltage power supplies page 237

Dimming Accessories page 249

 **MADE IN ITALY**

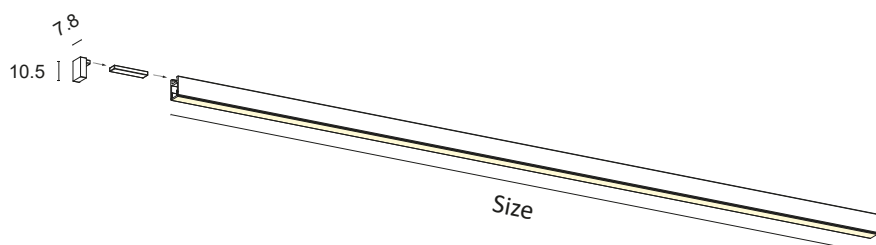
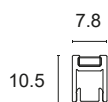
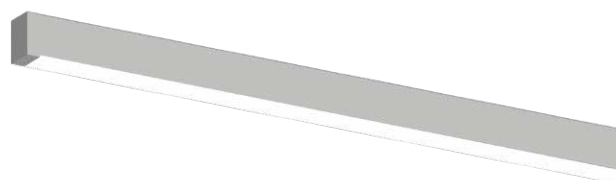

BASIC CODES

**H3.**

FINISHES

- 1** White
  - 2** Matt black
  - 7** Brushed aluminium
- \*Other finishes on request.

SIDE SUPPORTS

- 1** White
- 2** Matt black
- 7** Brushed aluminium

SIZE

- A** 300mm
- B** 450mm
- C** 500mm
- D** 600mm
- E** 700mm
- F** 800mm
- G** 900mm
- H** 1000mm
- I** 1200mm
- J** 1300mm
- K** 1400mm
- L** 1500mm
- M** 1800mm
- N** 2000mm
- O** 2300mm
- P** 2500mm
- Q** 2800mm
- R** 3000mm

LED COLOUR

- BN** 4000K
- BC** 3000K
- CC** 2700K

POWER

- N+** 9.6W/m    800Lm/m 120LED/m S2216 CRI>90 
- O+** 12W/m    1000Lm/m 300LED/m S2216 CRI>90 
- P+** 14.4W/m    1100Lm/m 180LED/m S2216 CRI>90 

\*Energy class referring to light source

DIFFUSER

- S** BRUSHED

**Code example:**

H3 + White + Side supports white + H2 + 1000mm + 3000K + 12W/m CRI>90 + Brushed diffuser = Code: H3.11HBCO+S

# C1

## C1.



Decorated anodised aluminium lamp complete with press-fit brushed diffuser, side supports and LED source with high Lumen/Watt ratio. Possibility of integrating an on/off Touch system into the edge. Suitable for furnishing lighting and general lighting.

Constant 24Vdc voltage supply  
Parallel connection, 50 cm cable

Constant voltage power supplies page 237  
Dimming Accessories page 249

 **MADE IN ITALY**

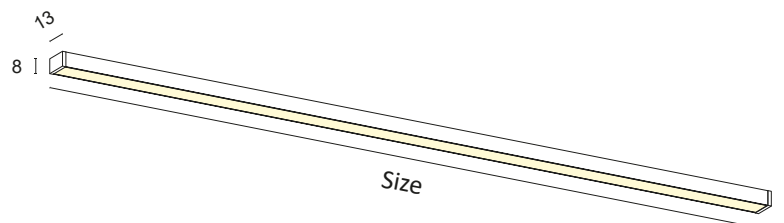
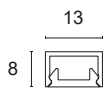
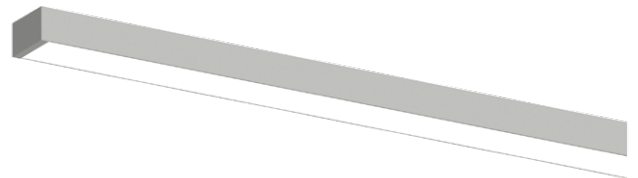

**BASIC CODES**

**C1.**

**FINISHES**

- 1** White
  - 2** Matt black
  - 7** Brushed aluminium
- \*Other finishes on request.

**SIDE SUPPORTS**

- 1** White
- 2** Matt black
- 7** Brushed aluminium

**SIDE SUPPORTS + TOUCH**

- 1T** White
- 2T** Matt black
- 7T** Brushed aluminium





**SIZE**

- A** 300mm
- B** 450mm
- C** 500mm
- D** 600mm
- E** 700mm
- F** 800mm
- G** 900mm
- H** 1000mm
- I** 1200mm
- J** 1300mm
- K** 1400mm
- L** 1500mm
- M** 1800mm
- N** 2000mm
- O** 2300mm
- P** 2500mm
- Q** 2800mm
- R** 3000mm

**LED COLOUR**

- BN** 4000K
  - BC** 3000K
  - CC** 2700K
- \*Strip also available coloured, Dynamic White, RGB.

**POWER**

- E** 16.8W/m 2000Lm/m 140LED/m S2835 CRI>85 
- E+** 16.8W/m 2000Lm/m 140LED/m S2835 CRI>90 
- O+** 12W/m 1000Lm/m 300LED/m S2216 CRI>90 
- P+** 14.4W/m 1100Lm/m 180LED/m S2216 CRI>90 
- C1+** 10W/m 1050Lm/m COB LED CRI>90 

\*Energy class referring to light source

**DIFFUSER**

- S** BRUSHED

**Code example:**

C1 + White + Side supports white + 1000mm + 3000K + 16.8W/m CRI>85 + Satin diffuser = Code: C1.11HBCES

**ACCESSORIES TO BE ORDERED SEPARATELY**

**BASIC CODES**

**NM.**

**WIDTH**

**L10** 10 mm



Magnetic adhesive tape for anodised aluminium profiles.  
Supplied on a 10-metre reel, 1.2 mm thickness.  
**(Force of attraction >40g/cm<sup>2</sup>.)**

**BASIC CODES**

**4965.**

**WIDTH**

**08** 8 mm

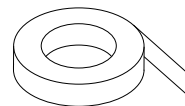

Double-sided adhesive tape for aluminium profiles and LED strips.  
Supplied on a 50-metre reel.

# C2

## C2.



Decorated anodised aluminium lamp complete with press-fit brushed diffuser, side supports and LED source with high Lumen/Watt ratio. Possibility of integrating an on/off Touch system into the edge. Suitable for furnishing lighting and general lighting.

Constant 24Vdc voltage supply  
Parallel connection, 50 cm cable

Constant voltage power supplies page 237  
Dimming Accessories page 249

 **MADE IN ITALY**

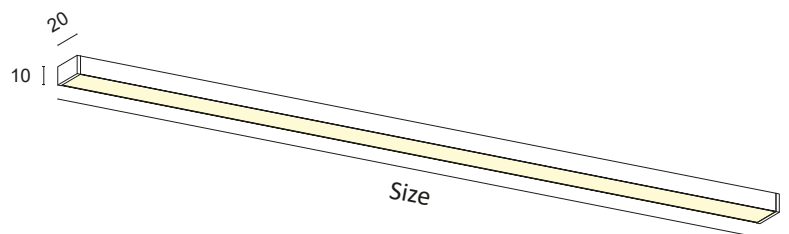
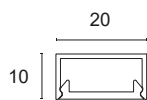
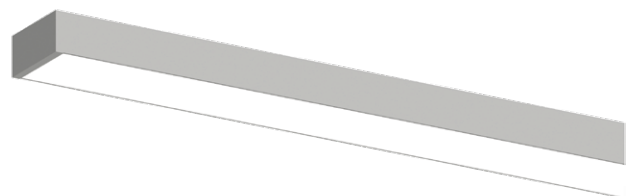



BASIC CODES

**C2.**

FINISHES

- 1** White
  - 2** Matt black
  - 7** Brushed aluminium
- \*Other finishes on request.

SIDE SUPPORTS

- 1** White
- 2** Matt black
- 7** Brushed aluminium

SIDE SUPPORTS + TOUCH

- 1T** White
- 2T** Matt black
- 7T** Brushed aluminium

SIZE

- A** 300mm
- B** 450mm
- C** 500mm
- D** 600mm
- E** 700mm
- F** 800mm
- G** 900mm
- H** 1000mm
- I** 1200mm
- J** 1300mm
- K** 1400mm
- L** 1500mm
- M** 1800mm
- N** 2000mm
- O** 2300mm
- P** 2500mm
- Q** 2800mm
- R** 3000mm

LED COLOUR

- BN** 4000K
  - BC** 3000K
  - CC** 2700K
- \*Strip also available coloured, Dynamic White, RGB.

POWER

- E** 16.8W/m 2000Lm/m 140LED/m S2835 CRI>85 
- E+** 16.8W/m 2000Lm/m 140LED/m S2835 CRI>90 
- F** 20.2W/m 2500Lm/m 168LED/m S2835 CRI>85 
- F+** 20.2W/m 2500Lm/m 168LED/m S2835 CRI>90 
- G** 25W/m 3500Lm/m 160LED/m S2835 CRI>80 
- L+** 28W/m 3500Lm/m 160LED/m S2835 CRI>90 
- C2+** 15W/m 1550Lm/m COB LED CRI>90 

\*Energy class referring to light source

DIFFUSER

- S** BRUSHED

Code example:

C2 + White + Side supports white + C2 + 1000mm + 3000K + 16.8 W/m CRI>85 + Brushed diffuser = Code: C2.11HBCES

## ACCESSORIES TO BE ORDERED SEPARATELY

BASIC CODES

**NM.**

WIDTH

**L20** 20 mm



Magnetic adhesive tape for anodised aluminium profiles.  
Supplied on a 10-metre reel, 1.2 mm thickness.  
(Force of attraction >40g/cm<sup>2</sup>.)

BASIC CODES

**4965.**

WIDTH

**16** 16 mm

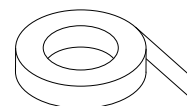

Double-sided adhesive tape for aluminium profiles and LED strips.  
Supplied on a 50-metre reel.

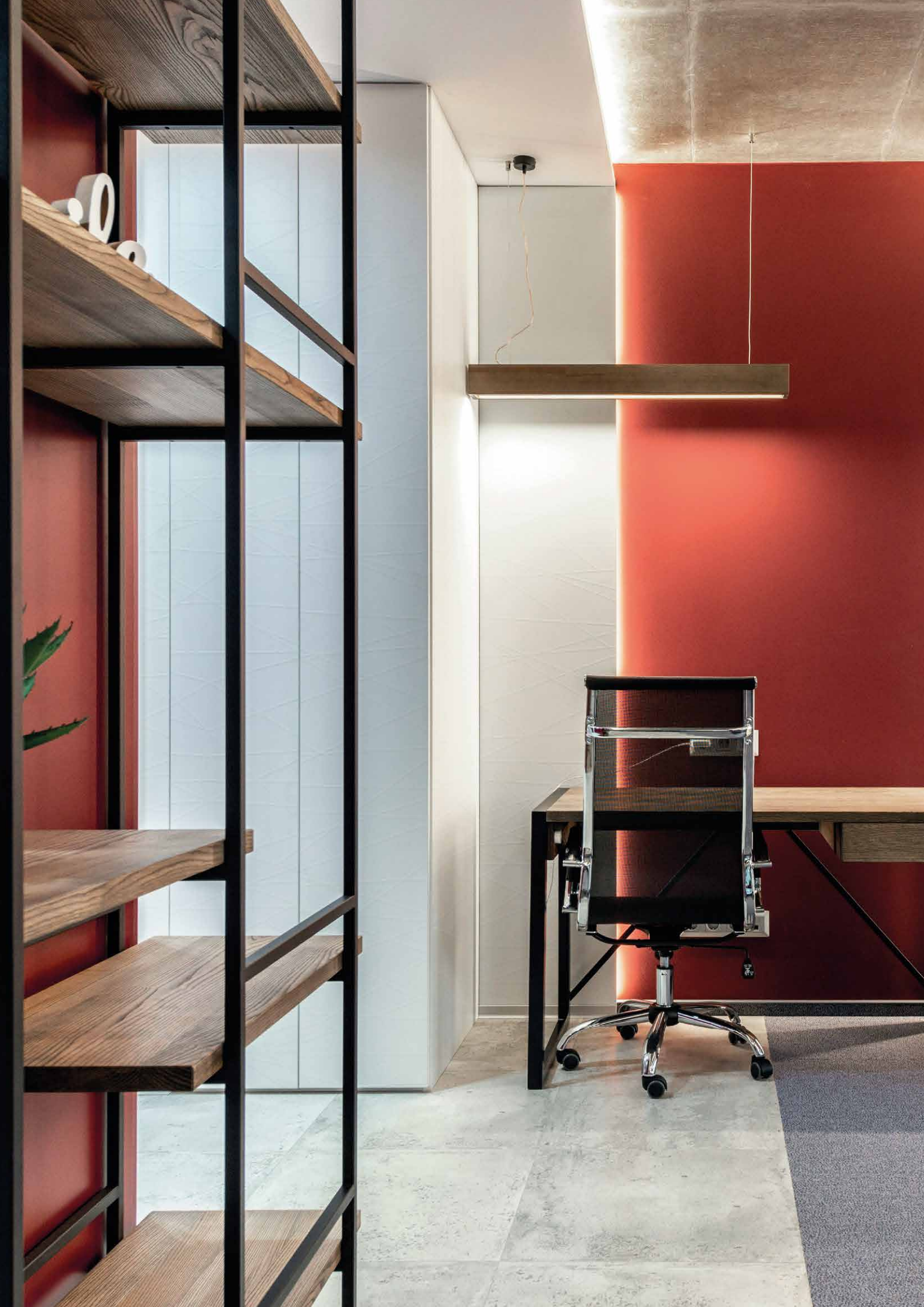

## LINEAR SUSPENSION SYSTEMS

JEY SUSPENSION .....	184
MAGNETIC JEY SUSPENSION .....	186
RHO SUSPENSION .....	188
DELTA SUSPENSION .....	190
KAPPA SUSPENSION .....	192
MAGNETIC KAPPA SUSPENSION .....	194

# JEY SUSPENSION

J3.



Decorated, anodised aluminium suspension light complete with brushed diffuser and high-brightness LED source with a high Lumen/Watt ratio and CRI>90. Suitable as technical decorative lighting for residential, commercial, office, retail and general lighting. Minimalist line, 'full light' diffusion. Suspension mounting with steel ropes and plugs with concealed screws; decentralised ceiling rose, 3000 mm cable, choice of finish.

Constant 24Vdc voltage supply

Power supply included and integrated

 **MADE IN ITALY**

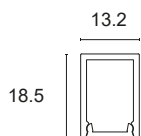
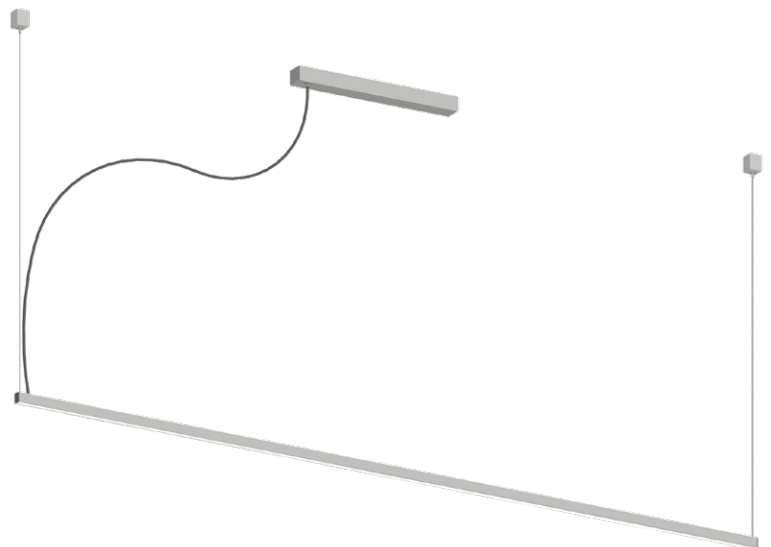

Profile section

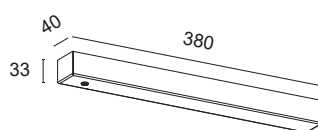

Ceiling rose size

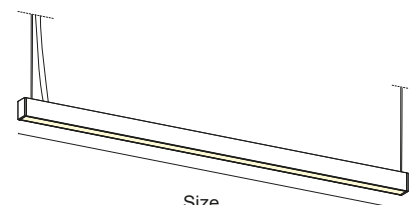

Size

BASIC CODES

**J3.**

FINISHES

- 1** White
- 2** Matt black
- 7** Brushed aluminium
- 8** Gold leaf
- 9** Bond Copper

\*Other finishes on request.

CABLE

- T** Transparent
- B** White
- N** Black

SIZE

- G** 900mm
- H** 1000mm
- I** 1200mm
- J** 1300mm
- K** 1400mm
- L** 1500mm
- M** 1800mm
- N** 2000mm
- O** 2300mm
- P** 2500mm
- Q** 2800mm
- R** 3000mm

LED COLOUR

- BN** 4000K
- BC** 3000K
- CC** 2700K

\*Strip also available coloured, Dynamic White, RGB.

POWER

**E+** 16.8W/m 2000Lm/m 140LED/m S2835 CRI>90

**F+** 20.2W/m 2500Lm/m 168LED/m S2835 CRI>90

**L+** 28W/m 3500Lm/m 160LED/m S2835 CRI>90

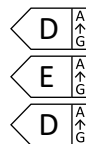

\*Energy class referring to light source

DIFFUSER

**S** BRUSHED

POWER SUPPLY

**N** ON/OFF

**D** DALI + PUSH

**Code example:**

SUSPENSION JEY + White + Black cable + 900mm + 3000K + 28W/m CRI>90 + brushed diffuser + ON/OFF = Code: J3.1NGBCL+SN



# MAGNETIC JEY SUSPENSION

J4.



Decorated, anodised aluminium suspension light complete with brushed diffuser and high-brightness LED source with a high Lumen/Watt ratio and CRI>90. Suitable as technical decorative lighting for residential, commercial, office, retail and general lighting. Minimalist line, 'full light' diffusion.

Suspension mounting with central magnetic ceiling rose, steel ropes and concealed screws; 3000 mm cable, choice of finish.

Constant 24Vdc voltage supply

Power supply included and integrated

 **MADE IN ITALY**

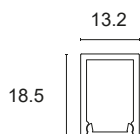
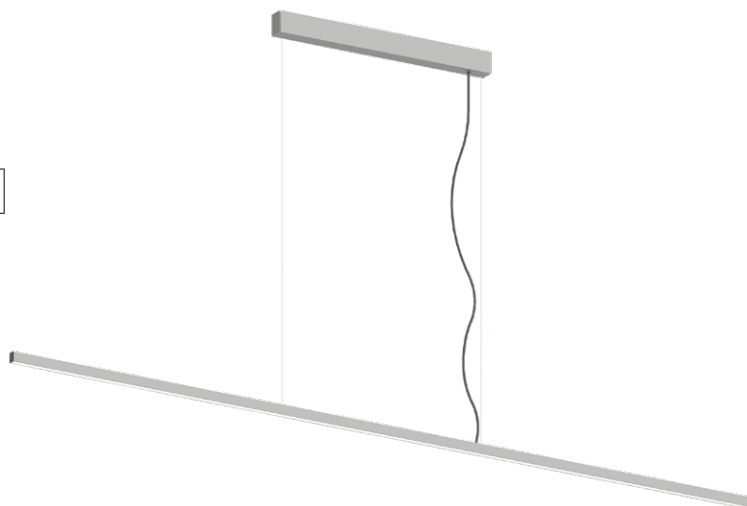

Profile section

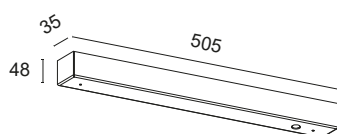

Ceiling rose size

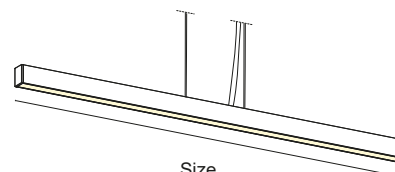

Size

BASIC CODES

**J4.**

FINISHES

- 1** White
- 2** Matt black
- 7** Brushed aluminium
- 8** Gold leaf
- 9** Bond Copper

\*Other finishes on request.

CABLE

- T** Transparent
- B** White
- N** Black

SIZE

- G** 900mm
- H** 1000mm
- I** 1200mm
- J** 1300mm
- K** 1400mm
- L** 1500mm
- M** 1800mm
- N** 2000mm
- O** 2300mm
- P** 2500mm
- Q** 2800mm
- R** 3000mm

LED COLOUR

- BN** 4000K
- BC** 3000K
- CC** 2700K

\*Strip also available coloured, Dynamic White, RGB.

POWER

**E+** 16.8W/m 2000Lm/m 140LED/m S2835 CRI>90

**F+** 20.2W/m 2500Lm/m 168LED/m S2835 CRI>90

**L+** 28W/m 3500Lm/m 160LED/m S2835 CRI>90

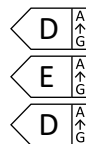

\*Energy class referring to light source

DIFFUSER

**S** BRUSHED

POWER SUPPLY

**N** ON/OFF

**D** DALI + PUSH

**Code example:**

SUSPENSION JEY MAGNETIC + White + Black cable + 900mm + 3000K + 28W/m CRI>90 + brushed diffuser + ON/OFF = Code: J4.1NGBCL+SN

# RHO SUSPENSION

R2.



Decorated, anodised aluminium suspension light complete with brushed or microprismatic diffuser and high-brightness LED source with a high Lumen/Watt ratio and CRI>90. Suitable as technical decorative lighting for residential, commercial, office, retail and general lighting. Minimalist line, 'full light' diffusion. Suspension mounting with steel ropes and plugs with concealed screws; decentralised ceiling rose, 3000 mm cable, choice of finish.

Constant 24Vdc voltage supply

Power supply included and integrated

 **MADE IN ITALY**

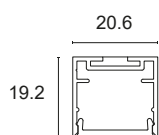
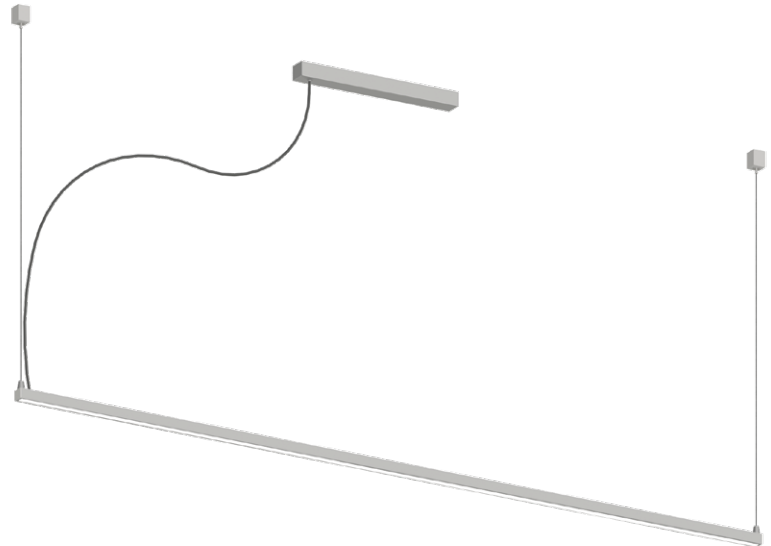

Profile section

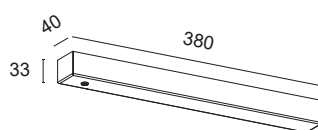

Ceiling rose size

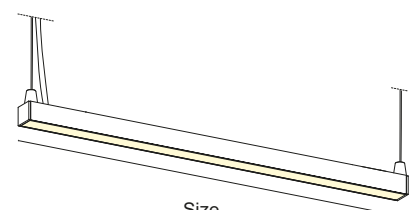

Size

BASIC CODES

**R2.**

FINISHES

- 1** White
- 2** Matt black
- 7** Brushed aluminium
- 8** Gold leaf
- 9** Bond Copper

\*Other finishes on request.

CABLE

- T** Transparent
- B** White
- N** Black

SIZE

- G** 900mm
- H** 1000mm
- I** 1200mm
- J** 1300mm
- K** 1400mm
- L** 1500mm
- M** 1800mm
- N** 2000mm
- O** 2300mm
- P** 2500mm
- Q** 2800mm
- R** 3000mm

LED COLOUR

- BN** 4000K
- BC** 3000K
- CC** 2700K

\*Strip also available coloured, Dynamic White, RGB and RGBW.

POWER

**E+** 16.8W/m 2000Lm/m 140LED/m S2835 CRI>90

**F+** 20.2W/m 2500Lm/m 168LED/m S2835 CRI>90

**L+** 28W/m 3500Lm/m 160LED/m S2835 CRI>90



\*Energy class referring to light source

DIFFUSER

- M** MICROPRISMATIC
- S** BRUSHED

POWER SUPPLY

- N** ON/OFF
- D** DALI + PUSH

Code example:

RHO SUSPENSION + White + Black cable + 900mm + 3000K + 28W/m CRI>90 + brushed diffuser + ON/OFF = Code: R2.1NGBCL+SN

# DELTA SUSPENSION

D2.



Decorated, anodised aluminium suspension light complete with brushed or microprismatic diffuser and high-brightness LED source with a high Lumen/Watt ratio and CRI>90. Suitable as primary technical decorative lighting for residential, commercial, office, retail and general lighting. 'Full light' diffusion. Suspension mounting with steel ropes and plugs with concealed screws; decentralised ceiling rose, 3000 mm cable, choice of finish.

Constant 24Vdc voltage supply

Power supply included and integrated

 **MADE IN ITALY**

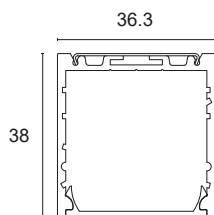
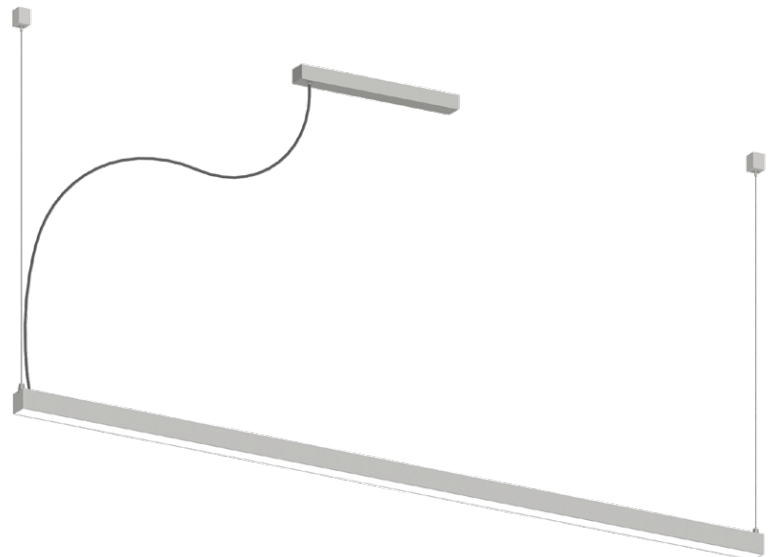

Profile section

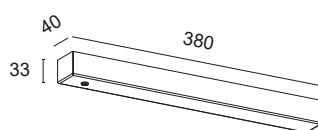

Ceiling rose size

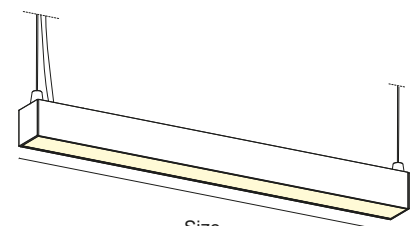

Size



**BASIC CODES**

**D2.**

**FINISHES**

- 1** White
- 2** Matt black
- 7** Brushed aluminium
- 8** Gold leaf
- 9** Bond Copper

\*Other finishes on request.

**CABLE**

- T** Transparent
- B** White
- N** Black

**SIZE**

- G** 900mm
- H** 1000mm
- I** 1200mm
- J** 1300mm
- K** 1400mm
- L** 1500mm
- M** 1800mm
- N** 2000mm
- O** 2300mm
- P** 2500mm
- Q** 2800mm
- R** 3000mm

**LED COLOUR**

- BN** 4000K
- BC** 3000K
- CC** 2700K

\*Strip also available coloured, Dynamic White, RGB and RGBW.

**POWER**

**F+** 20.2W/m 2500Lm/m 168LED/m S2835 CRI>90

**L+** 28W/m 3500Lm/m 160LED/m S2835 CRI>90

**M+** 40W/m 5000Lm/m 480LED/m S2835 CRI>90

\*Energy class referring to light source

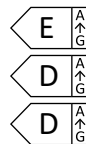

**DIFFUSER**

**M** MICROPRISMATIC

**S** BRUSHED

**POWER SUPPLY**

**N** ON/OFF

**D** DALI + PUSH

**Code example:**

DELTA SUSPENSION + White + Black cable + 900mm + 3000K + 28W/m CRI>90 + brushed diffuser + ON/OFF = Code: D2.1NGBCL+SN

## COMPLEMENTARY SYSTEMS

**EXAMPLE OF DELTA SUSPENSION AND REM PROJECTOR**

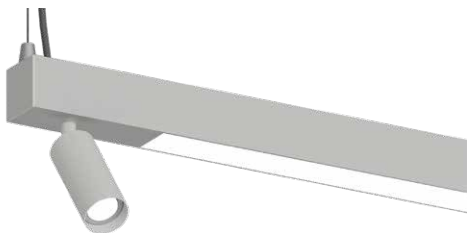

\*Details on p. 276

**EXAMPLE OF DELTA SUSPENSION AND DARK MODULE**

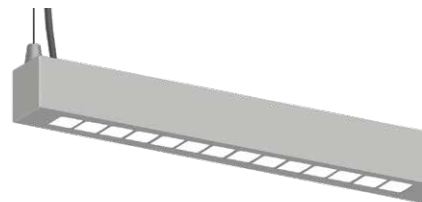

\*Details on p. 276

**EXAMPLE OF DELTA SUSPENSION, REM AND DARK MODULE**

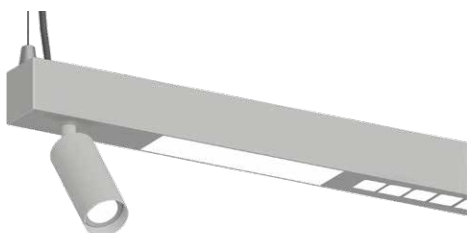

\*Details on p. 276

# KAPPA SUSPENSION

K2.



Decorated, anodised aluminium direct and indirect emission suspension light complete with brushed or microprismatic diffuser and high-brightness LED source with a high Lumen/Watt ratio and CRI>90. Suitable as primary technical decorative lighting for residential, commercial, office, retail and general lighting. 'Full light' diffusion. Suspension mounting with steel ropes and plugs with concealed screws; decentralised ceiling rose, 3000 mm cable, choice of finish.

Constant 24Vdc voltage supply

Power supply included and integrated

 **MADE IN ITALY**

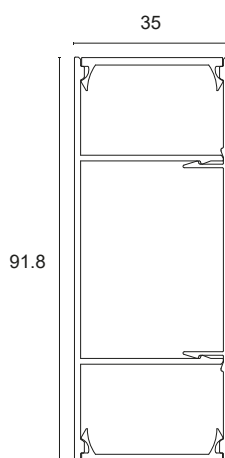

Profile section

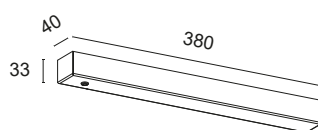
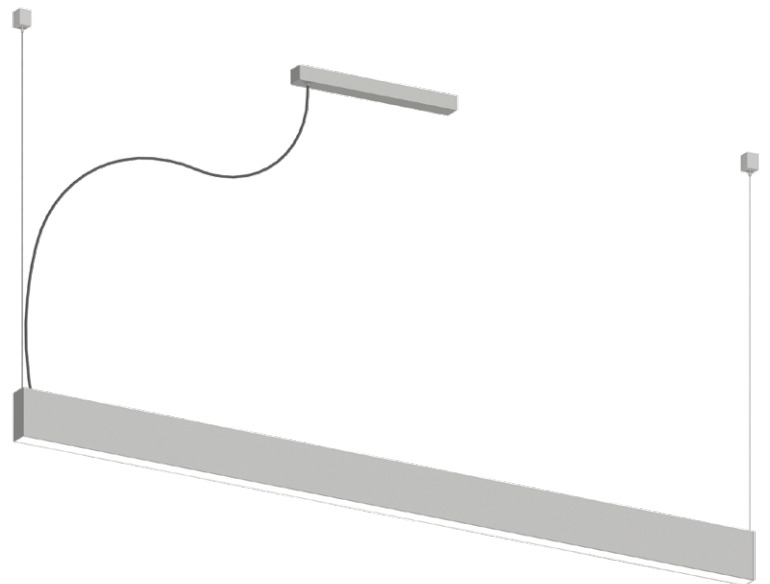

Ceiling rose size

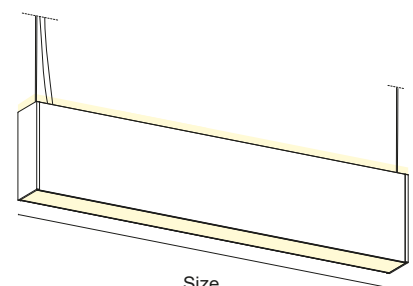

Size

**BASIC CODES**

**K2.**

**FINISHES**

- 1** White
- 2** Matt black
- 7** Brushed aluminium
- 8** Gold leaf
- 9** Bond Copper

\*Other finishes on request.

**CABLE**

- T** Transparent
- B** White
- N** Black

**SIZE**

- G** 900mm
- H** 1000mm
- I** 1200mm
- J** 1300mm
- K** 1400mm
- L** 1500mm
- M** 1800mm
- N** 2000mm
- O** 2300mm
- P** 2500mm
- Q** 2800mm
- R** 3000mm

**LED COLOUR**

- BN** 4000K
- BC** 3000K
- CC** 2700K

\*Strip also available coloured, Dynamic White, RGB and RGBW.

**POWER**

- F+** 20.2W/m 2500Lm/m 168LED/m S2835 CRI>90
- L+** 28W/m 3500Lm/m 160LED/m S2835 CRI>90
- M+** 40W/m 5000Lm/m 480LED/m S2835 CRI>90

\*Energy class referring to light source

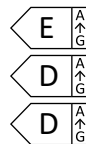

**DIFFUSER**

- M** MICROPRISMATIC
  - S** BRUSHED
- \*Indirect diffuser, brushed.

**POWER SUPPLY**

- N** ON/OFF
  - D** DALI + PUSH
- \*The lamp can be customised with independent switch-on and dimming on request.

**Code example:**

KAPPA SUSPENSION + White + Black cable + 900mm + 3000K + 28W/m CRI>90 + brushed diffuser + ON/OFF = Code: K2.1NGBCL+SN

**COMPLEMENTARY SYSTEMS**

**EXAMPLE OF KAPPA SUSPENSION AND REM PROJECTOR**

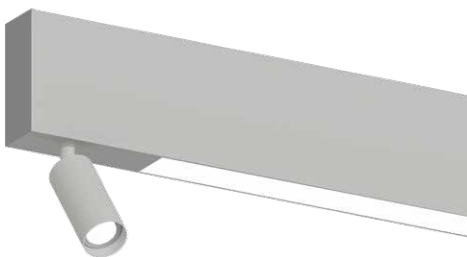

\*Details on p. 276

**EXAMPLE OF KAPPA SUSPENSION AND DARK MODULE**

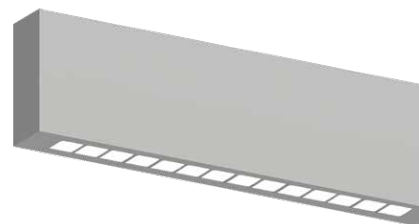

\*Details on p. 276

**EXAMPLE OF KAPPA SUSPENSION, REM AND DARK MODULE**

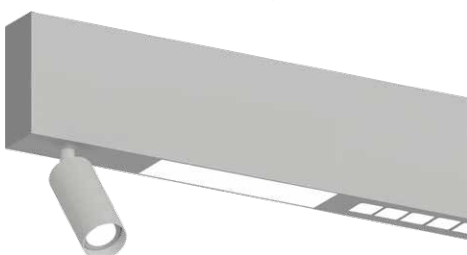

\*Details on p. 276

# MAGNETIC KAPPA SUSPENSION

K4.



Decorated, anodised aluminium direct and indirect emission suspension light complete with brushed or microprismatic diffuser and high-brightness LED source with a high Lumen/Watt ratio and CRI>90. Suitable as primary technical decorative lighting for residential, commercial, office, retail and general lighting. 'Full light' diffusion.

Suspension mounting with central magnetic ceiling rose, steel ropes and concealed screws; 3000 mm cable, choice of finish.

Constant 24Vdc voltage supply

Power supply included and integrated

 **MADE IN ITALY**

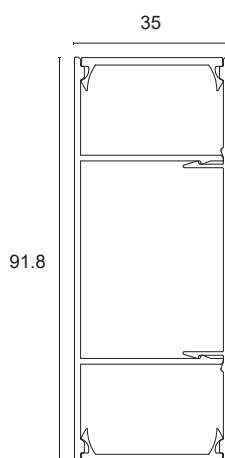

Profile section

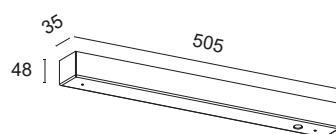
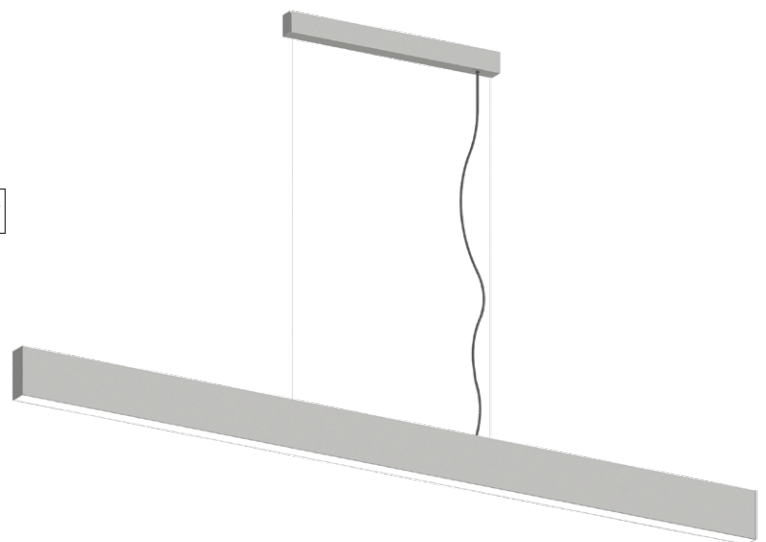

Ceiling rose size

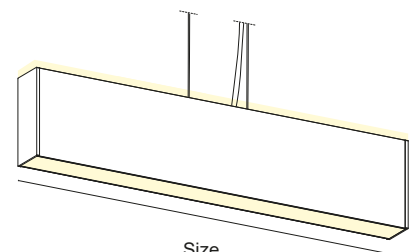

Size

**BASIC CODES**

**K4.**

**FINISHES**

- 1** White
- 2** Matt black
- 7** Brushed aluminium
- 8** Gold leaf
- 9** Bond Copper

\*Other finishes on request.

**CABLE**

- T** Transparent
- B** White
- N** Black

**SIZE**

- G** 900mm
- H** 1000mm
- I** 1200mm
- J** 1300mm
- K** 1400mm
- L** 1500mm
- M** 1800mm
- N** 2000mm
- O** 2300mm
- P** 2500mm
- Q** 2800mm
- R** 3000mm

**LED COLOUR**

- BN** 4000K
- BC** 3000K
- CC** 2700K

\*Strip also available coloured, Dynamic White, RGB and RGBW.

**POWER**

- F+** 20.2W/m 2500Lm/m 168LED/m S2835 CRI>90
- L+** 28W/m 3500Lm/m 160LED/m S2835 CRI>90
- M+** 40W/m 5000Lm/m 480LED/m S2835 CRI>90

\*Energy class referring to light source

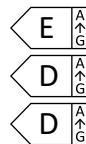

**DIFFUSER**

- M** MICROPRISMATIC
  - S** BRUSHED
- \*Indirect diffuser, brushed.

**POWER SUPPLY**

- N** ON/OFF
  - D** DALI + PUSH
- \*The lamp can be customised with independent switch-on and dimming on request.

**Code example:**

SUSPENSION KAPPA MAGNETIC + White + Black cable + 900mm + 3000K + 28W/m CRI>90 + brushed diffuser + ON/OFF = Code: K4.1NGBCL+SN

**COMPLEMENTARY SYSTEMS**

**EXAMPLE OF KAPPA SUSPENSION AND REM PROJECTOR**

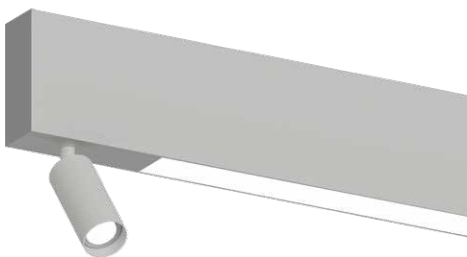

\*Details on p. 276

**EXAMPLE OF KAPPA SUSPENSION AND DARK MODULE**

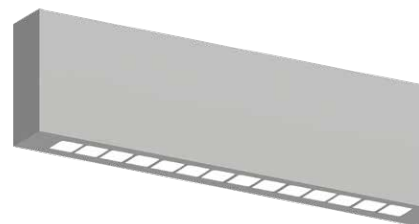

\*Details on p. 276

**EXAMPLE OF KAPPA SUSPENSION, REM AND DARK MODULE**

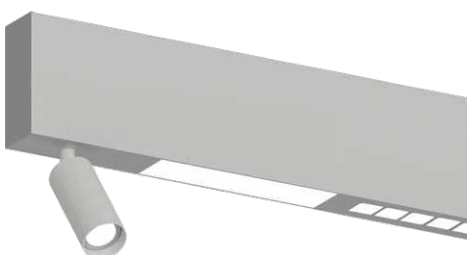

\*Details on p. 276





A built-in wooden shelving unit with a dark wood finish. It features several white shelves and a large open compartment. On the top shelf, there is a black and white photograph of a young child, a small silver sculpture, and a small owl figurine. Below the photo, there is a large open compartment containing a child's sculpture. The unit is mounted on a wall with a light-colored background.



## LINEAR WALL SYSTEMS

KAPPA 1.....	198
JEY 5.....	200

# KAPPA 1

K1.



Decorated anodised dual-emission aluminium lamp complete with brushed or microprismatic diffuser and high-brightness LED source with a high Lumen/Watt ratio. Suitable for primary residential, retail, large-space and general lighting. Wall mounting with concealed brackets.

Constant voltage supply 24Vdc

Power supply included and integrated

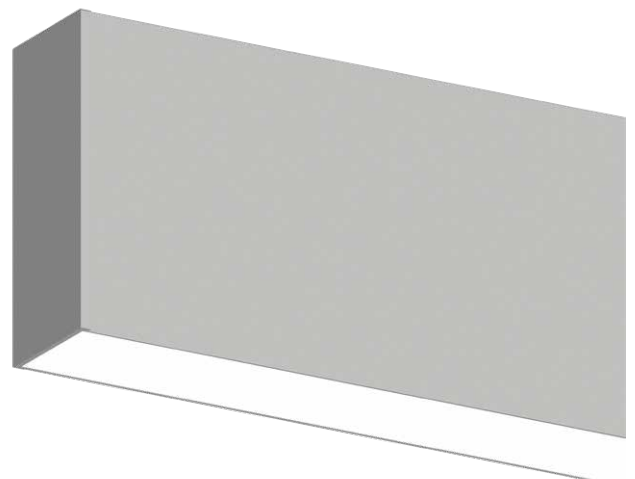

 **MADE IN ITALY**

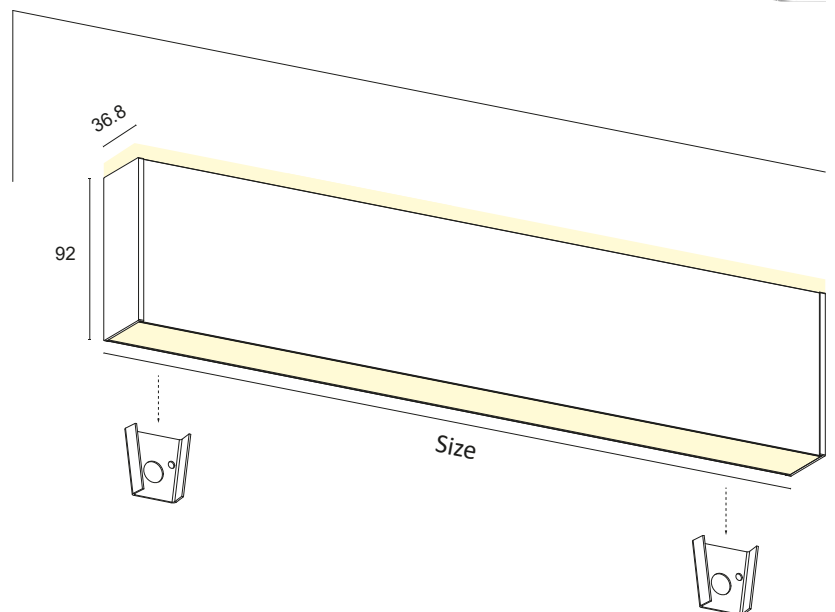
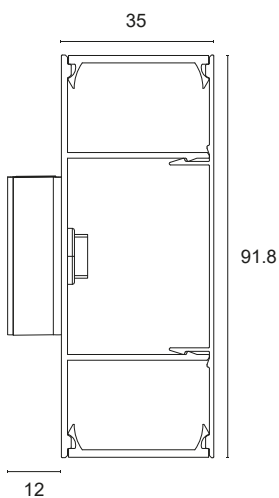

**BASIC CODES**

**K1.**

**FINISHES**

- 1** White
  - 2** Matt black
  - 7** Brushed aluminium
- \*Other finishes on request.

**SIDE SUPPORTS**

- 1** White
- 2** Matt black
- 7** Brushed aluminium

**SIZE**

- A** 300mm
- B** 450mm
- C** 500mm
- D** 600mm
- E** 700mm
- F** 800mm
- G** 900mm
- H** 1000mm
- I** 1200mm
- J** 1300mm
- K** 1400mm
- L** 1500mm
- M** 1800mm
- N** 2000mm
- O** 2300mm
- P** 2500mm
- Q** 2800mm
- R** 3000mm

**LED COLOUR**

- BN** 4000K
  - BC** 3000K
  - CC** 2700K
- \*Strip also available coloured, Dynamic White, RGB and RGBW.

**POWER**

<b>F</b>	20.2W/m	2500Lm/m	168LED/m	S2835	CRI>85	
<b>F+</b>	20.2W/m	2500Lm/m	168LED/m	S2835	CRI>90	
<b>G</b>	25W/m	3500Lm/m	160LED/m	S2835	CRI>80	
<b>L+</b>	28W/m	3500Lm/m	160LED/m	S2835	CRI>90	
<b>H</b>	30W/m	4500Lm/m	240LED/m	S2835	CRI>80	
<b>M+</b>	40W/m	5000Lm/m	480LED/m	S2835	CRI>90	

\*Energy class referring to light source

**DIFFUSER**

- M** MICROPRISMATIC
- S** BRUSHED

**POWER SUPPLY**

- N** ON/OFF
  - D** DALI + PUSH
- \*The lamp can be customised with independent switch-on and dimming on request.

**Code example:**

KAPPA 1 + White + Side supports white + 1000mm + 3000K + 25W/m CRI>80 + Brushed diffuser + ON/OFF = Code: K1.11HBCGSN

## COMPLEMENTARY SYSTEMS

**EXAMPLE OF KAPPA WALL LIGHT AND REM PROJECTOR**

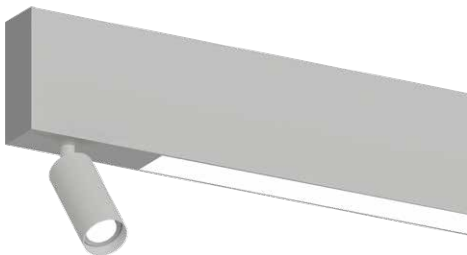

\*Details on p. 276

**EXAMPLE OF KAPPA WALL LIGHT AND DARK MODULE**

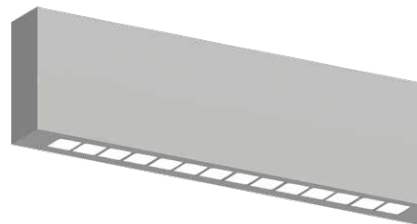

\*Details on p. 276

**EXAMPLE OF KAPPA WALL LIGHT, REM AND DARK MODULE**

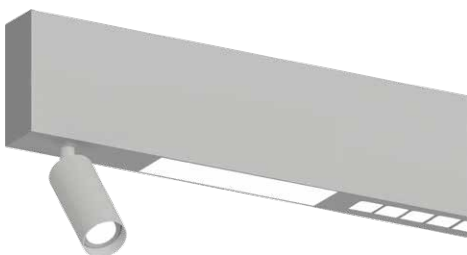

\*Details on p. 276

# JEY 5

J5.



Decorated anodised aluminium lamp complete with brushed diffuser and high-brightness LED source with a high Lumen/Watt ratio. Suitable for decorative, accent, courtesy and general lighting.  
Wall mounting with concealed screws.

Constant 24Vdc voltage supply  
Parallel connection, 50 cm cable

Constant voltage power supplies page 237  
Dimming Accessories page 249

 **MADE IN ITALY**

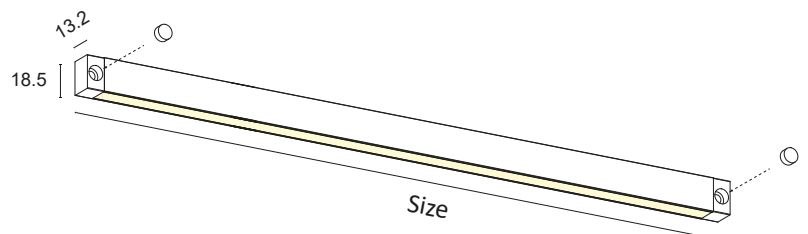
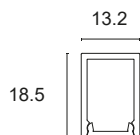
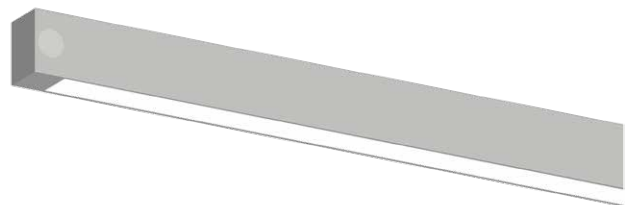



BASIC CODES

**J5.**

FINISHES

- 1** White
  - 2** Matt black
  - 7** Brushed aluminium
- \*Other finishes on request.

SIDE SUPPORTS

- 1** White
- 2** Matt black
- 5** Grey
- 7** Brushed aluminium

SIZE

- C** 500mm
- D** 600mm
- E** 700mm
- F** 800mm
- G** 900mm
- H** 1000mm
- I** 1200mm
- J** 1300mm
- K** 1400mm
- L** 1500mm
- M** 1800mm
- N** 2000mm
- O** 2300mm
- P** 2500mm
- Q** 2800mm
- R** 3000mm

LED COLOUR

- BN** 4000K
  - BC** 3000K
  - CC** 2700K
- \*Strip also available coloured, Dynamic White, RGB.

POWER

<b>D</b>	10W/m	1400Lm/m	98LED/m	S2835	CRI>85	
<b>D+</b>	10W/m	1600Lm/m	112LED/m	S2835	CRI>90	
<b>E</b>	16.8W/m	2000Lm/m	140LED/m	S2835	CRI>85	
<b>E+</b>	16.8W/m	2000Lm/m	140LED/m	S2835	CRI>90	
<b>F</b>	20.2W/m	2500Lm/m	168LED/m	S2835	CRI>85	
<b>F+</b>	20.2W/m	2500Lm/m	168LED/m	S2835	CRI>90	
<b>C1+</b>	10W/m	1050Lm/m	LED COB		CRI>90	

\*Energy class referring to light source

DIFFUSER

- S** BRUSHED

Code example:

JEY 5 + White + Side supports white + 1000mm + 3000K + 10W/m CRI>85 + Brushed diffuser = Code: J5.11HBCDS



## DIRECTIONAL LINEAR SYSTEMS

DIRECTIONAL RHO .....	204
DIRECTIONAL DELTA .....	206

# DIRECTIONAL RHO

R4.



Decorated anodised aluminium lamp complete with satin or microprismatic diffuser and high-brightness LED source with high Lumen/Watt ratio. Suitable for primary residential, retail, large-space and general lighting. Ceiling mounting with directional steel brackets.

Constant voltage supply 24Vdc  
Parallel connection, 50 cm cable

Constant voltage power supplies page 237  
Dimming Accessories page 249

 **MADE IN ITALY**



\*On request IP54 or IP65

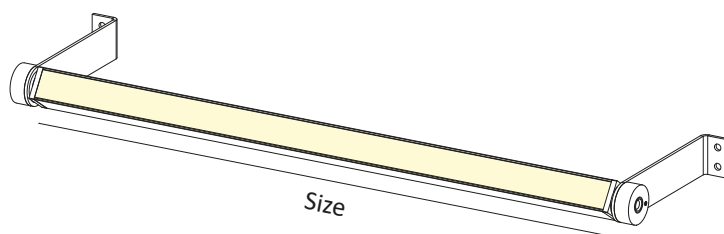
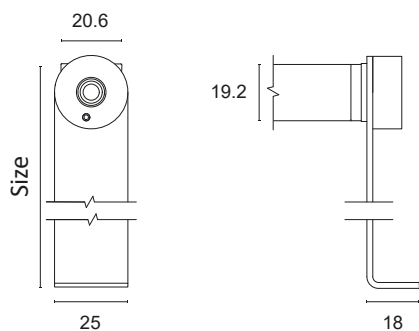
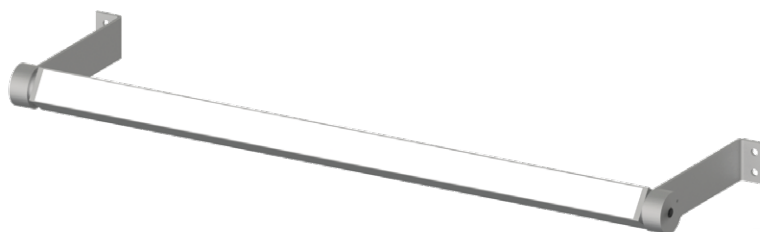

BASIC CODES

**R4.**

FINISHES

- 1** White
  - 2** Matt black
  - 7** Brushed aluminium
- \*Other finishes on request.

BRACKET SIZE

- 1** 50mm
- 2** 100mm
- 3** 200mm

SIZE

- G** 900mm
- H** 1000mm
- I** 1200mm
- J** 1300mm
- K** 1400mm
- L** 1500mm
- M** 1800mm
- N** 2000mm
- O** 2300mm
- P** 2500mm

LED COLOUR

- BN** 4000K
  - BC** 3000K
  - CC** 2700K
- \*Strip also available coloured, Dynamic White, RGB and RGBW.

POWER

IP65	<b>D65</b>	10W/m	1400Lm/m	98LED/m	S2835	CRI>85	
IP54	<b>E54</b>	16.8W/m	2000Lm/m	140LED/m	S2835	CRI>85	
IP54	<b>F54</b>	20.2W/m	2500Lm/m	168LED/m	S2835	CRI>85	
	<b>F</b>	20.2W/m	2500Lm/m	168LED/m	S2835	CRI>85	
	<b>F+</b>	20.2W/m	2500Lm/m	168LED/m	S2835	CRI>90	
	<b>G</b>	25W/m	3500Lm/m	160LED/m	S2835	CRI>80	
	<b>L+</b>	28W/m	3500Lm/m	160LED/m	S2835	CRI>90	
	<b>H</b>	30W/m	4500Lm/m	240LED/m	S2835	CRI>80	

\*Energy class referring to light source

DIFFUSER

- M** MICROPRISMATIC
- S** BRUSHED

Code example:

RHO DIRECTIONAL + White + Bracket 100mm + 1000mm + 3000K + 20.2W/m CRI>85 + Brushed diffuser = Code: R4.12HBCFS



# DIRECTIONAL DELTA

## D4

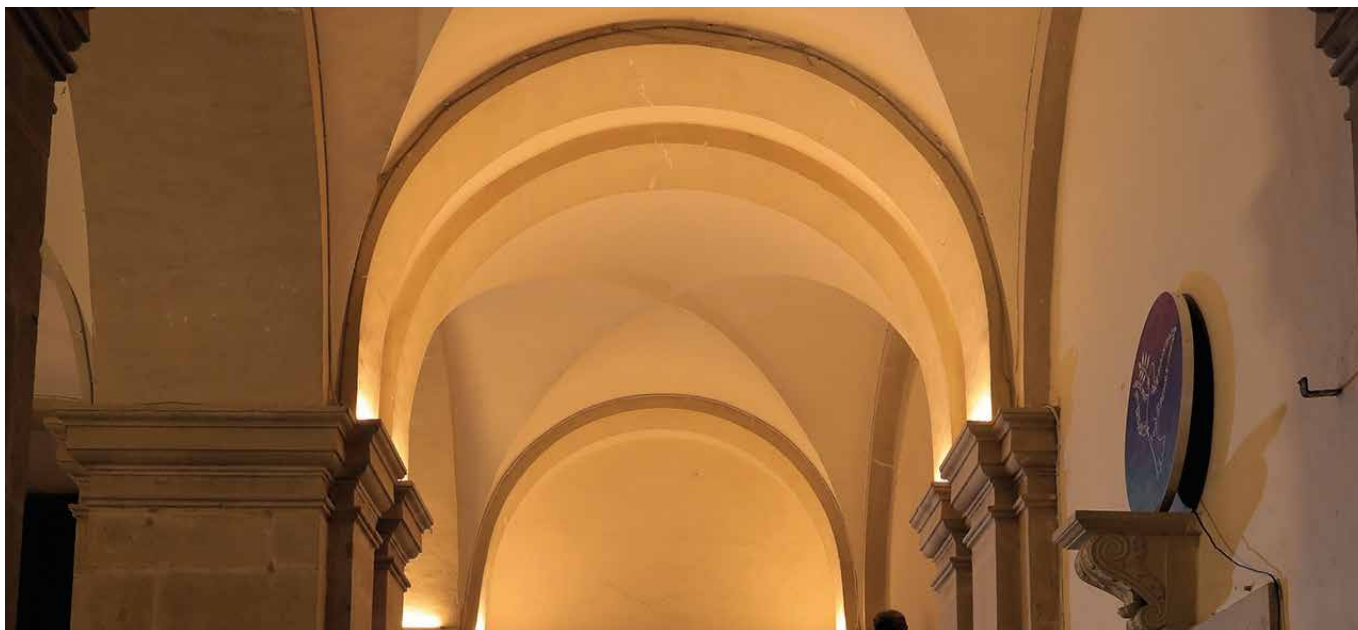

Decorated anodised aluminium lamp complete with satin or microprismatic diffuser and high-brightness LED source with high Lumen/Watt ratio. Suitable for primary residential, retail, large-space and general lighting. Ceiling mounting with directional steel brackets.

Constant voltage supply 24Vdc  
Parallel connection, 50 cm cable

Constant voltage power supplies page 237  
Dimming Accessories page 249

 **MADE IN ITALY**



\*On request IP54 or IP65

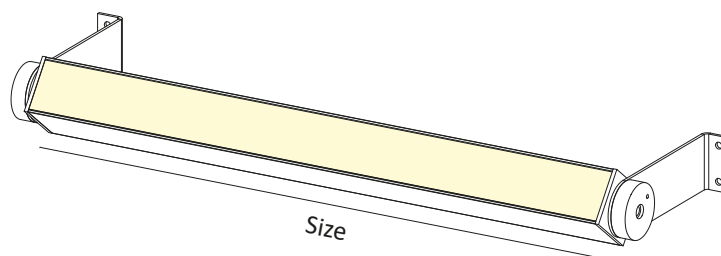
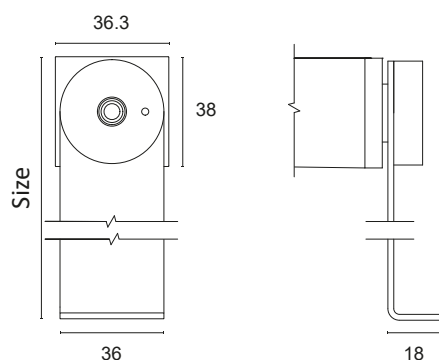
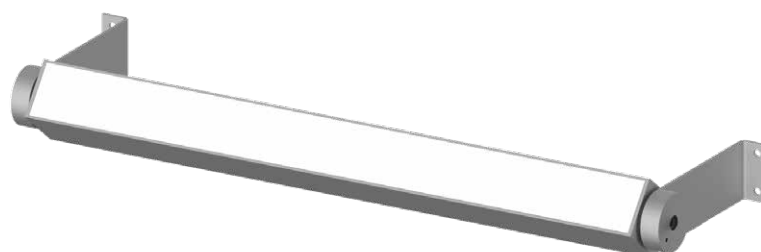

BASIC CODES

**D4.**

FINISHES

- 1** White
  - 2** Matt black
  - 7** Brushed aluminium
- \*Other finishes on request.

BRACKET SIZE

- 1** 50mm
- 2** 100mm
- 3** 200mm

SIZE

- G** 900mm
- H** 1000mm
- I** 1200mm
- J** 1300mm
- K** 1400mm
- L** 1500mm
- M** 1800mm
- N** 2000mm
- O** 2300mm
- P** 2500mm

LED COLOUR

- BN** 4000K
  - BC** 3000K
  - CC** 2700K
- \*Strip also available coloured, Dynamic White, RGB and RGBW.

POWER

IP65	<b>D65</b>	10W/m	1400Lm/m	98LED/m	S2835	CRI>85	
IP54	<b>E54</b>	16.8W/m	2000Lm/m	140LED/m	S2835	CRI>85	
IP54	<b>F54</b>	20.2W/m	2500Lm/m	168LED/m	S2835	CRI>85	
	<b>F</b>	20.2W/m	2500Lm/m	168LED/m	S2835	CRI>85	
	<b>F+</b>	20.2W/m	2500Lm/m	168LED/m	S2835	CRI>90	
	<b>G</b>	25W/m	3500Lm/m	160LED/m	S2835	CRI>80	
	<b>L+</b>	28W/m	3500Lm/m	160LED/m	S2835	CRI>90	
	<b>H</b>	30W/m	4500Lm/m	240LED/m	S2835	CRI>80	

\*Energy class referring to light source

DIFFUSER

- M** MICROPRISMATIC
- S** BRUSHED

Code example:

DELTA DIRECTIONAL + White + Bracket 100mm + 1000mm + 3000K + 20.2W/m CRI>85 + Satin Diffuser = Code: D4.12HBCFS





## FLOOR LINEAR SYSTEM

YPSILON FLOOR LIGHT ..... 210



# YPSILON FLOOR LIGHT

Y3.



Decorated anodised aluminium lamp complete with floor-fitting brushed or transparent diffuser and high-brightness LED source with a high Lumen/Watt ratio. Suitable for primary residential, retail, large-space and general lighting. The interlocking profile mechanism allows for easy maintenance. Flush fitting in plasterboard, brickwork or floor.

Constant voltage supply 24Vdc  
Parallel connection, 50 cm cable

Constant voltage power supplies page 237  
Dimming Accessories page 249

 **MADE IN ITALY**



\*On request IP54 or IP65

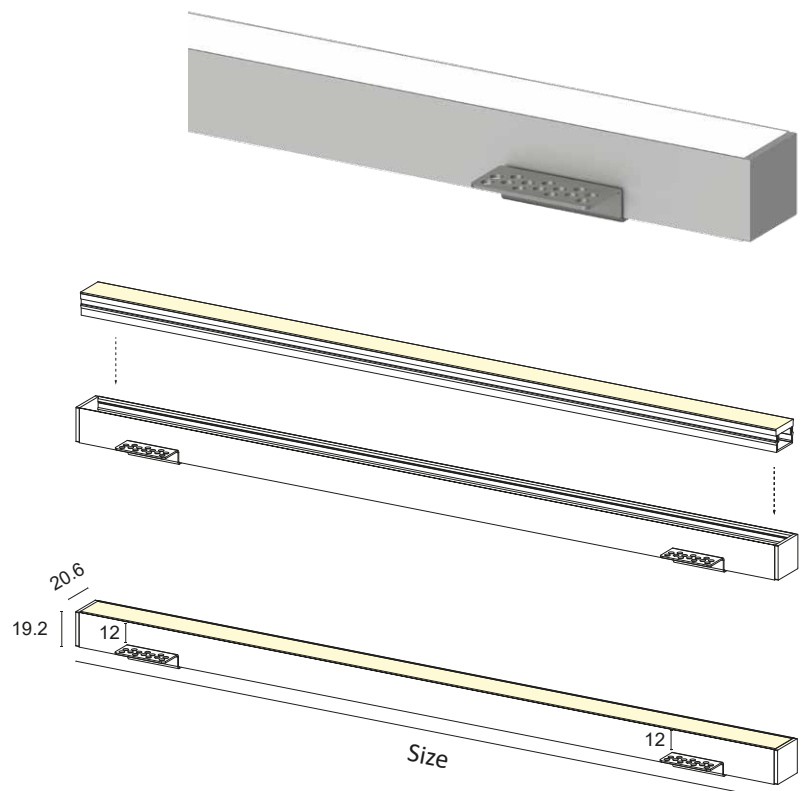
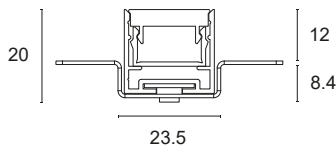



BASIC CODES

**Y3.**

FINISHES

- 1** White
  - 2** Matt black
  - 7** Brushed aluminium
- \*Other finishes on request.

SIDE SUPPORTS

- 1** White
- 2** Matt black
- 7** Brushed aluminium

SIZE

- D** 600mm
- E** 700mm
- F** 800mm
- G** 900mm
- H** 1000mm
- I** 1200mm
- J** 1300mm
- K** 1400mm
- L** 1500mm
- M** 1800mm
- N** 2000mm
- O** 2300mm
- P** 2500mm
- Q** 2800mm
- R** 3000mm

LED COLOUR

- BN** 4000K
  - BC** 3000K
  - CC** 2700K
- \*Strip also available coloured, Dynamic White, RGB and RGBW.

POWER

IP65	<b>D65</b>	10W/m	1400Lm/m	98LED/m	S2835	CRI>85	
IP54	<b>E54</b>	16.8W/m	2000Lm/m	140LED/m	S2835	CRI>85	
	<b>E</b>	16.8W/m	2000Lm/m	140LED/m	S2835	CRI>85	
	<b>E+</b>	16.8W/m	2000Lm/m	140LED/m	S2835	CRI>90	
	<b>F</b>	20.2W/m	2500Lm/m	168LED/m	S2835	CRI>85	
	<b>F+</b>	20.2W/m	2500Lm/m	168LED/m	S2835	CRI>90	

\*Energy class referring to light source

DIFFUSER

- S** BRUSHED

Code example:

YPSILON FLOOR LIGHT + White + Side supports white + 1000mm + 3000K + 20.2W/m CRI>85 + Brushed diffuser = Code: Y3.11HBCFS



## RGB SYSTEMS

SKY RGB	214
ALGOL RGB	215
HALLEY RGB	216
EOS RGB	217
BASIK 1 RGB	218
BASIK Q RGB	219
BIONIK 1 RGB	220
BIONIK Q RGB	221
FOUR HOLE RGB	222
FOUR HOLE Q RGB	223
DEHO 2 RGB	224
DEHO Q RGB	225
ACSO 1 RGB	226
VERTIGO RGB	227
DUVAR RGB	228

# SKY RGB

## L90.



Flush-fitted in polished aluminium for decoration and courtesy lighting. Suitable for creating an RGB 'starry sky' effect. Can be installed indoors and outdoors if partially protected, spring-mounted.

5mm high-brightness LED

Power: 0.3W

Power supply with 12Vdc constant voltage control unit, only with CNL/RGB box

Mandatory connection with CNL/RGB box, cable 150 cm

Compulsory accessories for connection page 247

Accessories for RGB management page 249



 **MADE IN ITALY**

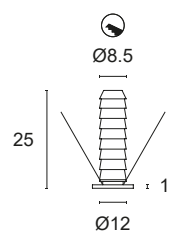

**BASIC CODES**

**L90.**

**FINISHES**

- 1 White
- 2 Matt black
- 6 Chrome

**LED COLOUR**

 **RGB**

**Code example:**

SKY RGB + Chrome + RGB = Code: L90.6RGB



# ALGOL RGB

## L80.



Flush-fitted in polished aluminium for decoration and courtesy lighting. Suitable for creating an RGB 'starry sky' effect. Can be installed indoors and outdoors if partially protected, spring-mounted.

5mm high-brightness LED

Power: 0.3W

Power supply with 12Vdc constant voltage control unit, only with CNL/RGB box

Mandatory connection with CNL/RGB box, cable 150 cm

Compulsory accessories for connection page 247

Accessories for RGB management page 249

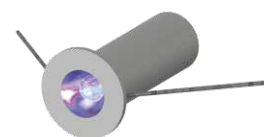

 **MADE IN ITALY**

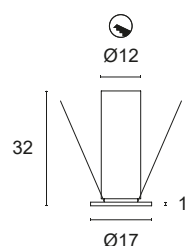
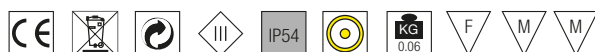

**BASIC CODES**

**L80.**

**FINISHES**

- 1 White
- 2 Matt black
- 6 Chrome

**LED COLOUR**

 **RGB**

**Code example:**

ALGOL RGB + Chrome + RGB = Code: L80.6RGB



# HALLEY RGB

## L31.



Flush-fitted in polished aluminium for accent, decoration and courtesy RGB lighting. Also indicated for 'starry sky'. Can be installed indoors and outdoors if partially protected, spring-mounted.

5mm high-brightness LED

Power: 0.3W

Power supply with 12Vdc constant voltage control unit, only with CNL/RGB box

Mandatory connection with CNL/RGB box, cable 150 cm

Compulsory accessories for connection page 247

Accessories for RGB management page 249

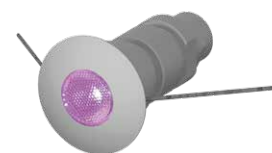

 **MADE IN ITALY**

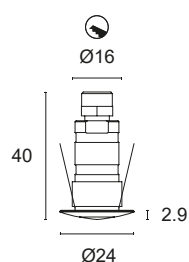

**BASIC CODES**

**L31.**

**FINISHES**

- 1 White
- 2 Matt black
- 6 Chrome
- 7 Brushed aluminium

**GLASS**

- T Transparent

**LED COLOUR**

 **RGB**

**Code example:**

HALLEY RGB + White + Clear Glass + RGB = Code: L31.1TRGB

# EOS RGB

L95.

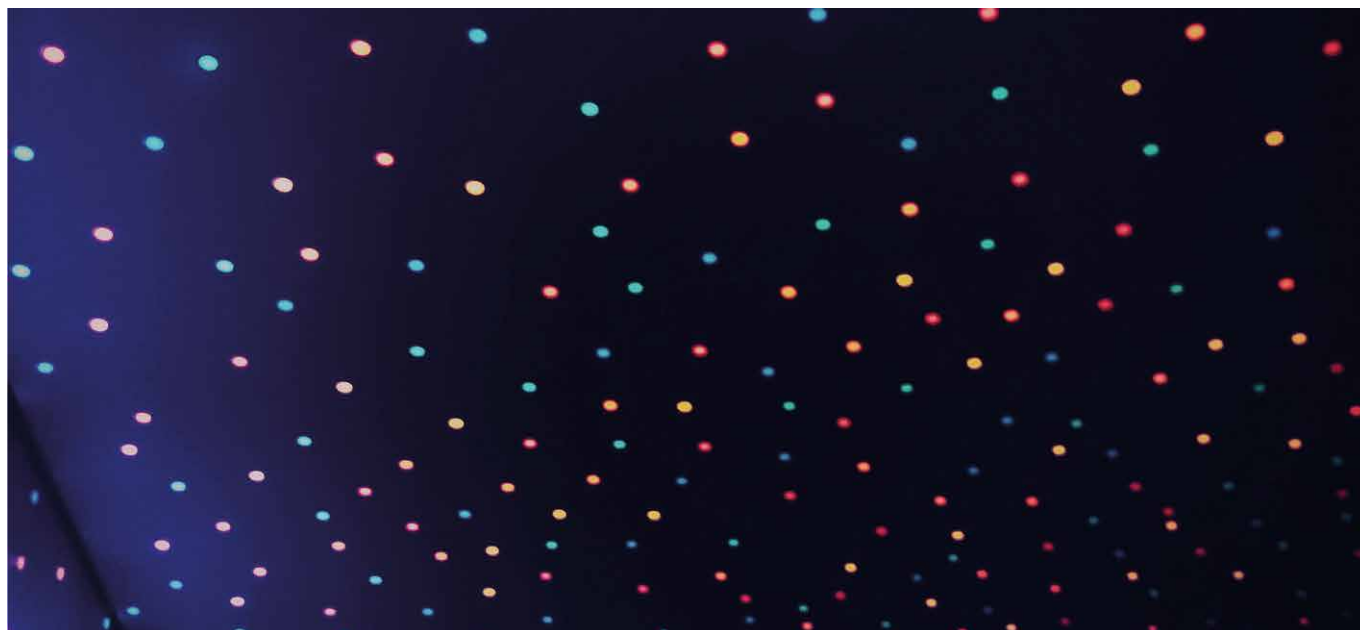

Flush-fitted in thermoplastic with power RGB for accent, decoration and courtesy lighting. Choice of secondary optics, can be installed indoors, press-fit.

Power LED CRI>80

Power: 3W@350mA

350mA constant current power supply

Series connection, with 70 + 70 cm cables

Accessories for RGB management page 249



 **MADE IN ITALY**

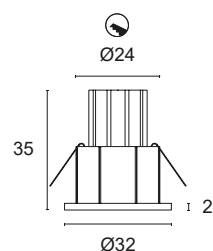

## BASIC CODES

**L95.**

## FINISHES

- 1 White
- 2 Matt black
- 3 Brushed gold
- 6 Chrome
- 7 Brushed aluminium
- 8 Transparent
- 9 Polished gold

## LIGHT BAND

- 15 15°
- 25 25°
- 40 40°
- 60 60°
- 80 80°

## LED COLOUR

 **RGB**

## Code example:

EOS RGB + Brushed Aluminium + 15° light beam + RGB = Code: L95.715RGB

# BASIK 1 RGB

L01.



Turned and decorated aluminium recessed light with powerful RGB LEDs suitable for decorative lighting of residential and retail environments. Choice of secondary optics, can be flush fitted indoors and outdoors if partially protected. Flush-mounted with springs.

Power LED CRI>80

Power: 3W@350mA

350mA constant current power supply

Series connection, with 70 + 70 cm cables

Accessories for RGB management page 249



 **MADE IN ITALY**

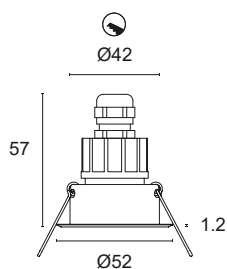

**BASIC CODES**

**L01.**

**FINISHES**

- 1 White
- 2 Matt black
- 5 Gloss aluminium
- 6 Chrome
- 7 Brushed aluminium

**LIGHT BAND**

- 15 15°
- 25 25°
- 40 40°
- 60 60°
- 80 80°

**LED COLOUR**

 **RGB**

**Code example:**

BASIK 1 RGB + Brushed Aluminium + 15° light beam + RGB = Code: L01.715RGB

# BASIK Q RGB

L02.



Turned and decorated aluminium recessed light with powerful RGB LEDs suitable for decorative lighting of residential and retail environments. Choice of secondary optics, can be flush fitted indoors and outdoors if partially protected. Flush-mounted with springs.

Power LED CRI>80

Power: 3W@350mA

350mA constant current power supply

Series connection, with 70 + 70 cm cables

Accessories for RGB management page 249



 **MADE IN ITALY**

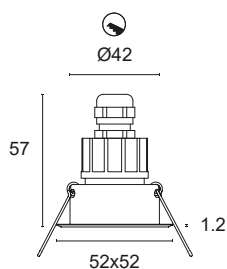

**BASIC CODES**

**L02.**

**FINISHES**

- 1 White
- 2 Matt black
- 5 Gloss aluminium
- 6 Chrome
- 7 Brushed aluminium

**LIGHT BAND**

- 15 15°
- 25 25°
- 40 40°
- 60 60°
- 80 80°

**LED COLOUR**

 **RGB**

**Code example:**

BASIK Q RGB + Brushed Aluminium + 15° light beam + RGB = Code: L02.715RGB

# BIONIK 1 RGB

L21.



Turned and decorated aluminium recessed light with powerful RGB LEDs suitable for decorative lighting of residential and retail environments. Choice of secondary optics, can be flush fitted indoors and outdoors if partially protected. Flush-mounted with springs.

Power LED CRI>80

Power: 3W@350mA

350mA constant current power supply

Series connection, with 70 + 70 cm cables

Accessories for RGB management page 249



 **MADE IN ITALY**

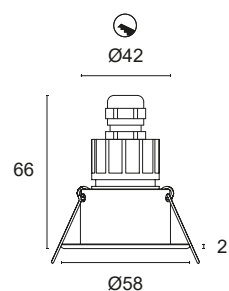

**BASIC CODES**

**L21.**

**FINISHES**

- 1 White
- 2 Matt black
- 5 Gloss aluminium
- 6 Chrome
- 7 Brushed aluminium

**LIGHT BAND**

- 15 15°
- 25 25°
- 40 40°
- 60 60°
- 80 80°

**LED COLOUR**

 **RGB**

**Code example:**

BIONIK 1 RGB + Brushed Aluminium + 15° light beam + RGB = Code: L21.715RGB



# BIONIK Q RGB

L22.



Turned and decorated aluminium recessed light with powerful RGB LEDs suitable for decorative lighting of residential and retail environments. Choice of secondary optics, can be flush fitted indoors and outdoors if partially protected. Flush-mounted with springs.

Power LED CRI>80

Power: 3W@350mA

350mA constant current power supply

Series connection, with 70 + 70 cm cables

Accessories for RGB management page 249



 **MADE IN ITALY**

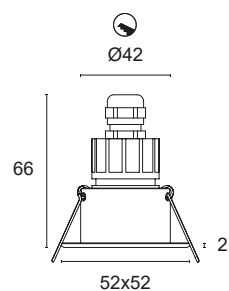
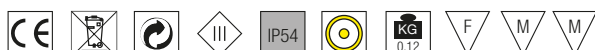

BASIC CODES

**L22.**

FINISHES

- 1 White
- 2 Matt black
- 5 Gloss aluminium
- 6 Chrome
- 7 Brushed aluminium

LIGHT BAND

- 15 15°
- 25 25°
- 40 40°
- 60 60°
- 80 80°

LED COLOUR

 **RGB**

Code example:

BIONIK Q RGB + Brushed Aluminium + 15° light beam + RGB = Code: L22.715RGB

# FOUR HOLE RGB

## L24.



Turned and decorated aluminium recessed light with powerful RGB LEDs suitable for decorative lighting of residential and retail environments. Choice of secondary optics, can be flush fitted indoors. Flush-mounted with springs.

Power LED CRI>80

Power: 3W@350mA

350mA constant current power supply

Series connection, with 70 + 70 cm cables

Accessories for RGB management page 249



 **MADE IN ITALY**

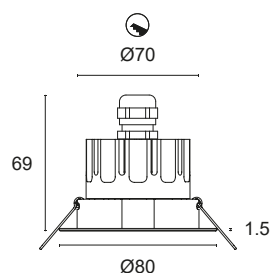

**BASIC CODES**

**L24.**

**FINISHES**

- 1 White
- 2 Matt black
- 5 Gloss aluminium
- 7 Brushed aluminium

**LIGHT BAND**

- 10 10°
- 35 35°
- 60 60°
- 80 80°

**LED COLOUR**

 **RGB**

**Code example:**

FOUR HOLE RGB + White + 80° light beam + RGB = Code: L24.180RGB

# FOUR HOLE Q RGB

L25.



Turned and decorated aluminium recessed light with powerful RGB LEDs suitable for decorative lighting of residential and retail environments. Choice of secondary optics, can be flush fitted indoors. Flush-mounted with springs.

Power LED CRI>80

Power: 3W@350mA

350mA constant current power supply

Series connection, with 70 + 70 cm cables

Accessories for RGB management page 249



 **MADE IN ITALY**

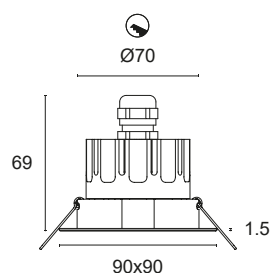

**BASIC CODES**

**L25.**

**FINISHES**

- 1 White
- 2 Matt black
- 5 Gloss aluminium
- 7 Brushed aluminium

**LIGHT BAND**

- 10 10°
- 35 35°
- 60 60°
- 80 80°

**LED COLOUR**

 **RGB**

**Code example:**

FOUR HOLE Q RGB + White + 80° light beam + RGB = Code: L25.180RGB

# DEHO 2 RGB

L402.



Polished 304 steel casing with powerful RGB LEDs suitable for decorative lighting and as step markers. Choice of secondary optics, can be fitted in the floor, wall or in plasterboard indoors and outdoors. Mounting with formwork or ring with springs.

Power LED CRI>80

Power: 3W@350mA

350mA constant current power supply

Series connection, with 70 + 70 cm cables

Installation accessories page 271

Accessories for RGB management page 249





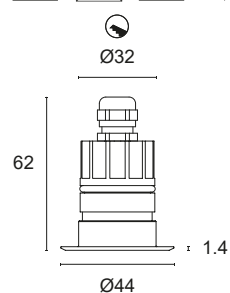

 **MADE IN ITALY**



**BASIC CODES**

**L402.**

**LIGHT BAND**

-  **15** 15°
-  **25** 25°
-  **40** 40°
-  **60** 60°
-  **80** 80°

**GLASS**

- T** Transparent

**LED COLOUR**

 **RGB**

**Code example:**

DEHO 2 RGB + Light Beam 25° + Clear Glass + RGB = Code: L402.25TRGB

# DEHO Q RGB

## L405.



Polished 304 steel casing with powerful RGB LEDs suitable for decorative lighting and as step markers. Choice of secondary optics, can be fitted in the floor, wall or in plasterboard indoors and outdoors. Mounting with formwork or ring with springs.

Power LED CRI>80

Power: 3W@350mA

350mA constant current power supply

Series connection, with 70 + 70 cm cables

Installation accessories page 271

Accessories for RGB management page 249





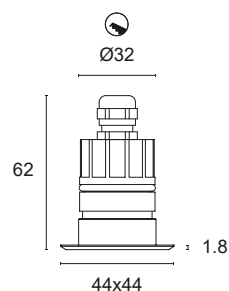

 **MADE IN ITALY**



BASIC CODES

**L405.**

LIGHT BAND

-  **15** 15°
-  **25** 25°
-  **40** 40°
-  **60** 60°
-  **80** 80°

GLASS

- T** Transparent

LED COLOUR

 **RGB**

Code example:

DEHO Q RGB + Light Beam 25° + Clear Glass + RGB = Code: L405.25TRGB



# ACSO 1 RGB

L601.



Polished 304 steel casing with powerful RGB LEDs suitable for decorative lighting and as step markers. Choice of secondary optics, can be fitted in the floor, wall or in plasterboard indoors and outdoors. Mounting with formwork or ring with springs.

Power LED CRI>80

Power: 3W@350mA

350mA constant current power supply

Series connection, with 70 + 70 cm cables

Installation accessories page 270

Accessories for RGB management page 249





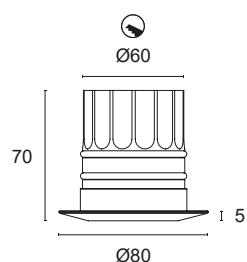

 **MADE IN ITALY**



BASIC CODES

**L601.**

LIGHT BAND

-  **15** 15°
-  **25** 25°
-  **40** 40°
-  **60** 60°
-  **80** 80°

GLASS

- T** Transparent

LED COLOUR

 **RGB**

Code example:

ACSO 1 RGB + Light Beam 25° + Clear Glass + RGB = Code: L601.25TRGB

# VERTIGO RGB

## L14.

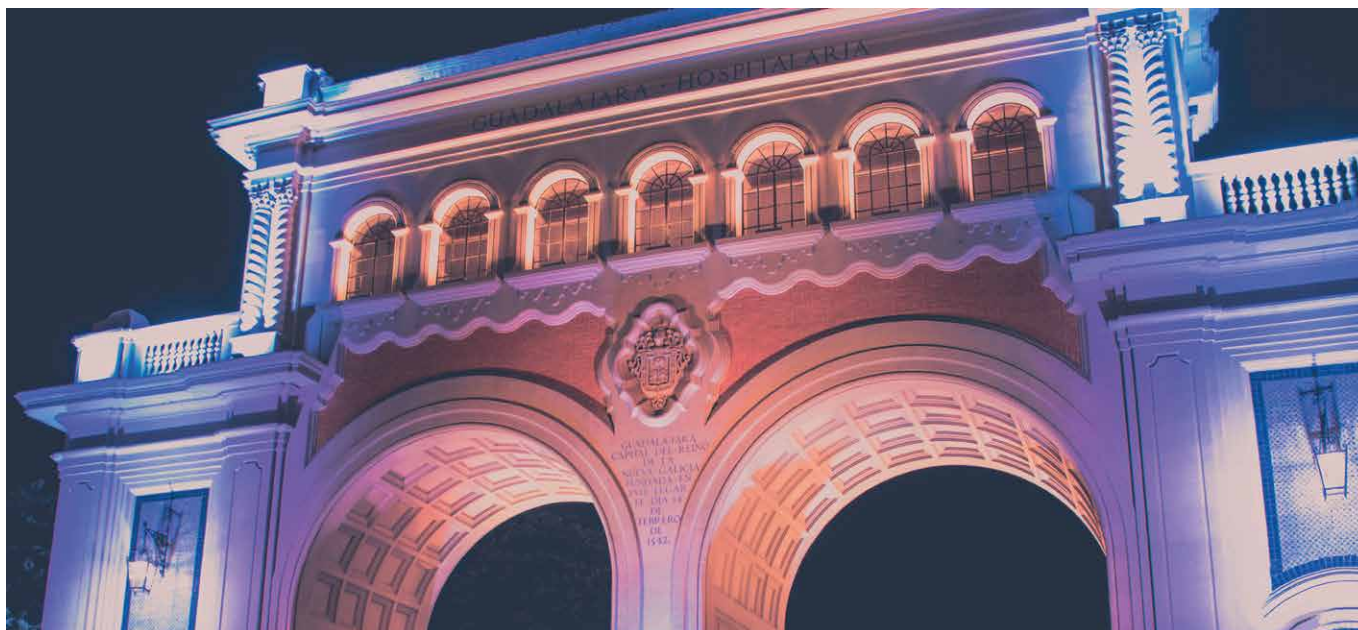

Directional projector made of polished aluminium with powerful RGB LEDs suitable for illuminating architectural facades, shop windows or gardens. Choice of secondary optics, can be fitted in the floor, wall or in plasterboard indoors and outdoors, with screw brackets.

Power LED CRI>80

Power: 3W@350mA

350mA constant current power supply

Series connection, with 70 + 70 cm cables

Installation accessories page 272

Accessories for RGB management page 249



 **MADE IN ITALY**

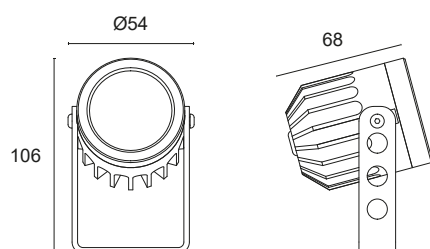





BASIC CODES

**L14.**

FINISHES

-  **2** Matt black
-  **7** Brushed aluminium

LIGHT BAND

-  **10** 10°
-  **35** 35°
-  **60** 60°
-  **80** 80°

LED COLOUR

 **RGB**

Code example:

VERTIGO RGB + Brushed Aluminium + 10° light beam + RGB = Code: L14.710RGB

# DUVAR RGB

## L23.

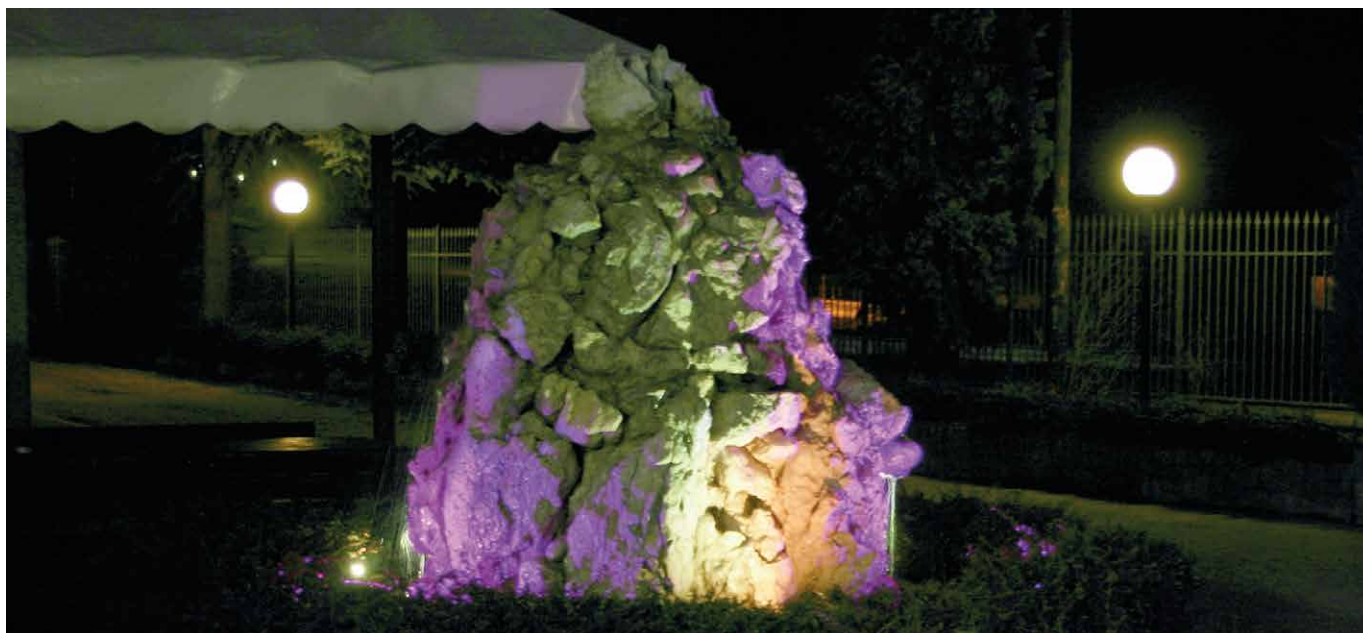

Directional projector made of polished aluminium with powerful RGB LEDs suitable for decorative lighting of architectural facades, shop windows or gardens. Choice of secondary optics, can be fitted in the floor, wall or in plasterboard indoors and outdoors, with screw brackets, base or spike.

Power LED CRI>80

Power: 3W@350mA

350mA constant current power supply

Series connection, with 70 + 70 cm cables

Installation accessories page 272

Accessories for RGB management page 249



 **MADE IN ITALY**

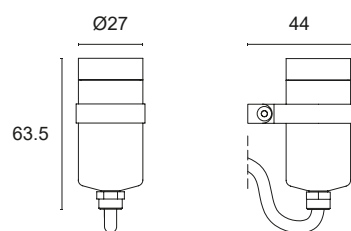



**BASIC CODES**

**L23.**

**FINISHES**

-  **2** Matt black
-  **7** Brushed aluminium

**LIGHT BAND**

-  **15** 15°
-  **25** 25°
-  **35** 35°

**LED COLOUR**

 **RGB**

Code example:

DUVAR RGB + Brushed Aluminium + 15° light beam + RGB = Code: L23.715RGB









## POWER SUPPLIES

350mA CONSTANT CURRENT .....	232
500mA CONSTANT CURRENT .....	233
CONSTANT CURRENT FOR COB .....	234
MULTICURRENT .....	235
CONSTANT VOLTAGE 12Vdc .....	236
CONSTANT VOLTAGE 24Vdc .....	237
CONSTANT VOLTAGE 24Vdc DALI2 AND PUSH .....	239
EMERGENCY DEVICE .....	241

# 350mA CONSTANT CURRENT

CODE	DESCRIPTION
<b>AL35004IP</b>	Power supply ON/OFF constant current 350mA 4W IN/OUT cables, IP65 Vin 220-240Vac 1 to 3 LEDs Dimensions mm 38x28x22H

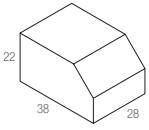

CODE	DESCRIPTION
<b>AL1435IP</b>	Power supply ON/OFF constant current 350mA 14W IN/OUT cables, IP67 Vin 220-240Vac 1 to 12 LEDs Sizes mm 70x38x25H

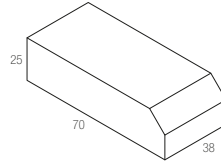

CODE	DESCRIPTION
<b>AL141132</b>	Power supply ON/OFF constant current 350mA 8W Protected screw terminals, IP20 Vin 110-240Vac 1 to 7 LEDs Sizes mm 59x42x22H

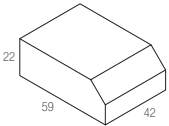

CODE	DESCRIPTION
<b>AL127713</b>	Power supply ON/OFF constant current 350mA 14.5W Protected screw terminals, IP20 Vin 110-240Vac 1 to 12 LEDs Sizes mm 115x34x20H

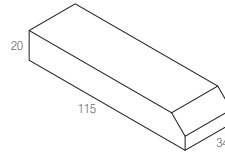

CODE	DESCRIPTION
<b>AL127303</b>	Power supply ON/OFF constant current 350mA 10W Protected screw terminals, IP20 Vin 110-240Vac 1 to 9 LEDs Sizes mm 112x38x22H

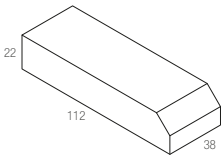

# 500mA CONSTANT CURRENT

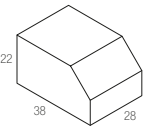
CODE	DESCRIPTION
<b>AL50004IP</b>	Power supply ON/OFF constant current 500mA 4W IN/OUT cables, IP65 Vin 220-240Vac 1 to 2 LEDs Dimensions mm 38x28x22H
	

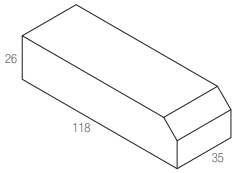
CODE	DESCRIPTION
<b>AL50020IP</b>	Power supply ON/OFF constant current 500mA 17.5W IN/OUT cables, IP67 Vin 110-240Vac 2 to 10 LEDs Sizes mm 118x35x26H
	

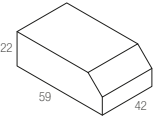
CODE	DESCRIPTION
<b>AL141131</b>	Power supply ON/OFF constant current 500mA 6W Protected screw terminals, IP20 Vin 110-240Vac 1 to 3 LEDs Sizes mm 59x42x22H
	

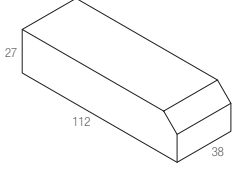
CODE	DESCRIPTION
<b>AL122248</b>	Power supply ON/OFF constant current 500mA 20W Protected screw terminals, IP20 Vin 110-240Vac 1 to 12 LEDs Sizes mm 112x38x27H
	

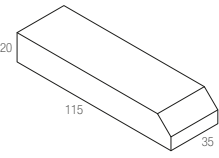
CODE	DESCRIPTION
<b>AL127711</b>	Power supply ON/OFF constant current 500mA 12W Protected screw terminals, IP20 Vin 110-240Vac 1 to 7 LEDs Sizes mm 115x35x20H
	

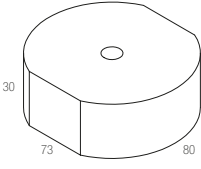
CODE	DESCRIPTION
<b>AL50022IP</b>	Power supply ON/OFF constant current 500mA 22W IN/OUT cables, IP65 Vin 110-240Vac 3 to 10 LEDs Sizes mm 80x73x30H
	

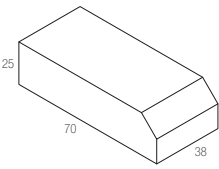
CODE	DESCRIPTION
<b>AL1450IP</b>	Power supply ON/OFF constant current 500mA 14W IN/OUT cables, IP67 Vin 220-240Vac 1 to 7 LEDs Sizes mm 70x38x25H
	

# CONSTANT CURRENT FOR COB

CODE	DESCRIPTION
<b>AL20009</b>	Power supply ON/OFF constant current 200mA 9W IN/OUT cables, IP20 Vin 220-240Vac Sizes mm 48x34x24H

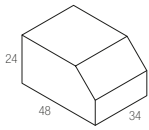

CODE	DESCRIPTION
<b>AL1020IP</b>	Power supply ON/OFF constant current 200mA 8W IN/OUT cables, IP67 Vin 220-240Vac Sizes mm 70x38x25H

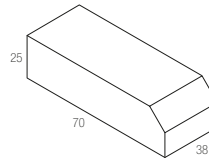

CODE	DESCRIPTION
<b>AL25012</b>	Power supply ON/OFF constant current 250mA 10W Protected pressure terminals, IP20 Vin 220-240Vac Sizes mm 100x38x25H

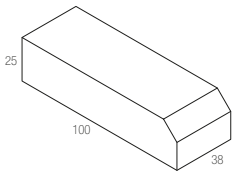

CODE	DESCRIPTION	CONSTANT CURRENT	CONSTANT VOLTAGE
<b>AL45018.MULTI</b>	Multicurrent ON/OFF power supply 200-450mA 18.9W Protected pressure terminals, IP20 Vin 220-240Vac Sizes mm 98x44x30H	200mA 8.4W 240mA - 10.1W 300mA - 12.6W 350mA 14.7W 400mA - 16.8W 450mA 18.9W	24-42Vdc - 18.9W

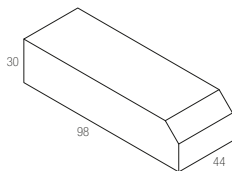

CODE	DESCRIPTION	CONSTANT CURRENT
<b>AL105042.D2</b>	Multicurrent Power Supply DIMMABLE DALI2 and PUSH 150-1050mA 42W Protected pressure terminals, IP20 Vin 220-240Vac Sizes mm 131x43x30H	150mA - 7.8W 200mA - 10.4W 250mA - 13W 300mA - 15.6W 350mA - 18.2W 400mA - 20.8W 500mA - 26W 600mA - 31.2W 700mA - 36.4W 750mA - 39W 800mA - 41.6W 850mA - 41.65W 900mA - 41.4W 950mA - 41.8W 1000mA - 42W

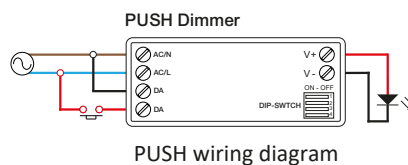
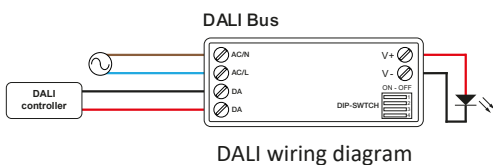
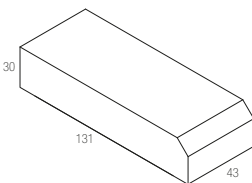

CODE	DESCRIPTION	CONSTANT CURRENT	CONSTANT VOLTAGE
<b>AL122201</b>	Multicurrent ON/OFF power supply 250-700mA 20W Protected pressure terminals, IP20 Vin 220-240Vac Sizes mm 112x52x22H	250mA - 13W min 3 - max 16 LEDs 350mA - 19W min 1 - max 16 LEDs 400mA - 20W min 1 - max 15 LEDs 450mA - 20W min 1 - max 13 LEDs 500mA - 20W min 1 - max 12 LEDs 550mA - 20W min 1 - max 11 LEDs 600mA - 20W min 1 - max 10 LEDs 700mA - 20W min 1 - max 9 LEDs	24Vdc - 16W

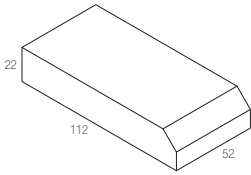

CODE	DESCRIPTION	CONSTANT CURRENT	CONSTANT VOLTAGE
<b>AL125400</b>	Multicurrent Power Supply PUSH DIMMABLE 250-900mA 20W Protected pressure terminals, IP20 Vin 110-240Vac Sizes mm 112x52x22H	250mA - 13W min 6 - max 16 LEDs 300mA - 15W min 6 - max 16 LEDs 350mA - 18W min 4 - max 15 LEDs 400mA - 20W min 4 - max 15 LEDs 450mA - 20W min 1 - max 14 LEDs 500mA - 20W min 1 - max 12 LEDs 550mA - 20W min 1 - max 11 LEDs 600mA - 20W min 1 - max 10 LEDs 650mA - 20W min 1 - max 9 LEDs 700mA - 20W min 1 - max 9 LEDs 750mA - 20W min 1 - max 8 LEDs 800mA - 20W min 1 - max 7 LEDs 850mA - 20W min 1 - max 7 LEDs 900mA - 20W min 1 - max 7 LEDs	12Vdc - 11W 24Vdc - 20W

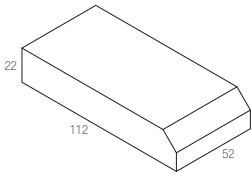

PUSH Dimmer

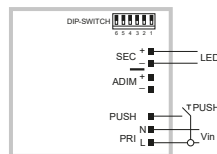

PUSH wiring diagram

CODE	DESCRIPTION	CONSTANT CURRENT
<b>AL70012.D2</b>	Multicurrent Power Supply DIMMABLE DALI2 and PUSH 150-700mA 12W Protected screw terminals, IP20 Vin 220-240Vac Sizes mm 120x30x20H	150mA - 6.3W min 1 - max 13 LEDs 200mA - 8.4W min 1 - max 13 LEDs 250mA - 10.5W min 1 - max 13 LEDs 300mA - 12W min 1 - max 12 LEDs 350mA - 12W min 1 - max 10 LEDs 500mA - 12W min 1 - max 7 LEDs 600mA - 12W min 1 - max 6 LEDs 700mA - 12W min 1 - max 5 LEDs

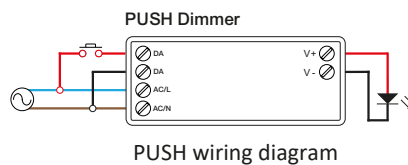
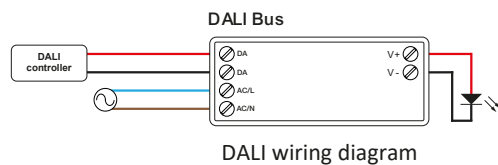
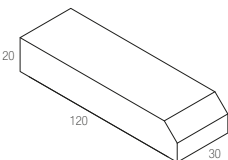



# CONSTANT VOLTAGE 12Vdc

CODE	DESCRIPTION
<b>AL12004</b>	Constant voltage power supply ON/OFF 12Vdc 4W IN/OUT cables, IP65 Vin 220-240Vac Dimensions mm 38x28x21H

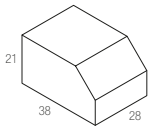

CODE	DESCRIPTION
<b>AL12075</b>	Constant voltage power supply ON/OFF 12Vdc 75W Protected screw terminals, IP20 Vin 220-240Vac Sizes mm 184x61x32H

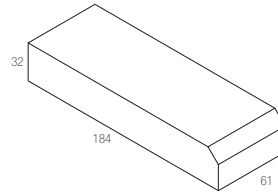

CODE	DESCRIPTION
<b>AL12015</b>	Constant voltage power supply ON/OFF 12Vdc 15W Protected screw terminals, IP20 Vin 220-240Vac Sizes mm 103x36x16H

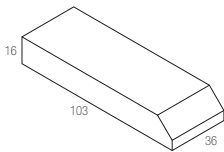

CODE	DESCRIPTION
<b>AL12100</b>	Constant voltage power supply ON/OFF 12Vdc 100W Protected screw terminals, IP20 Vin 110-240Vac Sizes mm 184x61x32H

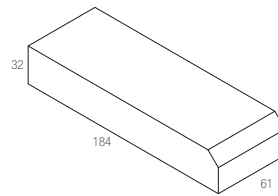

CODE	DESCRIPTION
<b>AL12020</b>	Constant voltage power supply ON/OFF 12Vdc 20W Protected pressure terminals, IP20 Vin 220-240Vac Sizes mm 103x36x16H

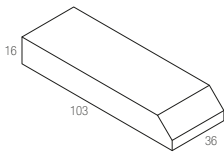

CODE	DESCRIPTION
<b>AL12100IP</b>	Constant voltage power supply ON/OFF 12Vdc 100W IN/OUT cables, IP67 Vin 110-240Vac Sizes mm 190x52x37H

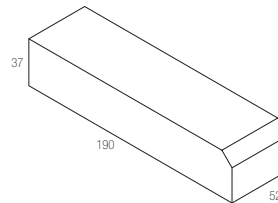

CODE	DESCRIPTION
<b>AL12030B</b>	Constant voltage power supply ON/OFF 12Vdc 30W Protected pressure terminals, IP20 Vin 220-240Vac Sizes mm 155x53x16H

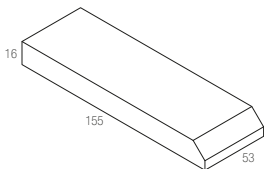

CODE	DESCRIPTION
<b>AL12150</b>	Constant voltage power supply ON/OFF 12Vdc 150W Protected screw terminals, IP20 Vin 220-240Vac Sizes mm 210x67x34H

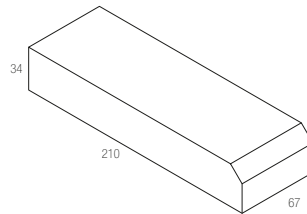

CODE	DESCRIPTION
<b>AL12035IP</b>	Constant voltage power supply ON/OFF 12Vdc 36W IN/OUT cables, IP67 Vin 110-240Vac Sizes mm 150x40x30H

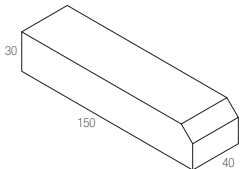

CODE	DESCRIPTION
<b>AL12050</b>	Constant voltage power supply ON/OFF 12Vdc 50W Protected screw terminals, IP20 Vin 110-240Vac Sizes mm 185x64x22H

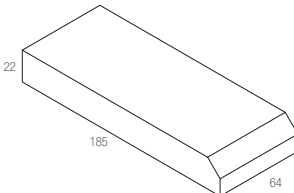

CODE	DESCRIPTION
<b>AL24015</b>	Constant voltage power supply ON/OFF 24Vdc 15W Protected pressure terminals, IP20 Vin 220-240Vac Sizes mm 103x36x16H

CODE	DESCRIPTION
<b>AL24060IP</b>	Constant voltage power supply ON/OFF 24Vdc 60W IN/OUT cables, IP67 Vin 110-240Vac Sizes mm 162x43x32H

CODE	DESCRIPTION
<b>AL24020</b>	Constant voltage power supply ON/OFF 24Vdc 20W Protected pressure terminals, IP20 Vin 220-240Vac Sizes mm 103x36x16H

CODE	DESCRIPTION
<b>AL24060S</b>	Constant voltage power supply ON/OFF 24Vdc 60W Protected screw terminals, IP20 Vin 220-240Vac Sizes mm 305x30x18H

CODE	DESCRIPTION
<b>AL24030B</b>	Constant voltage power supply ON/OFF 24Vdc 30W Protected screw terminals, IP20 Vin 220-240Vac Sizes mm 155x53x16H

CODE	DESCRIPTION
<b>AL24075</b>	Constant voltage power supply ON/OFF 24Vdc 75W Protected screw terminals, IP20 Vin 220-240Vac Sizes mm 184x61x32H

CODE	DESCRIPTION
<b>AL24035IP</b>	Constant voltage power supply ON/OFF 24Vdc 35W IN/OUT cables, IP67 Vin 110-240Vac Sizes mm 150x40x30H

CODE	DESCRIPTION
<b>AL24075S</b>	Constant voltage power supply ON/OFF 24Vdc 75W Protected screw terminals, IP20 Vin 220-240Vac Sizes mm 305x30x18H

CODE	DESCRIPTION
<b>AL24050B</b>	Constant voltage power supply ON/OFF 24Vdc 50W Protected screw terminals, IP20 Vin 110-240Vac Sizes mm 185x64x22H

CODE	DESCRIPTION
<b>AL24075X</b>	Constant voltage power supply ON/OFF 24Vdc 75W Protected pressure terminals, IP20 Vin 220-240Vac Sizes mm 168x38x30H

CODE	DESCRIPTION
<b>AL24060</b>	Constant voltage power supply ON/OFF 24Vdc 60W Protected screw terminals, IP20 Vin 220-240Vac Sizes mm 160x58x18H

CODE	DESCRIPTION
<b>AL24100</b>	Constant voltage power supply ON/OFF 24Vdc 100W Protected screw terminals, IP20 Vin 110-240Vac Sizes mm 184x61x32H

# CONSTANT VOLTAGE 24Vdc

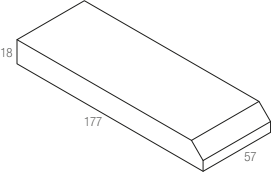
CODE	DESCRIPTION
<b>AL24100B</b>	Constant voltage power supply ON/OFF 24Vdc 100W Protected screw terminals, IP20 Vin 220-240Vac Sizes mm 177x57x18H
	

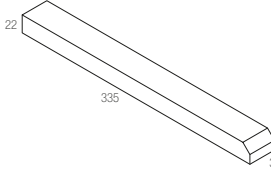
CODE	DESCRIPTION
<b>AL24150S</b>	Constant voltage power supply ON/OFF 24Vdc 150W Protected screw terminals, IP20 Vin 220-240Vac Sizes mm 335x30x22H
	

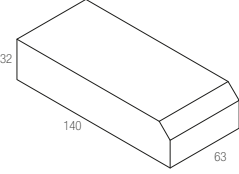
CODE	DESCRIPTION
<b>AL24100IP</b>	Constant voltage power supply ON/OFF 24Vdc 100W IN/OUT cables, IP67 Vin 110-240Vac Sizes mm 140x63x32H
	

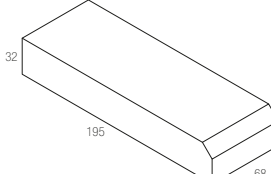
CODE	DESCRIPTION
<b>AL24200</b>	Constant voltage power supply ON/OFF 24Vdc 200W Protected screw terminals, IP20 Vin 220-240Vac Sizes mm 195x68x32H
	

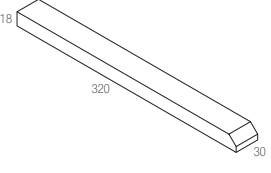
CODE	DESCRIPTION
<b>AL24100S</b>	Constant voltage power supply ON/OFF 24Vdc 100W Protected screw terminals, IP20 Vin 220-240Vac Sizes mm 320x30x18H
	

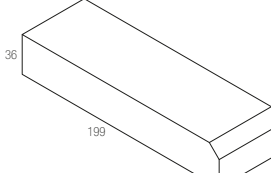
CODE	DESCRIPTION
<b>AL24200IP</b>	Constant voltage power supply ON/OFF 24Vdc 200W IN/OUT cables, IP67 Vin 110-240Vac Sizes mm 199x63x36H
	

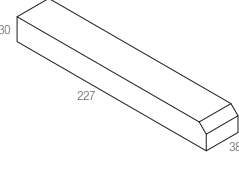
CODE	DESCRIPTION
<b>AL24120</b>	Constant voltage power supply ON/OFF 24Vdc 120W Protected pressure terminals, IP20 Vin 220-240Vac Sizes mm 227x38x30H
	

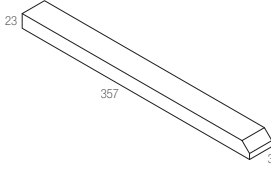
CODE	DESCRIPTION
<b>AL24240S</b>	Constant voltage power supply ON/OFF 24Vdc 240W Protected screw terminals, IP20 Vin 220-240Vac Sizes mm 357x32x23H
	

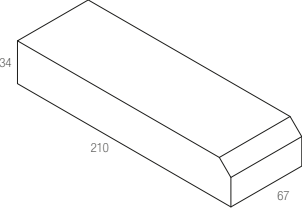
CODE	DESCRIPTION
<b>AL24150</b>	Constant voltage power supply ON/OFF 24Vdc 150W Protected screw terminals, IP20 Vin 220-240Vac Sizes mm 210x67x34H
	

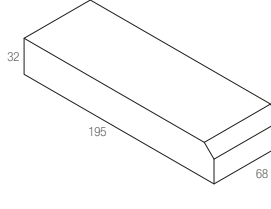
CODE	DESCRIPTION
<b>AL24250</b>	Constant voltage power supply ON/OFF 24Vdc 250W Protected screw terminals, IP20 Vin 220-240Vac Sizes mm 195x68x32H
	

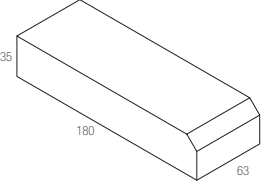
CODE	DESCRIPTION
<b>AL24150IP</b>	Constant voltage power supply ON/OFF 24Vdc 150W IN/OUT cables, IP67 Vin 110-240Vac Sizes mm 180x63x35H
	

# CONSTANT VOLTAGE 24Vdc DALI2 AND PUSH

CODE	DESCRIPTION	CONSTANT VOLTAGE
------	-------------	------------------

## AL24045.D2

DIMMABLE power supply  
DALI2 and PUSH  
Protected pressure terminals, IP20  
Vin 220-240Vac  
Sizes mm 187x45x31H

24Vdc - 45W

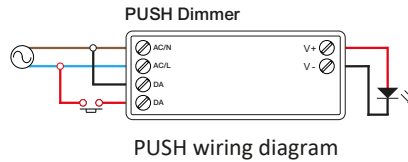
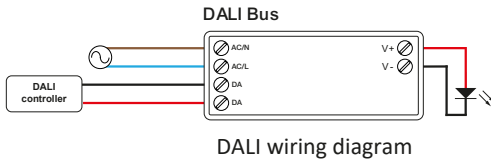
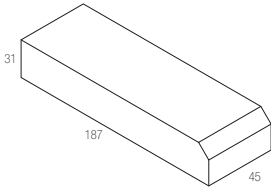

CODE	DESCRIPTION	CONSTANT VOLTAGE
------	-------------	------------------

## AL24060.SD2

DIMMABLE power supply  
DALI2 and PUSH  
Protected pressure terminals, IP20  
Vin 220-240Vac  
Sizes mm 362x30x21H

24Vdc - 60W

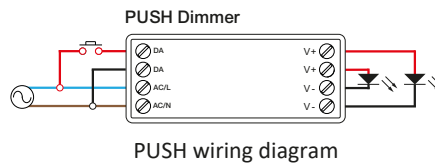
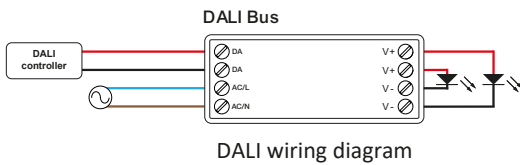
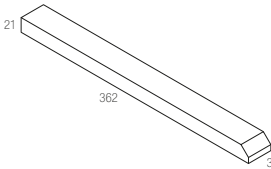

CODE	DESCRIPTION	CONSTANT VOLTAGE
------	-------------	------------------

## AL24080.D2

DIMMABLE power supply  
DALI2 and PUSH  
Protected pressure terminals, IP20  
Vin 220-240Vac  
Sizes mm 290x45x31H

24Vdc - 80W

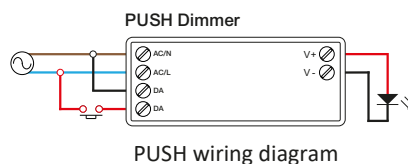
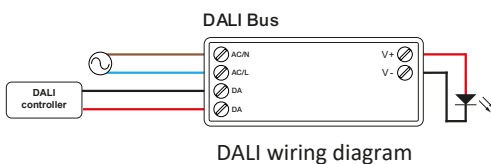
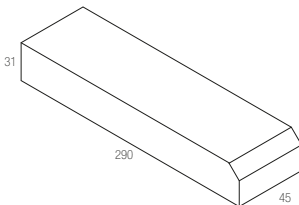

# CONSTANT VOLTAGE 24Vdc DALI2 AND PUSH

CODE	DESCRIPTION	CONSTANT VOLTAGE
------	-------------	------------------

**AL24150.D2**

DIMMABLE power supply  
DALI2 and PUSH  
Protected pressure terminals, IP20  
Vin 220-240Vac  
Sizes mm 290x45x31H

24Vdc - 150W

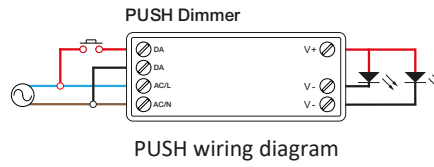
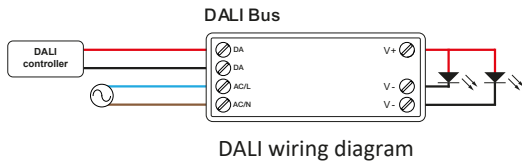
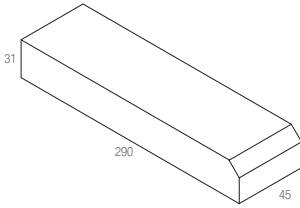

CODE	DESCRIPTION	CONSTANT VOLTAGE
------	-------------	------------------

**AL24150.SD2**

DIMMABLE power supply  
DALI2 and PUSH  
Protected pressure terminals, IP20  
Vin 220-240Vac  
Sizes mm 337x30x18H

24Vdc - 150W

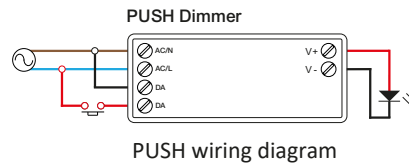
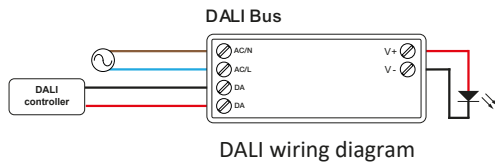
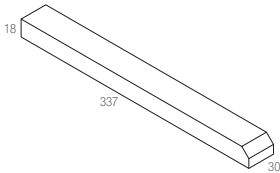

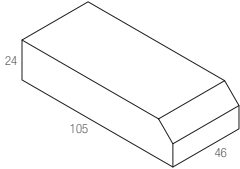
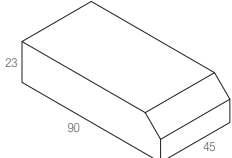

# EMERGENCY DEVICES

CODE	DESCRIPTION	CONSTANT CURRENT	CONSTANT VOLTAGE
<b>L1241</b>	Emergency lighting power supply with instant switch on if mains power fails. The device has combined operation for both continuous and emergency lighting. Suitable for power LEDs (max. 4W) or LED modules (12Vdc). Measurements of Power Supply mm 105x46x24H Measurements of Battery mm 90x45x23H	1W 350mA 4h autonomy 2W 350mA 3h autonomy 3W 350mA 2h autonomy	12Vdc - 3.6W 1h autonomy 12Vdc - 1.8W 2h autonomy 12Vdc - 1.2W 3h autonomy
Power supply			
Battery			

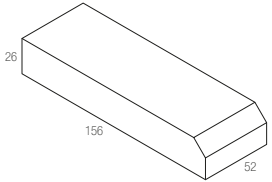
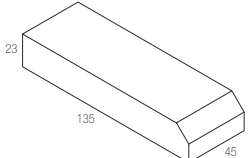
CODE	DESCRIPTION	DIP-SWITCH POSITION A	DIP-SWITCH POSITION B
<b>EL6171</b>	Emergency lighting only power supply with instant switch on if mains power fails. The device only operates continuously when combined with dimmable power controls. DIP-SWITCH adjustable version, for 350mA power LEDs or 12Vdc-24Vdc LED modules. Battery life 1h. Measurements of Power Supply mm 156x52x26H Measurements of Battery mm 135x45x23H	12Vdc - 24W 350mA	24Vdc - 48W 350mA
Power supply			
Battery			

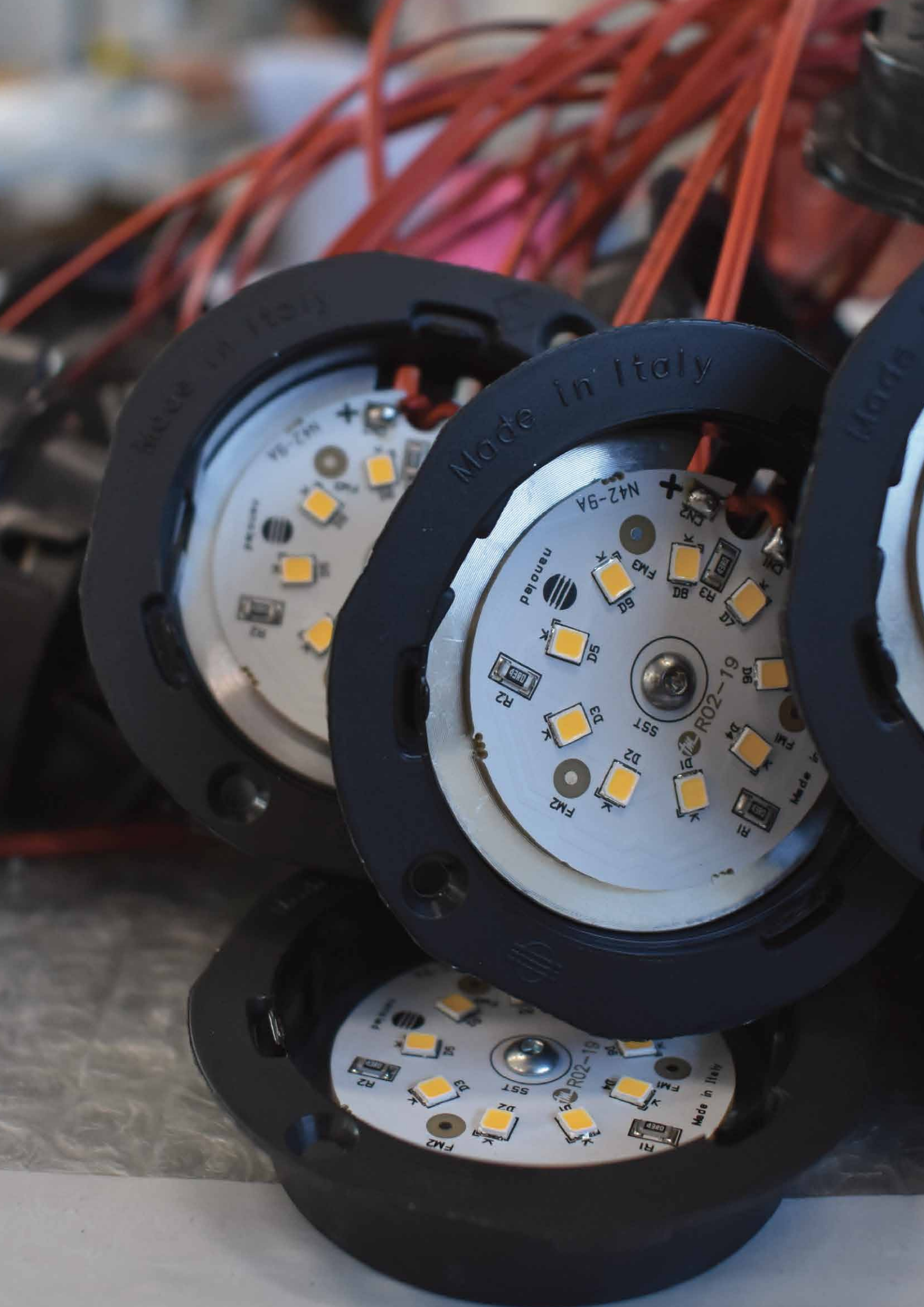

## CONNECTION SYSTEMS

SERIES CONNECTION .....	244
PARALLEL CONNECTION .....	245
SERIES-PARALLEL CONNECTION .....	246
RGB CONNECTION .....	247

# SERIES CONNECTION ACCESSORIES

SERIES connection boxes solely for power LEDs, suitable for easy installation and observing correct polarity. Available in three versions with three, four and six inputs. Boxes can also be connected to each other to expand the system. Indoor installation, connection cables 200mm, max. current 2.5A.

## CNL/03

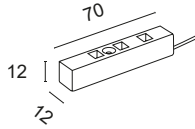

SERIES connection box solely for three-input power LEDs. If not all the Box inputs are used, a CLOSING BRIDGE must be used to close the circuit.

## CNL/03J

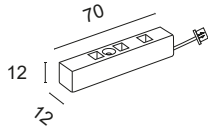

SERIES connection box solely for three-input power LEDs with connector on cable for connection to another box. If not all the Box inputs are used, a CLOSING BRIDGE must be used to close the circuit.

## CNL/04

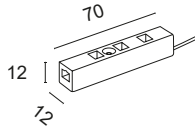

SERIES connection box solely for four-input power LEDs. If not all the Box inputs are used, a CLOSING BRIDGE must be used to close the circuit.

## CNL/04J

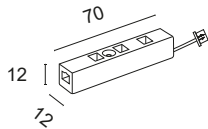

SERIES connection box solely for four-input power LEDs with connector on cable for connection to another box. If not all the Box inputs are used, a CLOSING BRIDGE must be used to close the circuit.

## CNL/06

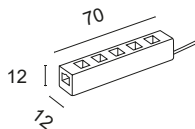

SERIES connection box solely for six-input power LEDs. If not all the Box inputs are used, a CLOSING BRIDGE must be used to close the circuit.

## CNL/06J

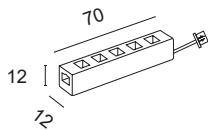

SERIES connection box solely for six-input power LEDs with connector on cable for connection to another box. If not all the Box inputs are used, a CLOSING BRIDGE must be used to close the circuit.

## P300



A closing bridge must be used if not all the Box inputs are used by the LEDs.

### EXAMPLE OF USE WITH SINGLE BOX

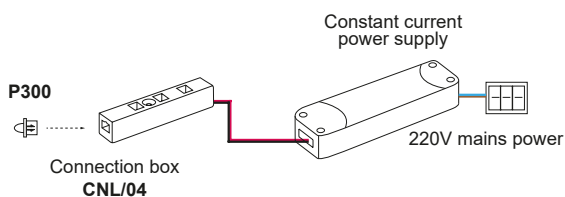

#### P300

A closing bridge must be used if not all the Box inputs are used by the LEDs.

### EXAMPLE OF USE WITH MULTIPLE BOXES

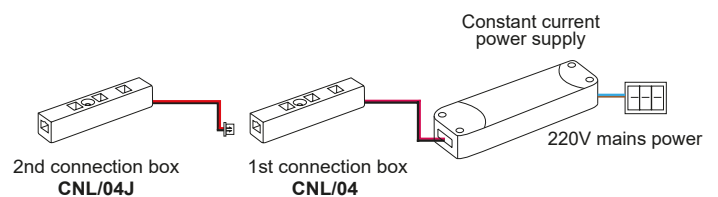

#### N.B.:

Boxes can also be connected to each other to expand the system. When connecting the boxes to each other, it should be noted that one input of the first box will be occupied by the connector of the second box.

#### EXAMPLE

Using a CNL/04 as the first box and a CNL/04J as the second box will not result in a total of eight inputs, but seven.

# PARALLEL CONNECTION ACCESSORIES

PARALLEL connection box solely for ALGOL model Microspots or large sections of monochrome LED strips. The box makes installation easier while observing the correct polarity. Available in a six-input version. Several boxes can be connected to the same power supply to expand the system. Indoor installation, connection cables 200mm, max. current 2.5A.

## CNP

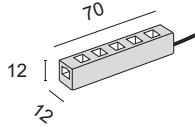

PARALLEL connection box solely for ALGOL model Microspots or large sections of monochrome LED strips. The circuit CLOSING BRIDGE is not necessary.

### EXAMPLE OF USE WITH SINGLE BOX

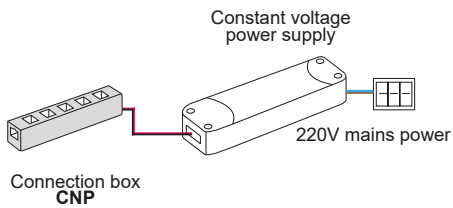

### EXAMPLE OF USE WITH MULTIPLE BOXES

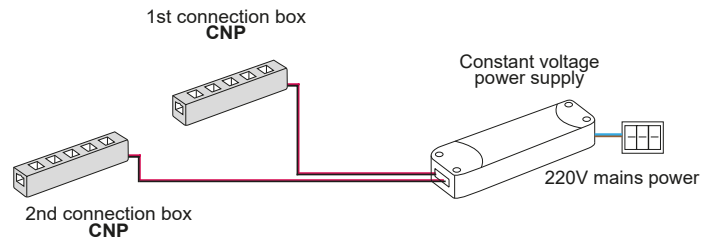



# SERIES-PARALLEL CONNECTION ACCESSORIES

SERIES-PARALLEL connection box solely for Microspot models DUST and SKY. The boxes must be used when installing and operating spotlights. Available in a six-input version. A multiplier box can be used to expand the system. Indoor installation, connection cables 200mm, max. current 2.5A.

## CNTG

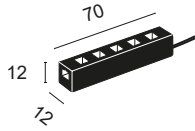

Box required for SERIES-PARALLEL connection of DUST and SKY microspots. Only three or six Microspots can be connected to the box.

## CNTG/J

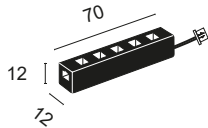

Box required for SERIES-PARALLEL connection of DUST and SKY microspots. Only three or six Microspots can be connected to the box. The box is equipped with a multiplier connector.

## CNTG/M

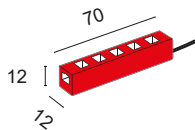

Multiplier box for system expansion with Microspot DUST and SKY. Up to six CNTG/J boxes can be connected to the box.

### EXAMPLE OF USE WITH SINGLE BOX

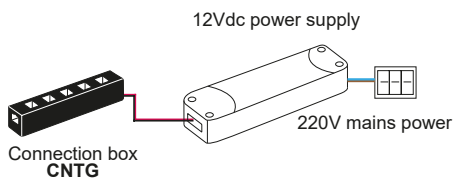

### EXAMPLE OF USE WITH MULTIPLE BOXES

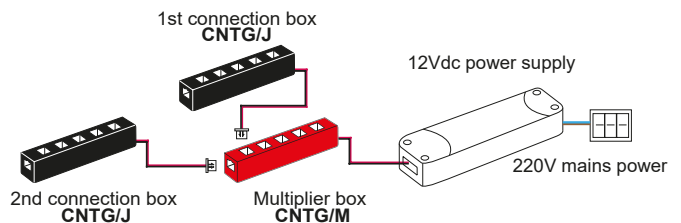

## CNTG/18

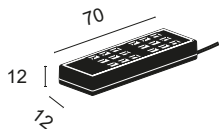

Box required for SERIES-PARALLEL connection of DUST and SKY microspots. Only three or multiples of three Microspots can be connected to the box.

## CNTG/18J

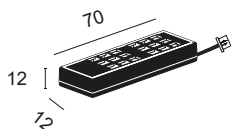

Box required for SERIES-PARALLEL connection of DUST and SKY microspots. Only three or multiples of three Microspots can be connected to the box. The box is equipped with a multiplier connector.

## CNTG/M

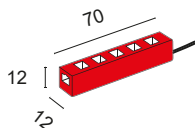

Multiplier box for system expansion with Microspot DUST and SKY. Up to six CNTG/18J boxes can be connected to the box.

### EXAMPLE OF USE WITH SINGLE BOX

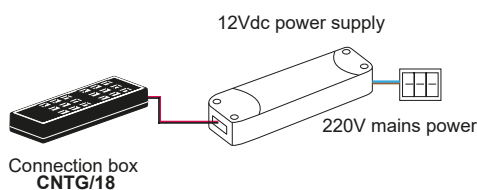

### EXAMPLE OF USE WITH MULTIPLE BOXES

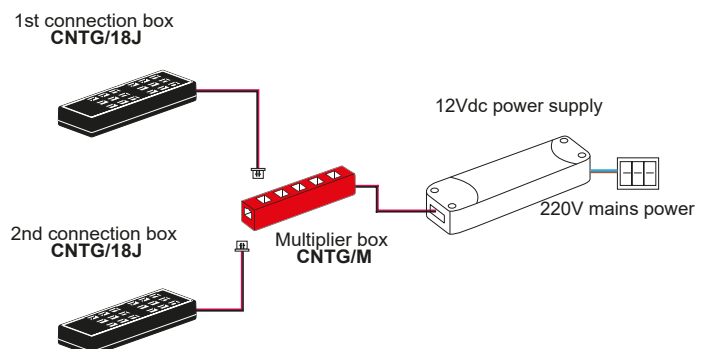

# SERIES CONNECTION RGB

Connection box solely for Microspot models SKY RGB, ALGOL RGB and HALLEY RGB. The boxes must be used when installing and operating spotlights. Available in a six-input version. A multiplier box can be used to expand the system. Indoor installation, connection cables 200mm, max. current 2.5A.

## CNL/RGB

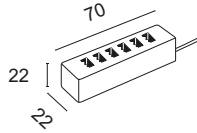

Mandatory box for connection of the Microspots SKY RGB, ALGOL RGB and HALLEY RGB. One to six microspots can be connected to the same box.

## CNL/RGBJ

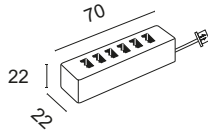

Mandatory box for connection of the Microspots SKY RGB, ALGOL RGB and HALLEY RGB. One to six microspots can be connected to the same box. The box is equipped with a multiplier connector.

## CNL/RGBM

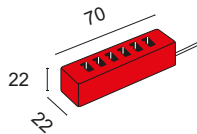

Multiplier box to be used for system expansion with Microspot DUST and SKY. Up to six CNL/RGBJ boxes can be connected to this box.

### EXAMPLE OF USE WITH SINGLE BOX

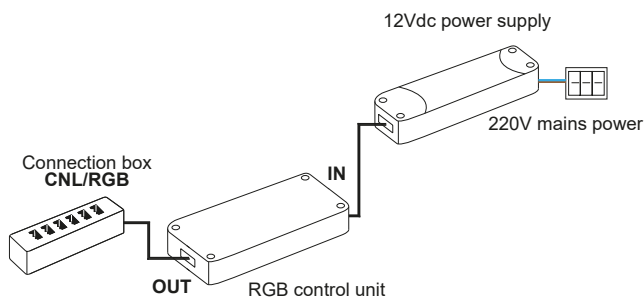

### EXAMPLE OF USE WITH MULTIPLE BOXES

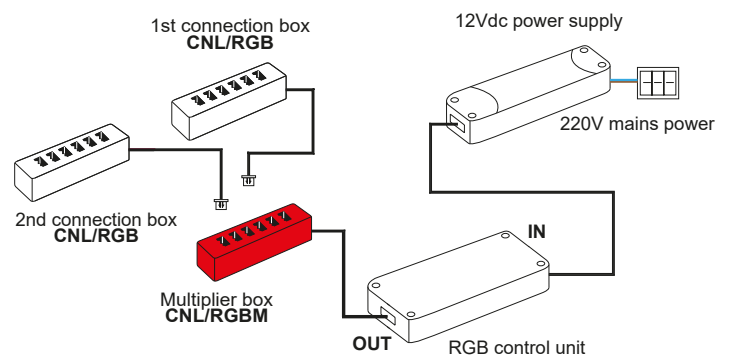



## CONTROL SYSTEMS

SK-V1 CONTROL UNIT.....	250
RF.001 CONTROL UNIT.....	251
SR-1029 CONTROL UNIT.....	252
RFL20K CONTROL UNIT.....	253
SR-1029W CONTROL UNIT.....	254
1009FA3 CONTROL UNIT.....	255
DLM1224-1CV CONTROL UNIT.....	256
MINI-1CV CONTROL UNIT.....	257
MINI-1CV-DALI CONTROL UNIT.....	258
MINI-1CV-CASAMBI CONTROL UNIT.....	259
LINE-5CV CONTROL UNIT.....	260
DLX1224-4CV-DALI CONTROL UNIT.....	261
LINE 5CV-CASAMBI CONTROL UNIT.....	262
DLC1248-1CC350 CONTROL UNIT.....	263
DLC1248-1CC500 CONTROL UNIT.....	263
DLX1224-4CC350 CONTROL UNIT.....	264
DLX1224-4CC500 CONTROL UNIT.....	264
VOLUMETRIC SENSOR.....	265
INFRARED SENSOR.....	265
TOUCH SENSOR.....	265
TOUCH MINI SENSOR.....	266
TOUCH DIMMER SENSOR.....	266
MINI MOTION DETECTOR SENSOR.....	267
TOUCH SENSOR SWITCH SENSOR.....	267
IR SENSOR SWITCH SENSOR.....	267

# SK-V1 control unit

Professional multifunctional control unit with PUSH or radio remote control for monochrome strips. Active memory function. A remote control or button can be combined with several control units to expand the system

Power supply voltage:  $V_{in} = V_{out} - 5 \dots 36Vdc$

Output current: 1x8A - 5...36Vdc

Power rating: 40W@5Vdc - 96W@12Vdc - 192W@24Vdc - 288W@36Vdc

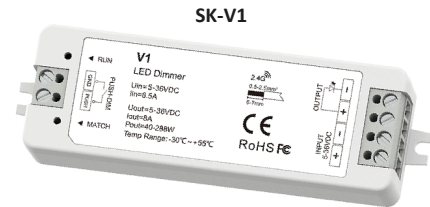
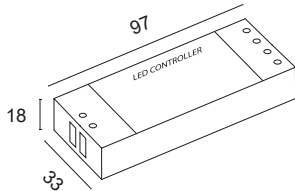

## SK-R11

### Radio remote control for monochrome LEDs

Radio remote control with magnetic or screw base for switching on, adjusting and switching off.



## SK-R1-1W

### Radio remote control for dynamic white LED

Round white Touch radio remote control with magnetic base or screw base for switching on, adjusting and switching off.



## EXAMPLE OF MONOCHROME LED STRIP CONTROL WITH A CONTROL UNIT

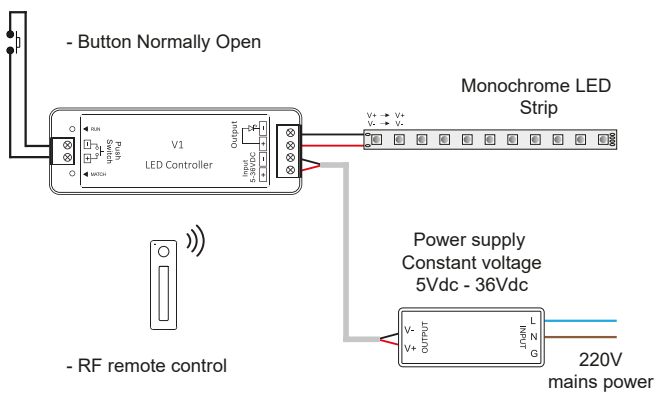

## EXAMPLE OF MONOCHROME LED STRIP CONTROL WITH TWO CONTROL UNITS

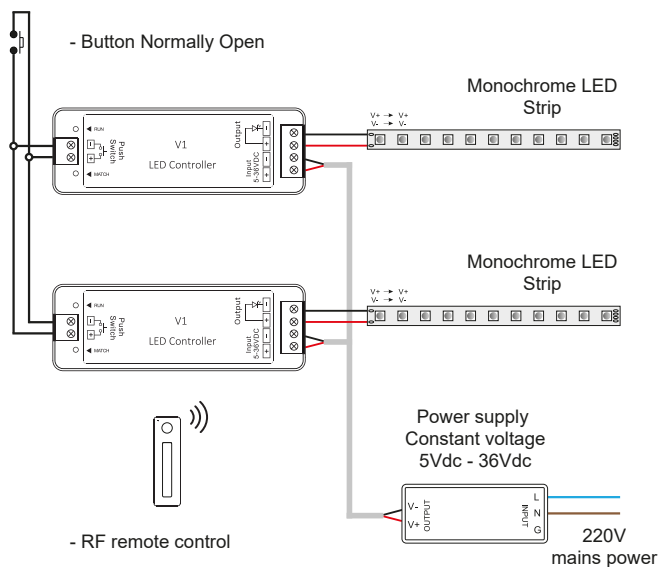



# RF.001 control unit

One-channel control unit for 12Vdc or 24Vdc constant voltage control of monochrome LED strips, radio remote control included. On/off, dimmer and active memory function. Possibility of expanding the system with up to nine RF.AMF amplifiers. Installation in unshielded indoor locations.

Power supply voltage:  $V_{in} = V_{out} - 12/24Vdc$

Output current: 8A - 12/24Vdc

Power rating: 96W@12Vdc - 192W@24Vdc

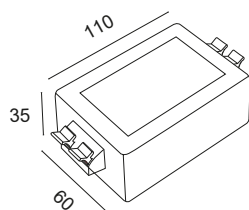

## EXAMPLE OF MONOCHROME LED STRIP CONTROL

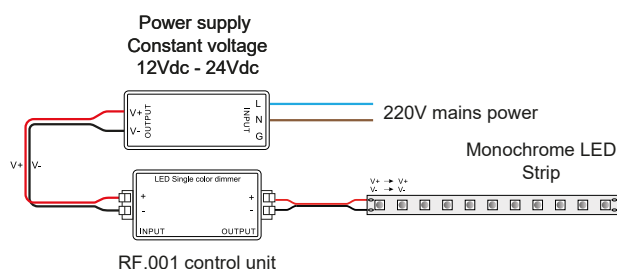

## EXAMPLE OF MONOCHROME LED STRIP CONTROL WITH RF.AMF AMPLIFIER

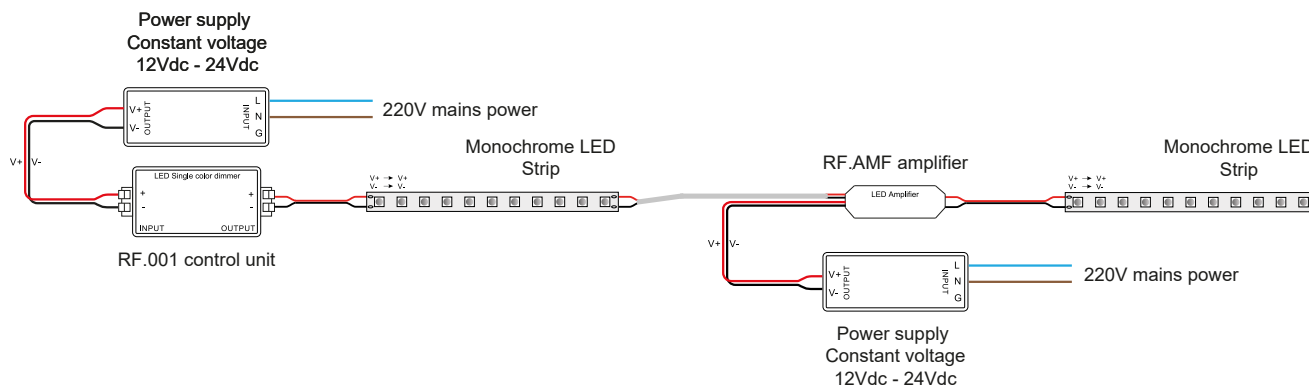

# SR-1029 control unit

Professional three-channel control unit for constant voltage 12Vdc or 24Vdc control of monochrome, dynamic white or RGB LED strips. Simple, intuitive pairing system between control units and radio remote controls. A remote control can be combined with several control units to expand the system Installation in unshielded indoor locations. Active memory function.

Power supply voltage:  $V_{in} = V_{out} - 12/24Vdc$

Output current:  $3 \times 5A - 12/24Vdc$

Power rating:  $3 \times 60W@12Vdc - 3 \times 120W@24Vdc$

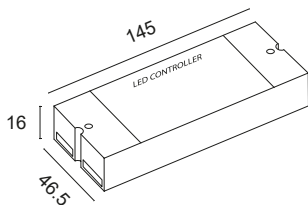

**SR-2839** **Radio remote control for monochrome LEDs**  
 Quick, precise light intensity selection and control via the round mini-touch panel.  
 Two pre-set scenes can be stored. Control of light intensity also via four preset buttons: 25%, 50%, 75% or 100%. Possibility of coupling the same radio control unit to several control units. Maximum operating distance 20 metres.

**SR-2839CCT** **Radio remote control for dynamic white LED**  
 Quick, precise colour temperature selection and adjustment via the mini round touch panel.  
 Light intensity adjustment via two buttons. Control of light intensity also via four preset buttons: 25%, 50%, 75% or 100%. Two pre-set scenes can be stored. Possibility of coupling the same radio control unit to several control units. Maximum operating distance 20 metres.

**SR-2839RGB** **Radio remote control for RGB LEDs**  
 Quick, precise colour selection and adjustment via the mini round touch panel.  
 Adjustment of light intensity of the chosen colour via a single button. Adjustment of light intensity of the primary colours via three buttons. Preset scene selection via single button. Possibility of adjusting the speed of scenes. Possibility of coupling the same radio remote control unit to several control units. Maximum operating distance 20 metres.

## EXAMPLE OF MONOCHROME LED STRIP CONTROL

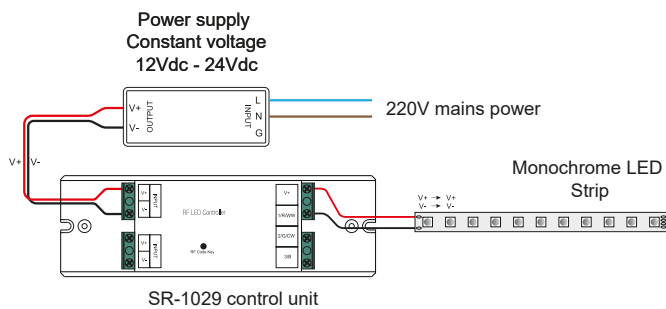

## EXAMPLE OF DYNAMIC WHITE LED STRIP CONTROL

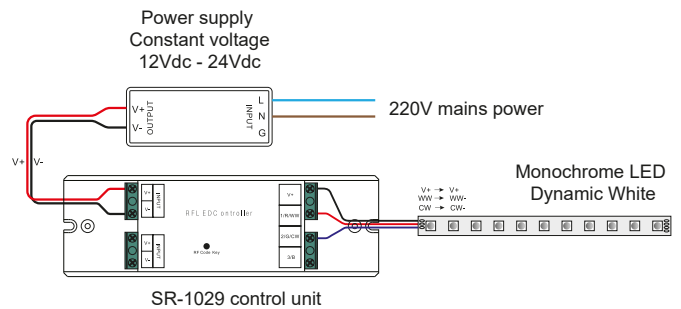

## EXAMPLE OF RGB LED STRIP CONTROL

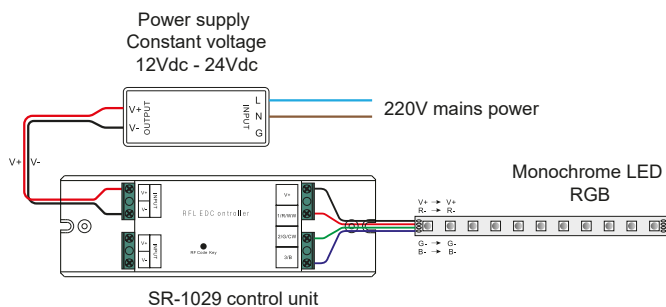

# RFL20K control unit

Three-channel control unit for 12Vdc or 24Vdc constant voltage control of RGB LED strips, radio remote control included. On/off function, dimmer, choice of colours, choice of scene speed and active memory. Possibility of expanding the system with up to nine RGB.AMF amplifiers. Installation in unshielded indoor locations.

Power supply voltage:  $V_{in} = V_{out} - 12/24Vdc$

Output current: 18A - 12/24Vdc

Power rating: 216W@12Vdc - 432W@24Vdc

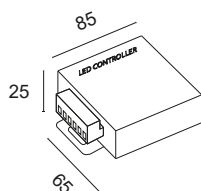

## EXAMPLE OF RGB LED STRIP CONTROL

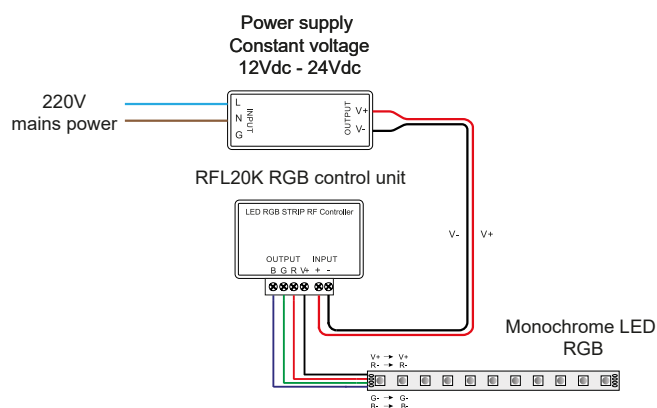

## EXAMPLE OF RGB LED STRIP CONTROL WITH AMPLIFIER

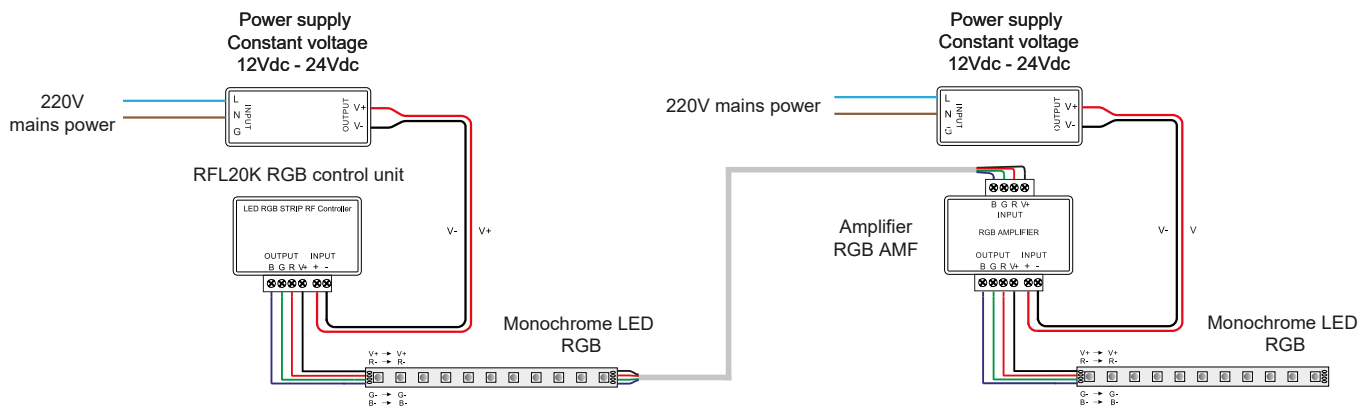

# SR-1029W control unit

Professional four-channel control unit for 24Vdc constant voltage control of RGBW LED strips. Simple, intuitive pairing system between control units and radio remote controls. A remote control can be combined with several control units to expand the system Installation in unshielded indoor locations. Active memory function.

Power supply voltage:  $V_{in} = V_{out} - 12/24Vdc$

Output current:  $3 \times 5A - 12/24Vdc$

Power rating:  $3 \times 60W @ 12Vdc - 3 \times 120W @ 24Vdc$

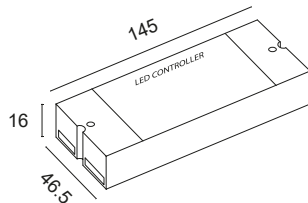

## SR-2839RGBW Radio remote control for RGBW LEDs



Quick, precise colour selection and adjustment via the mini round touch panel.

Adjustment of light intensity of the chosen colour via a single button.

Adjustment of light intensity of the primary colours via three buttons.

Two pre-set scenes can be stored.

Possibility of adjusting the speed of scenes.

Possibility of coupling the same radio remote control unit to several control units.

Maximum operating distance 20 metres.

## EXAMPLE OF RGBW LED STRIP CONTROL

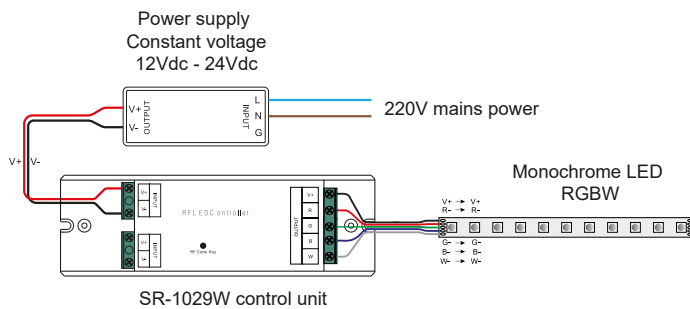

# SR-1009FA3 control unit

Professional four-channel control unit for 350mA constant current control of monochrome, dynamic white or RGB power LEDs. Simple, intuitive pairing system between control units and radio remote controls. A remote control can be combined with several control units to expand the system Installation in unshielded indoor locations. Active memory function.

Power supply voltage:  $V_{in} = V_{out} - 12/24Vdc$

Output current:  $4 \times 350mA - 12/24Vdc$

Power rating:  $4 \times 4.2W@12Vdc - 4 \times 8.4W@24Vdc$

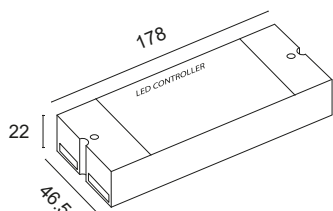

**SR-2819SDIM** Radio remote control for monochrome LEDs  
Quick, precise light intensity selection and control via the round mini-touch panel.  
Three pre-set scenes can be stored.  
Control of light intensity also via four preset buttons: 25%, 50%, 75% or 100%.  
Possibility of coupling the same radio remote control unit to several control units.  
Maximum operating distance 20 metres.



**SR-2819SCCT** Radio remote control for dynamic white LED  
Quick, precise colour temperature selection and adjustment via the mini round touch panel.  
Light intensity adjustment via two buttons.  
Control of light intensity also via four preset buttons: 25%, 50%, 75% or 100%.  
Three pre-set scenes can be stored.  
Possibility of coupling the same radio remote control unit to several control units.  
Maximum operating distance 20 metres.



**SR-2819S** Radio remote control for RGB LEDs  
Quick, precise colour selection and adjustment via the mini round touch panel.  
Adjustment of light intensity of the chosen colour via a single button.  
Adjustment of light intensity of the primary colours via three buttons.  
Preset scene selection via single button.  
Possibility of adjusting the speed of scenes.  
Possibility of coupling the same radio remote control unit to several control units.  
Maximum operating distance 20 metres.



## EXAMPLE OF MONOCHROME LED SPOT CONTROL

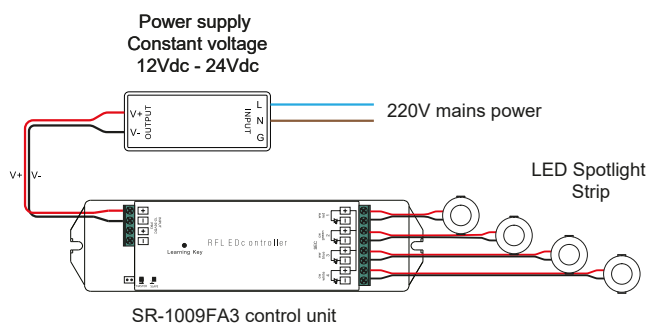

## EXAMPLE OF DYNAMIC WHITE LED SPOTLIGHTS

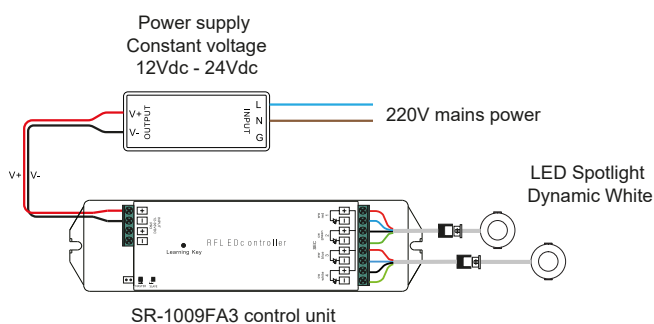

## EXAMPLE OF RGB LED SPOTLIGHT CONTROL

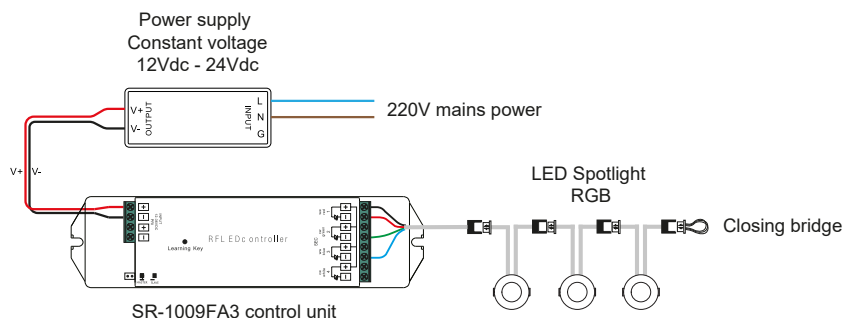



# DLM1224-1CV control unit

One-channel control unit with ON/OFF and DIMMER function in 12Vdc or 24Vdc constant voltage for monochrome LEDs. Control via a normally open button, 0-10V / 1-10V signal or potentiometer. The system can be expanded with the use of additional control units. Can be installed in unshielded indoor environments.

Active memory function.

Power supply voltage:  $V_{in} = V_{out} - 12/24Vdc$

Output current: 10A - 12/24Vdc

Power rating: 120W@12Vdc - 240W@24Vdc

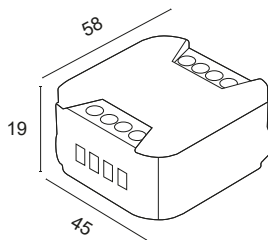

## EXAMPLE OF MONOCHROME LED STRIPS CONTROL

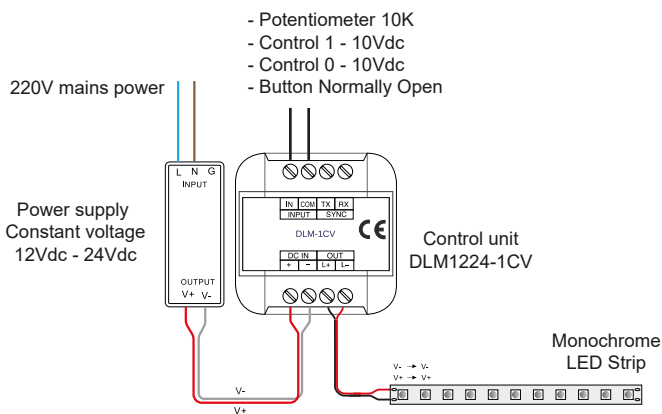

## EXAMPLE OF MONOCHROME LED STRIP CONTROL WITH AMPLIFIER

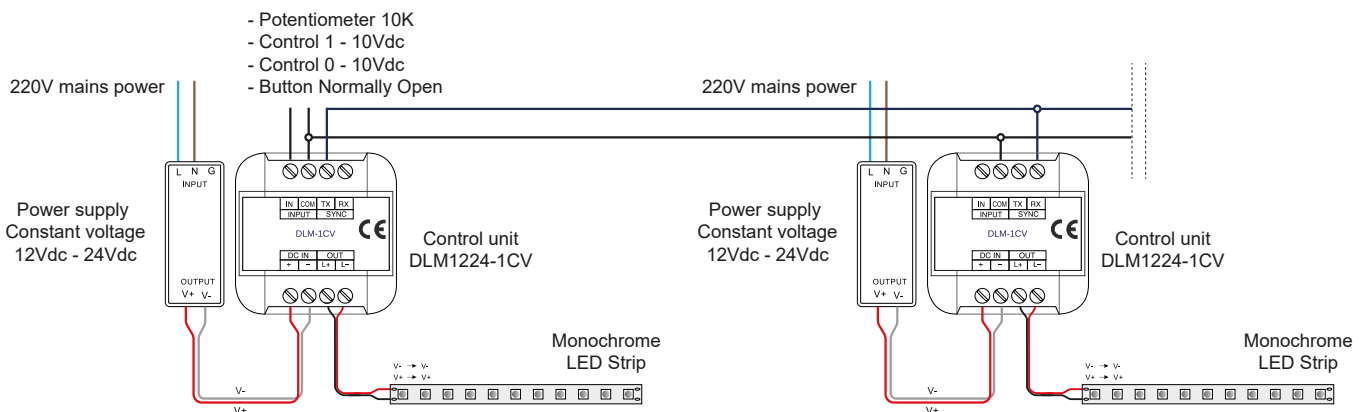

# MINI-1CV control unit

One-channel control unit with ON/OFF and DIMMER function in 12Vdc or 24Vdc constant voltage for monochrome LEDs. Control via a normally open button, 0-10V / 1-10V signal or potentiometer. The system can be expanded with the use of additional control units. Can be installed in unshielded indoor environments.

Active memory function. Using the LightApp mobile application, it is possible to configure the dimming frequency, dimming curve, brightness level and dynamic scenarios or animations.

Power supply voltage:  $V_{in} = V_{out} - 12/24Vdc$

Output current: 12A - 12/24Vdc

Power rating: 144W@12Vdc - 288W@24Vdc

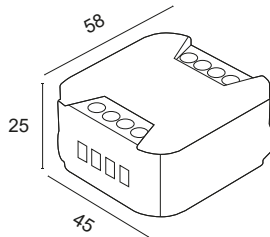

## EXAMPLE OF MONOCHROME LED STRIPS CONTROL

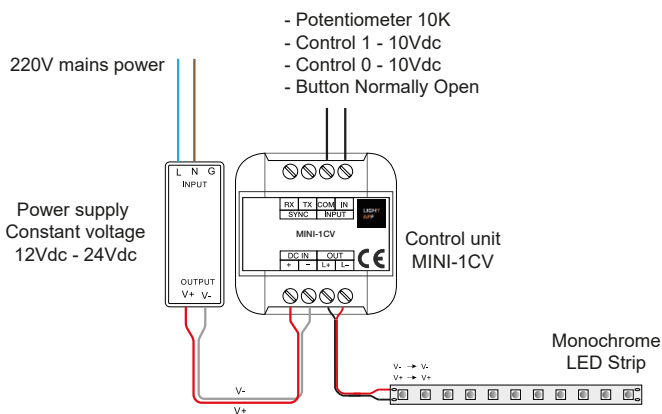

## EXAMPLE OF MONOCHROME LED STRIP CONTROL WITH AMPLIFIER

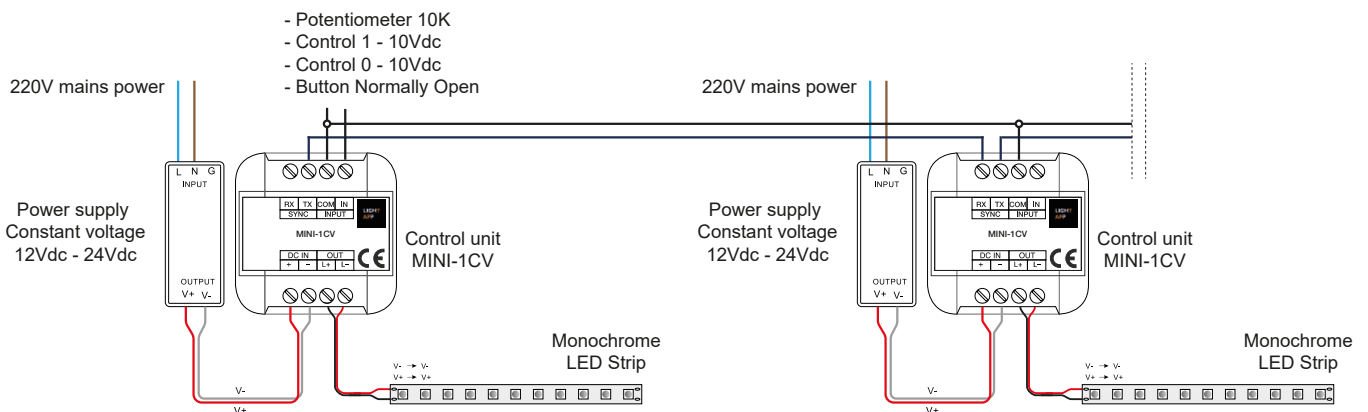

# MINI-1CV-DALI control unit

One-channel control unit with ON/OFF and DIMMER function in 12Vdc or 24Vdc constant voltage for monochrome LEDs. DALI control system via a normally open button, 0-10V / 1-10V signal or potentiometer. Can be installed in unshielded indoor environments. Active memory function. Using the LightApp mobile application, it is possible to configure the dimming frequency, dimming curve, brightness level and dynamic scenarios or animations.

Power supply voltage:  $V_{in} = V_{out} - 12/24Vdc$

Output current: 10A - 12/24Vdc

Power rating: 120W@12Vdc - 240W@24Vdc

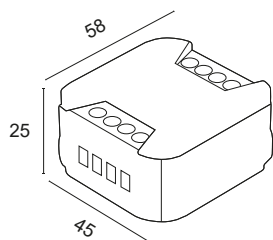

## EXAMPLE OF MONOCHROME LED STRIPS CONTROL

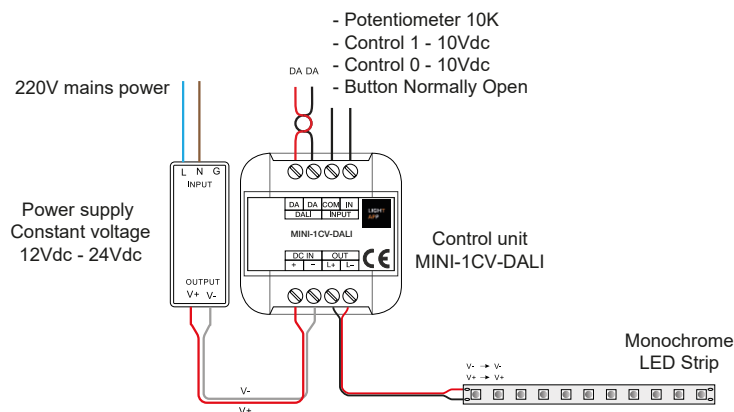

# MINI-1CV-CASAMBI control unit

One-channel control unit with ON/OFF and DIMMER function in 12Vdc or 24Vdc constant voltage for monochrome LEDs. CASAMBI control system or via a normally open button. Can be installed in unshielded indoor environments. Active memory function. Using the CASAMBI application, it is possible to make simple brightness adjustments right up to more complex lighting control systems, thanks to the creation of multiple scenes, animations, timers, daylight controls, etc.

Power supply voltage:  $V_{in} = V_{out} - 12/24Vdc$

Output current: 12A - 12/24Vdc

Power rating: 144W@12Vdc - 288W@24Vdc

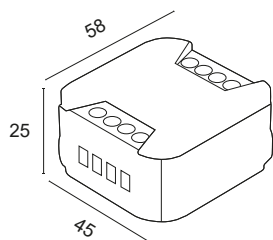

MINI-1CV-CASAMBI



## EXAMPLE OF MONOCHROME LED STRIPS CONTROL

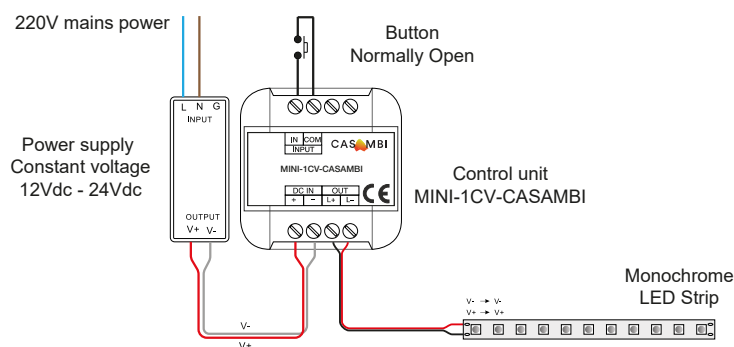

# LINE-5CV control unit

Five-channel control unit with ON/OFF and DIMMER function in 12Vdc or 24Vdc constant voltage for monochrome, dynamic white, RGB or RGBW LEDs. Control system via two normally open buttons. Can be installed in unshielded indoor environments. The system can be expanded with the use of the DLA-1224-4CV amplifier.

Active memory function.

Power supply voltage:  $V_{in} = V_{out} - 12/24/48Vdc$

Output current: 12A - 12/24/48Vdc

Power rating: 144W@12Vdc - 288W@24Vdc - 576W@48Vdc

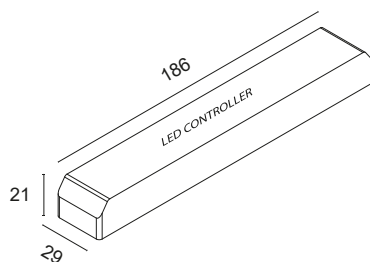

## EXAMPLE OF RGBW LED STRIP CONTROL

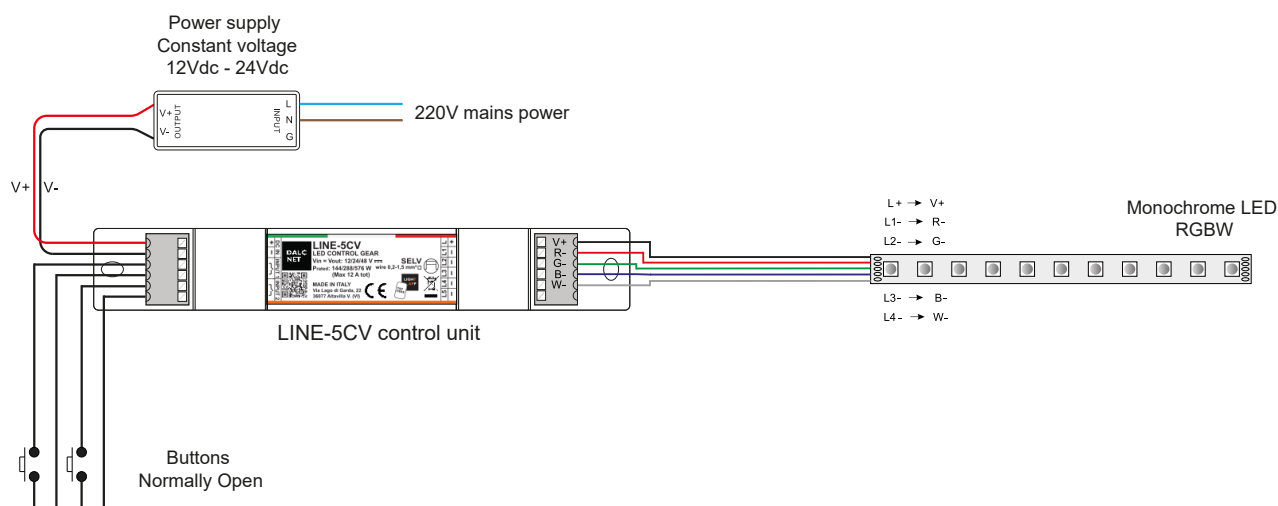



# DLX1224-4CV-DALI control unit

Four-channel control unit with ON/OFF and DIMMER function in 12Vdc or 24Vdc constant voltage for monochrome, dynamic white, RGB or RGBW LEDs. DALI control system or via DIP-SWITCH. Can be installed in unshielded indoor environments. The system can be expanded with the use of the DLA-1224-4CV amplifier. Active memory function.

Power supply voltage:  $V_{in} = V_{out} - 12/24Vdc$

Output current: 10A - 12/24Vdc

Power rating: 120W@12Vdc - 240W@24Vdc

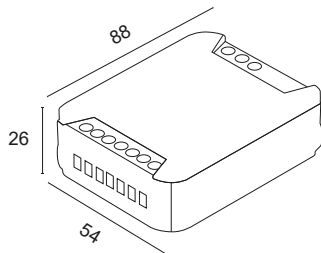

DLX1224-4CV-DALI



DLA1224-4CV



## EXAMPLE OF RGBW LED STRIP CONTROL

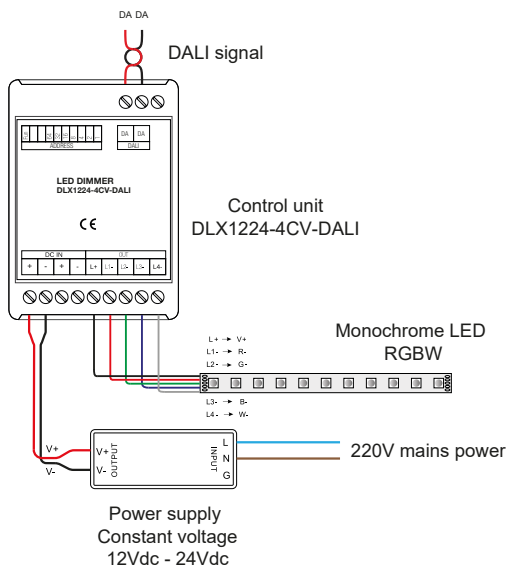

## EXAMPLE OF RGBW LED STRIP CONTROL WITH AMPLIFIER

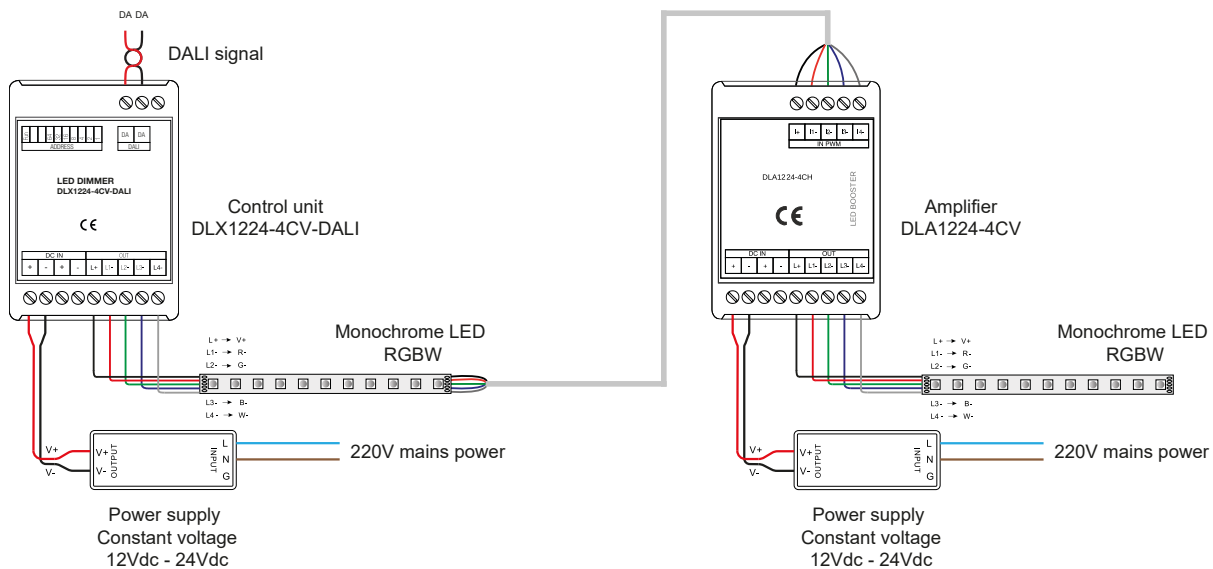

# LINE 5CV-CASAMBI CONTROL UNIT

Five-channel control unit with ON/OFF and DIMMER function in 12Vdc or 24Vdc constant voltage for monochrome, dynamic white, RGB or RGBW LEDs. Control system via two normally open buttons. Can be installed in unshielded indoor environments. The system can be expanded with the use of the DLA-1224-4CV amplifier. Active memory function. Using the CASAMBI application, it is possible to make simple brightness adjustments right up to more complex lighting control systems, thanks to the creation of multiple scenes, animations, timers, daylight controls, etc.

Power supply voltage:  $V_{in} = V_{out} - 12/24/48Vdc$

Output current: 12A - 12/24/48Vdc

Power rating: 144W@12Vdc - 288W@24Vdc - 576W@48Vdc

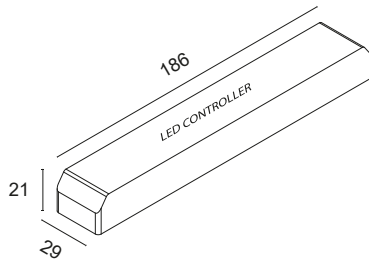

## EXAMPLE OF RGBW LED STRIP CONTROL

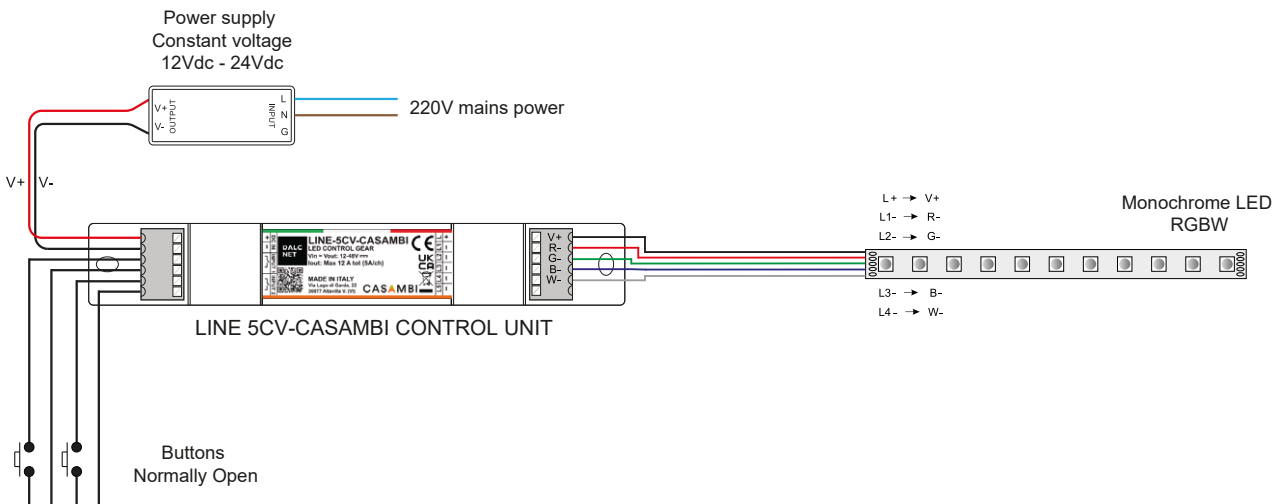

# DLC1248-1CC350 control unit

# DLC1248-1CC500 control unit

One-channel control unit with ON/OFF and DIMMER function for 350mA or 500mA constant voltage monochrome LEDs. control system via a normally open button. Possibility to expand the system with the use of DLA1248-1CC350 or DLA1248-1CC500 amplifiers. Can be installed in unshielded indoor environments. Memory function possible.

Power supply voltage:  $V_{in} = 24Vdc$

Output current: 350mA - 500mA

Power rating: 8.4W@350mA Total - 12W@500mA Total

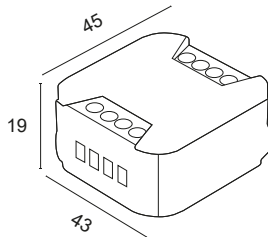

DLC1248-1CC350  
DLC1248-1CC500



DLA1248-1CC350  
DLA1248-1CC500



## EXAMPLE OF MONOCHROME LED SPOTLIGHT CONTROL

- Connected to 5V = MEMORY
- Connected to 5V = NO MEMORY

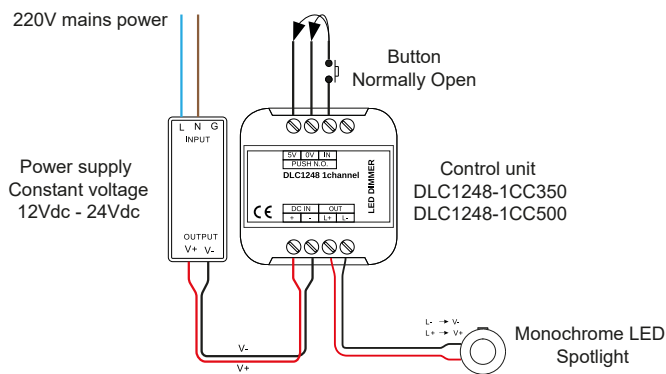

## EXAMPLE OF MONOCHROME LED SPOTLIGHT CONTROL WITH AMPLIFIER

- Connected to 5V = MEMORY
- Connected to 5V = NO MEMORY

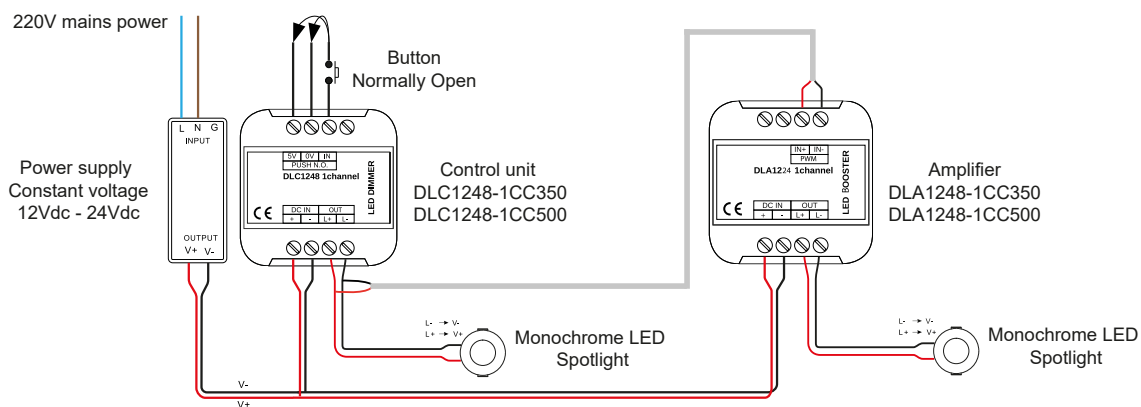

# DLX1224-4CC350 control unit

# DLX1224-4CC500 control unit

Four-channel control unit with ON/OFF and DIMMER function for 350mA or 500mA constant voltage RGB LEDs. Control system via two normally open buttons. Possibility to expand the system with the use of DLA1224-4CC350 or DLA1224-4CC500 amplifiers. Can be installed in unshielded indoor environments. Memory function possible.

Power supply voltage:  $V_{in} = 24Vdc$

Output current: 350mA - 500mA

Power rating: 33.6W@350mA Total - 48W@500mA Total

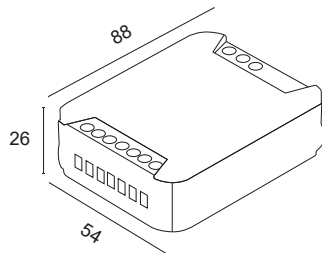

DLX1224-4CC350  
DLX1224-4CC500



DLA1224-4CC350  
DLA1224-4CC500



## EXAMPLE OF RGB LED SPOTLIGHT CONTROL

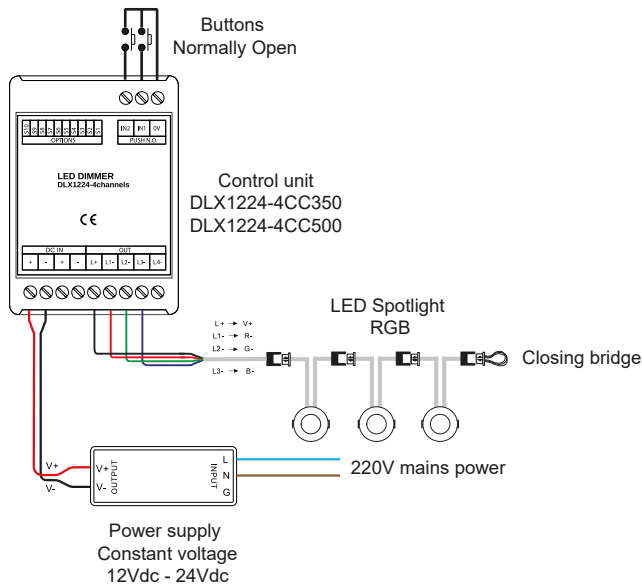

## EXAMPLE OF RGB LED SPOTLIGHT CONTROL WITH AMPLIFIER

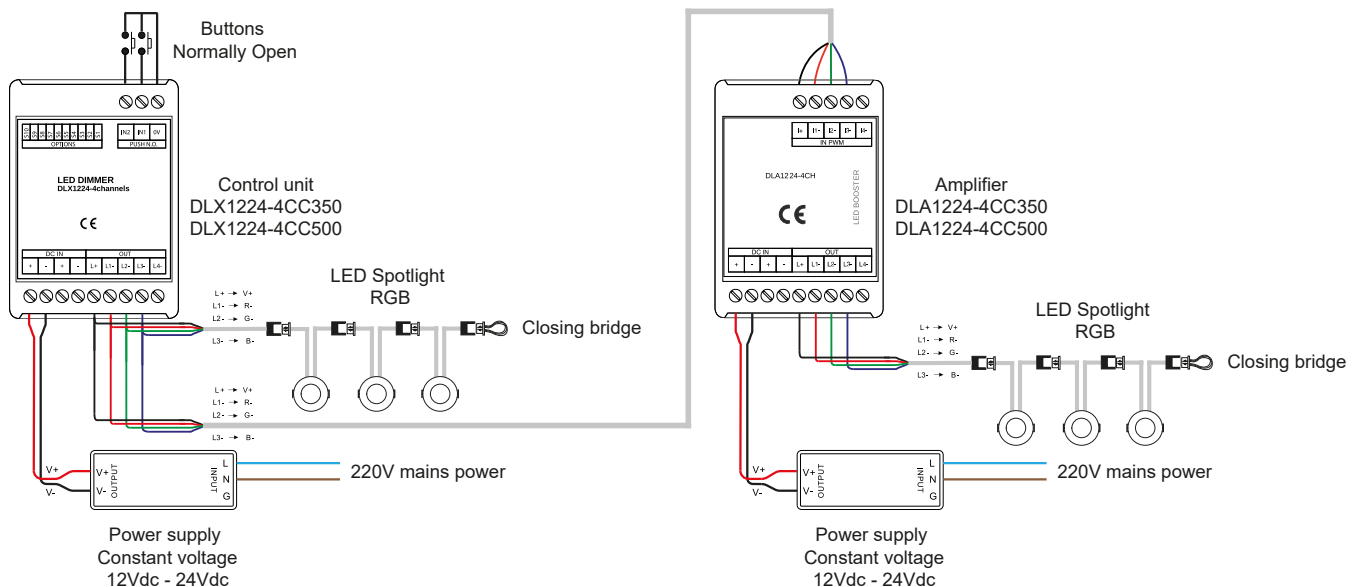

# VOLUMETRIC SENSOR

Electronic device for switching the constant voltage LED on and off. Up to a maximum distance of 3m and at an angle of 120°, the SENSOR system detects a presence through movement and switches on the LED; if there is no movement, the system will switch off the LED after approximately 30 seconds. Supplied tested and wired in three solutions: pcb only, pcb mounted on flush mount, pcb mounted on ceiling mount.

Power supply voltage:  $V_{in} = V_{out} - 12/24Vdc$

Output current: 4A - 12/24Vdc

Power rating: 48W@12Vdc - 96W@24Vdc

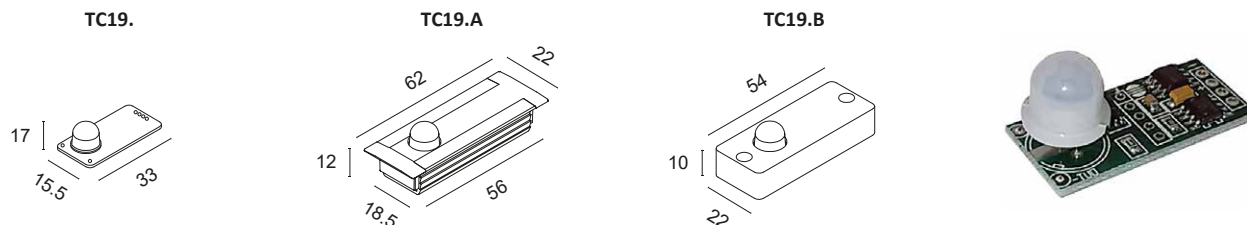

# INFRARED SENSOR

Electronic device for switching the constant voltage LED on and off. The IR system will switch the LED on or off with hand movement up to a maximum distance of 10cm. Supplied tested and wired in three solutions: pcb only, pcb mounted on flush mount, pcb mounted on ceiling mount.

Power supply voltage:  $V_{in} = V_{out} - 12/24Vdc$

Output current: 4A - 12/24Vdc

Power rating: 48W@12Vdc - 96W@24Vdc

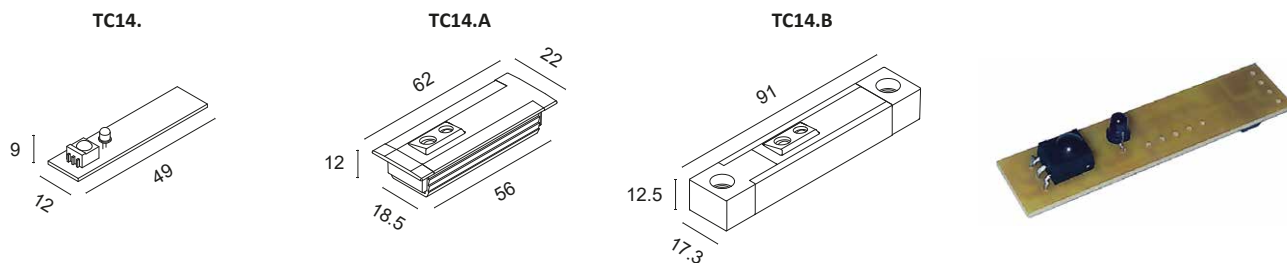

# TOUCH SENSOR

Electronic device for switching the constant voltage LED on and off. The TOUCH system will switch the LED on or off with a light touch of the hand. Supplied tested and wired in three solutions: pcb only, pcb mounted on flush mount, pcb mounted on ceiling mount.

Power supply voltage:  $V_{in} = V_{out} - 12/24Vdc$

Output current: 4A - 12/24Vdc

Power rating: 48W@12Vdc - 96W@24Vdc

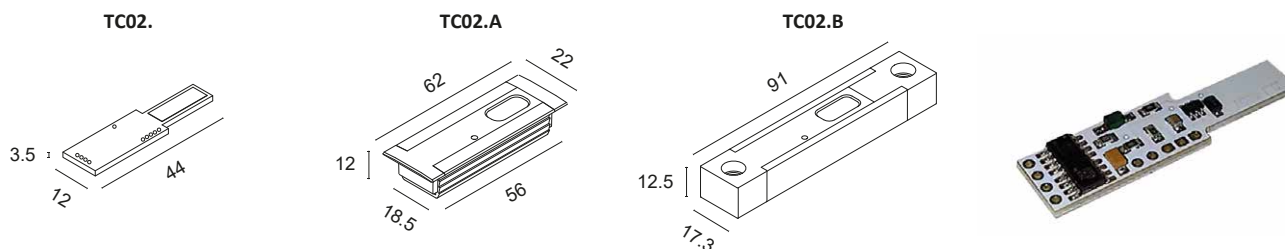



# TOUCH MINI SENSOR

Electronic device for switching the constant voltage LED on and off. The TOUCH system will switch the LED on or off with a light touch of the hand. Supplied only pcb tested and wired.

Power supply voltage:  $V_{in} = V_{out} - 12/24Vdc$

Output current: 3A - 12/24Vdc

Power rating: 48W@12Vdc - 96W@24Vdc

TC22.

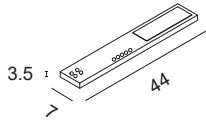

---

# TOUCH DIMMER SENSOR

Electronic device for adjusting and switching the constant voltage LED on and off. The TOUCH system switches the LED on or off with a light touch of the hand. Lightly pressing the DIMMER system will increase or decrease the light intensity. Supplied tested and wired in three solutions: pcb only, pcb mounted on flush mount, pcb mounted on ceiling mount.

Power supply voltage:  $V_{in} = V_{out} - 12/24Vdc$

Output current: 4A - 12/24Vdc

Power rating: 48W@12Vdc - 96W@24Vdc

TC20.

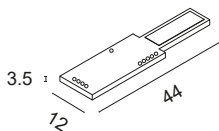

TC20.A

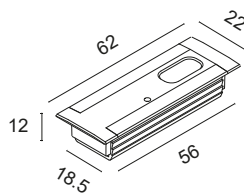

TC20.B

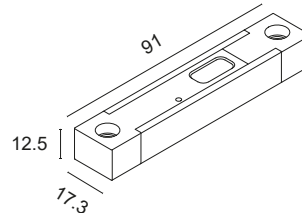

# MINI MOTION DETECTOR

Electronic device for switching on and off via the volumetric sensor. The controller turns on the switch when body movement is detected within its range. The switch switches off after the time set in the controller's timer has elapsed. Set the desired timing on the potentiometer. The switch-on time can be set from 10sec. to 3 minutes.

Power supply voltage:  $V_{in} = V_{out} - 100/240Vac$

Power rating: Max 250W

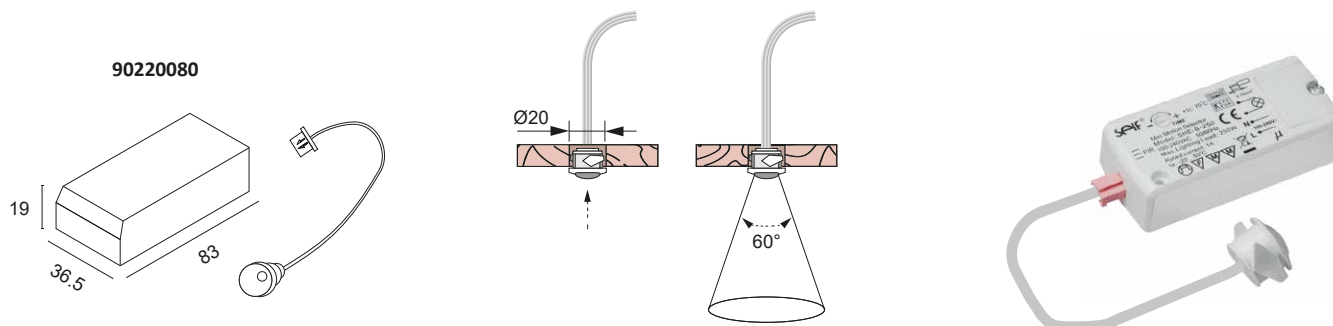

# TOUCH SENSOR SWITCH

Electronic device for switching on and off via the TOUCH system. The device turns by lightly touching the sensitive surface connected to the controller's touch sensor. The device's sensitivity is preset to a mid-range; it can be adjusted by turning the potentiometer on the side of the device.

Power supply voltage:  $V_{in} = V_{out} - 220/240Vac$

Power rating: Max 500W

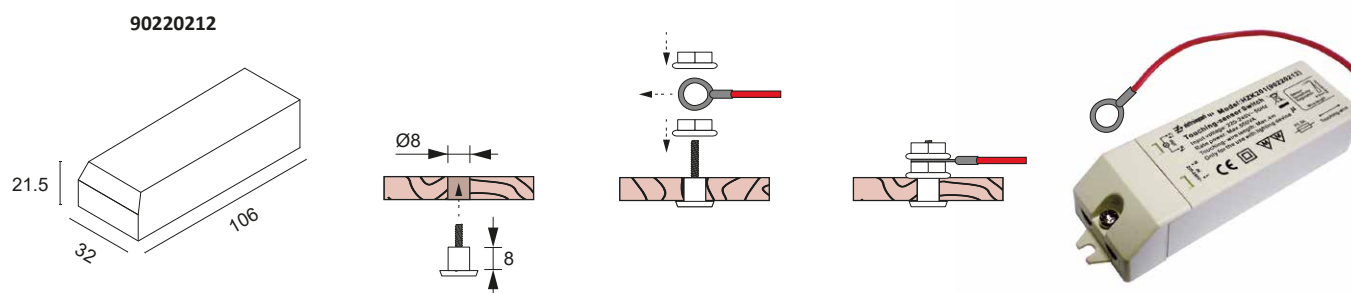

# IR SENSOR SWITCH

Electronic device for switching on and off via the INFRARED system. The sensor reacts to approaching objects or hands. The IR sensor controller switches on when it detects a body in its range and switches off when a body is detected again.

Power supply voltage:  $V_{in} = V_{out} - 100/240Vac$

Power rating: Max 250W

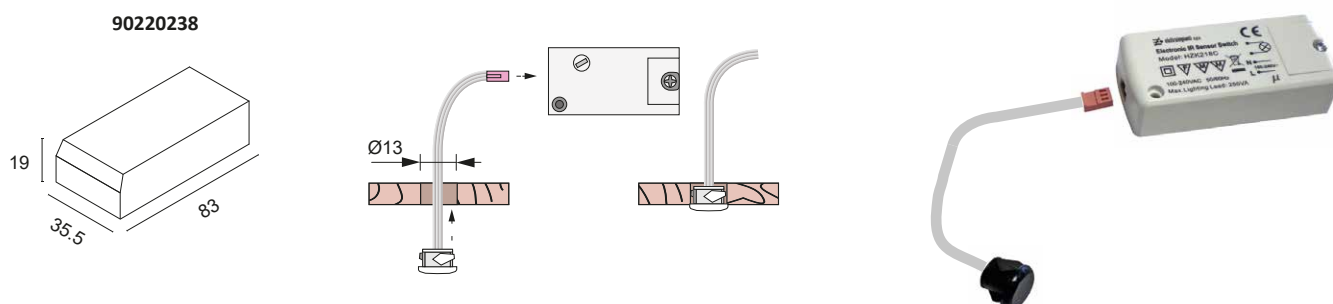



## **INSTALLATION ACCESSORIES**

<b>HOLLY, HALISSA AND MEMO FORMWORK</b> .....	270
<b>ACSO AND ACRUX SERIES FORMWORK</b> .....	270
<b>ACSO AND ACRUX SERIES RING</b> .....	270
<b>DEHO AND DARDO FORMWORK</b> .....	271
<b>DEHO AND DARDO SERIES RING</b> .....	271
<b>PAD FORMWORK</b> .....	271
<b>REMOVE PLUS FORMWORK</b> .....	272
<b>REMOVE MINUS FORMWORK</b> .....	272
<b>DUVAR BASE AND STAKE</b> .....	272

# HOLLY, HALISSA AND MEMO FORMWORK

Thermoplastic formwork for HOLLY, HALISSA and MEMO series models for use during installation. Can be installed in brick walls or floors. Necessary for correct installation.

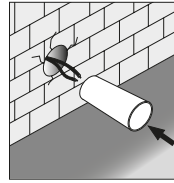
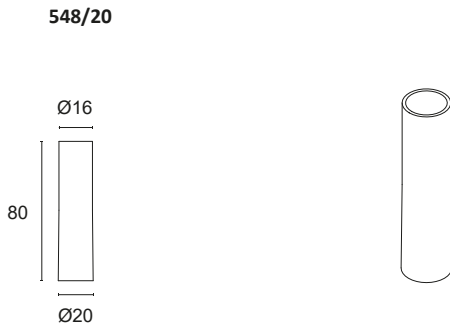

Position the formwork flush with the wall or floor.

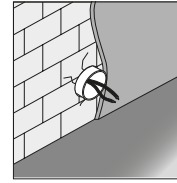

Fix the formwork with glue or putty and level it flush with the wall or floor. Prevent foreign bodies from entering the formwork.

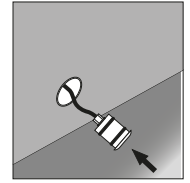

Connect the electricals as stipulated in the product sheet and check it works correctly. Insert the product into the formwork using light pressure.

## ACSO AND ACRUX SERIES FORMWORK

Thermoplastic formwork for ACSO and ACRUX series models for use during installation. Can be installed in brick walls or floors. Necessary for correct installation.

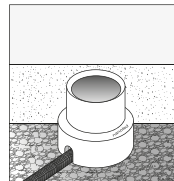
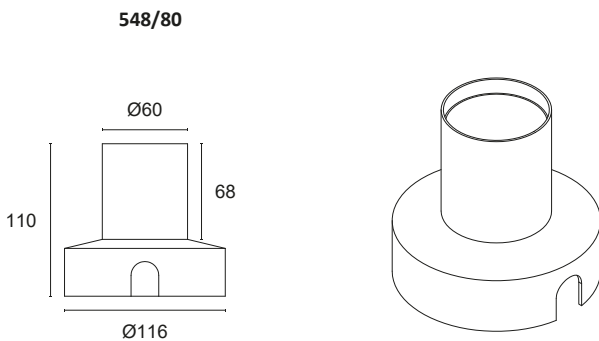

Position the formwork with the top flush with the wall or floor. Apply the supplied cap to prevent foreign bodies from entering the interior. Make sure there is adequate drainage under the formwork.

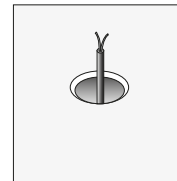

Check that the formwork does not move when laying the screed. Route the electrical cable from the formwork to the shaft. Close the formwork with the cap provided.

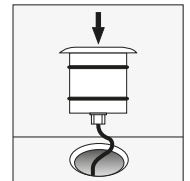

After plastering, remove the cap and connect the electricals according to the product sheet, check that it works properly and insert it into the formwork with light pressure.

## ACSO AND ACRUX SERIES RING

Aluminium ring for ACSO and ACRUX series models for use during flush fitting in plasterboard.

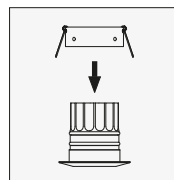
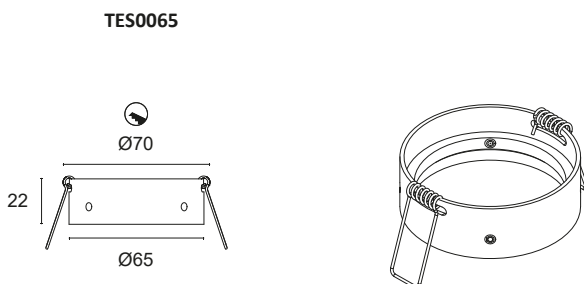

Place the ring in the spotlight.

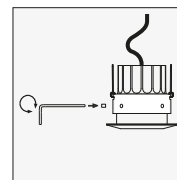

Secure the ring with the supplied grub screws.

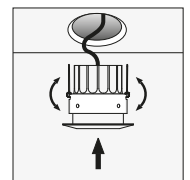

Drill the plasterboard to the indicated size and insert the spotlight into the hole.



# DEHO AND DARDO FORMWORK

Thermoplastic formwork for DEHO and DARDO series models for use during installation. Can be installed in brick walls or floors. Necessary for correct installation.

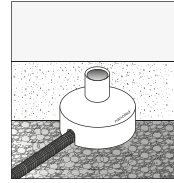
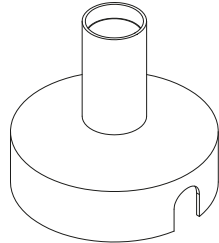
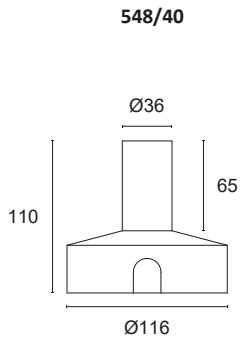

Position the formwork with the top flush with the wall or floor. Apply the supplied cap to prevent foreign bodies from entering the interior. Make sure there is adequate drainage under the formwork.

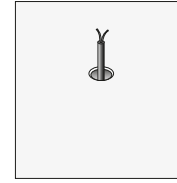

Check that the formwork does not move when laying the screed. Route the electrical cable from the formwork to the shaft. Close the formwork with the cap provided.

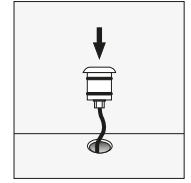

After plastering, remove the cap and connect the electricals according to the product sheet, check that it works properly and insert it into the formwork with light pressure.

# DEHO AND DARDO SERIES RING

Aluminium ring for DEHO and DARDO series models for use during flush fitting in plasterboard.

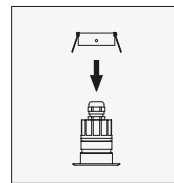
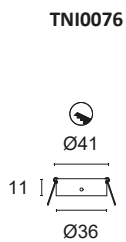

Place the ring in the spotlight.

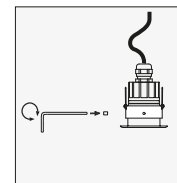

Secure the ring with the supplied grub screws.

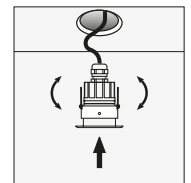

Drill the plasterboard to the indicated size and insert the spotlight into the hole.

# PAD FORMWORK

Metal formwork for the PAD model for use during installation. Can be wall mounted on stone, brick or plasterboard. Necessary for correct installation.

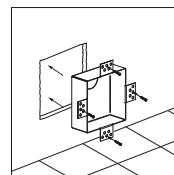
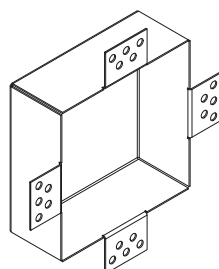
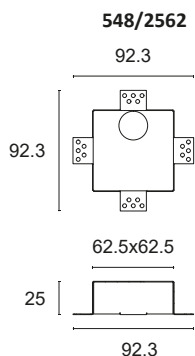

Insert the housing for the formwork and fix it with glue, putty or screws.

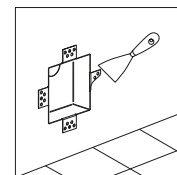

Finish off the edges of the formwork and prevent foreign bodies from entering the formwork. Route the electrical cable from the formwork to the shaft or to the shunt box.

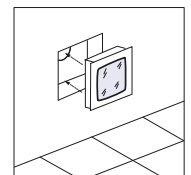

Connect the electricals according to the product sheet, check that it works properly and insert it into the formwork using light pressure.

# REMOVE PLUS FORMWORK

Metal formwork for the REMOVE PLUS model for use during installation. Can be wall mounted on stone, brick or plasterboard. Necessary for correct installation.

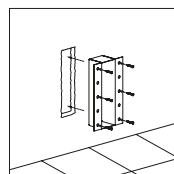
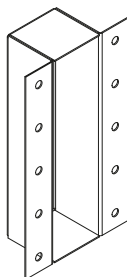
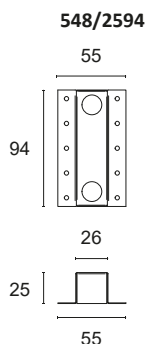

Insert the housing for the formwork and fix it with glue, putty or screws.

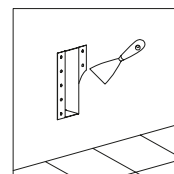

Finish off the edges of the formwork and prevent foreign bodies from entering the formwork. Route the electrical cable from the formwork to the shaft or to the shunt box.

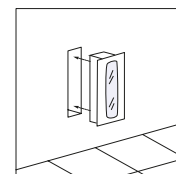

Connect the electricals according to the product sheet, check that it works properly and insert it into the formwork using light pressure.

# REMOVE MINUS FORMWORK

Metal formwork for the REMOVE MINUS model for use during installation. Can be wall mounted on stone, brick or plasterboard. Necessary for correct installation.

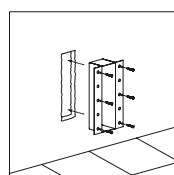
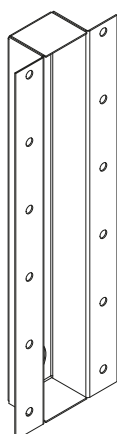
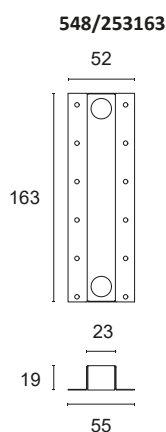

Insert the housing for the formwork and fix it with glue, putty or screws.

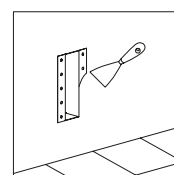

Finish off the edges of the formwork and prevent foreign bodies from entering the formwork. Route the electrical cable from the formwork to the shaft or to the shunt box.

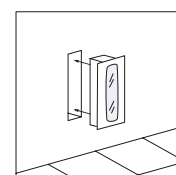

Connect the electricals according to the product sheet, check that it works properly and insert it into the formwork using light pressure.

# DUVAR BASE AND STAKE

Mounting systems for DUVAR projector, necessary for correct installation.

TES0039

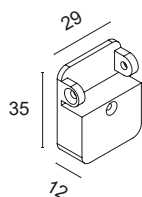

Fixing base

Box

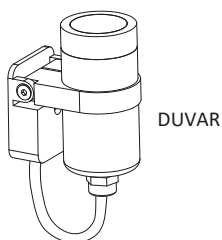

DUVAR

PDH235

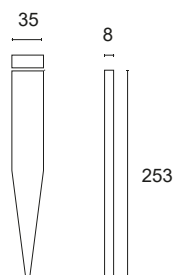

Fixing stake

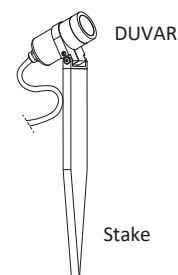

Stake







## COMPLEMENTARY SYSTEMS

REM COMPLEMENTARY SYSTEMS .....	276
DARK COMPLEMENTARY SYSTEMS .....	276



# COMPLEMENTARY SYSTEMS REM

Ø32mm anodised aluminium directional projector decorated with CRI>90 LEDs for spot, decorative or courtesy lighting. Choice of secondary optics, can be installed indoors, with concealed faceplate on Delta or Kappa pendant, Delta or Kappa flush ceiling light, or flush-mounted Delta or Tau.

N.B. positioning, switch on management and other details to be defined in the order.

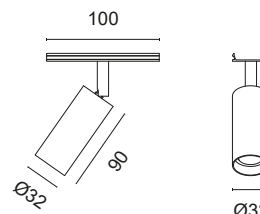
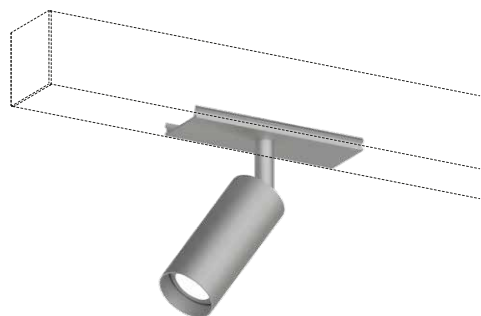

## BASIC CODES

**RG1.**

## FINISHES

- 1 White
- 2 Matt black
- 7 Brushed aluminium
- 9 Polished gold

## LIGHT BEAM

- 15 15°
- 25 25°
- 35 35°

## LED COLOUR

- BN** 4000K
- BC** 3000K
- CC** 2700K
- BL** Blue
- VE** Green
- RO** Red
- AM** Amber

## POWER

- 3** 1x2W  
500mA - 216 lm
- 5** 3x2W  
500mA - 648 lm

### Code example:

REM + White + Light Beam 15° + 4000K + 2W = Code: RG1.115BC3

# DARK

320mm anodised aluminium module decorated with 14 high-efficiency CRI>90 LEDs for spot, decorative or courtesy lighting. Choice of secondary optics, can be installed indoors, with flush-mounted faceplate on Delta or Kappa pendant, Delta or Kappa flush ceiling light, or flush-mounted Delta or Tau.

N.B. positioning, switch on management and other details to be defined in the order.

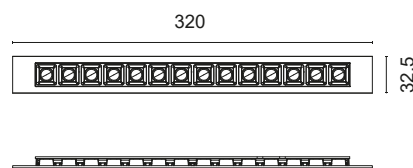
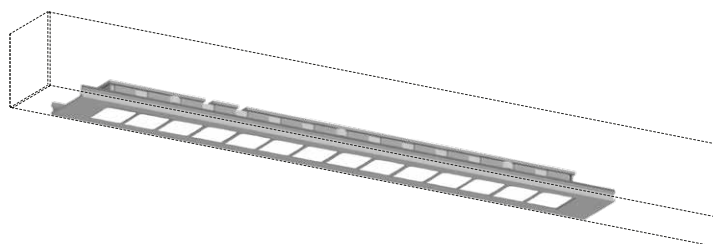

## BASIC CODES

**DK14.**

## FACEPLATE FINISH

- 1 White
- 2 Matt black
- 7 Brushed aluminium

\*Other finishes on request.

## LIGHT BEAM

- 30 30°
- 55 55°
- 65 65°

## LED COLOUR

- BN** 4000K
- BC** 3000K
- CC** 2700K

## POWER

- 1 7.2W**  
**24Vdc - 780 lm**

### Code example:

DARK + White + Light Beam 30° + 4000K + 7.2W = Code: DK14.130BN1





## **NANOLED LIGHTING**

It is a brand of Tecnocavi Service srl  
61021 Carpegna (PU) via Pian dei Roghi, 32  
Tel. + 39 0722 77418  
[www.nanoledlighting.com](http://www.nanoledlighting.com)

## **CONTACTS**

### **Information office**

[info@nanoledlighting.com](mailto:info@nanoledlighting.com)

### **Federico Francioni**

Owner and Sales Manager  
[federico@nanoledlighting.com](mailto:federico@nanoledlighting.com)

### **Francesco Francioni Jr.**

Italy Sales  
[commerciale@nanoledlighting.com](mailto:commerciale@nanoledlighting.com)

### **Fabrizio Francioni**

Owner and Production and Procurement Manager  
[fabrizio@nanoledlighting.com](mailto:fabrizio@nanoledlighting.com)

### **Francesco Francioni**

Owner and General Management  
[francesco@nanoledlighting.com](mailto:francesco@nanoledlighting.com)

### **Francesca Severi**

Head of Administration  
[amministrazione@nanoledlighting.com](mailto:amministrazione@nanoledlighting.com)

### **Remo Giuliani**

Technical and design office  
[tecnico@nanoledlighting.com](mailto:tecnico@nanoledlighting.com)

## **2025 LIGHTING CATALOGUE Ed. 02**

Graphic design and realisation: Team Nanoled Lighting

**Tecnocavi Service S.r.l.** accepts no liability for printing errors, measurements and technical data. The company reserves the right to make changes to the products illustrated, at any time, without prior notice. Unauthorised reproduction or copying is prohibited.





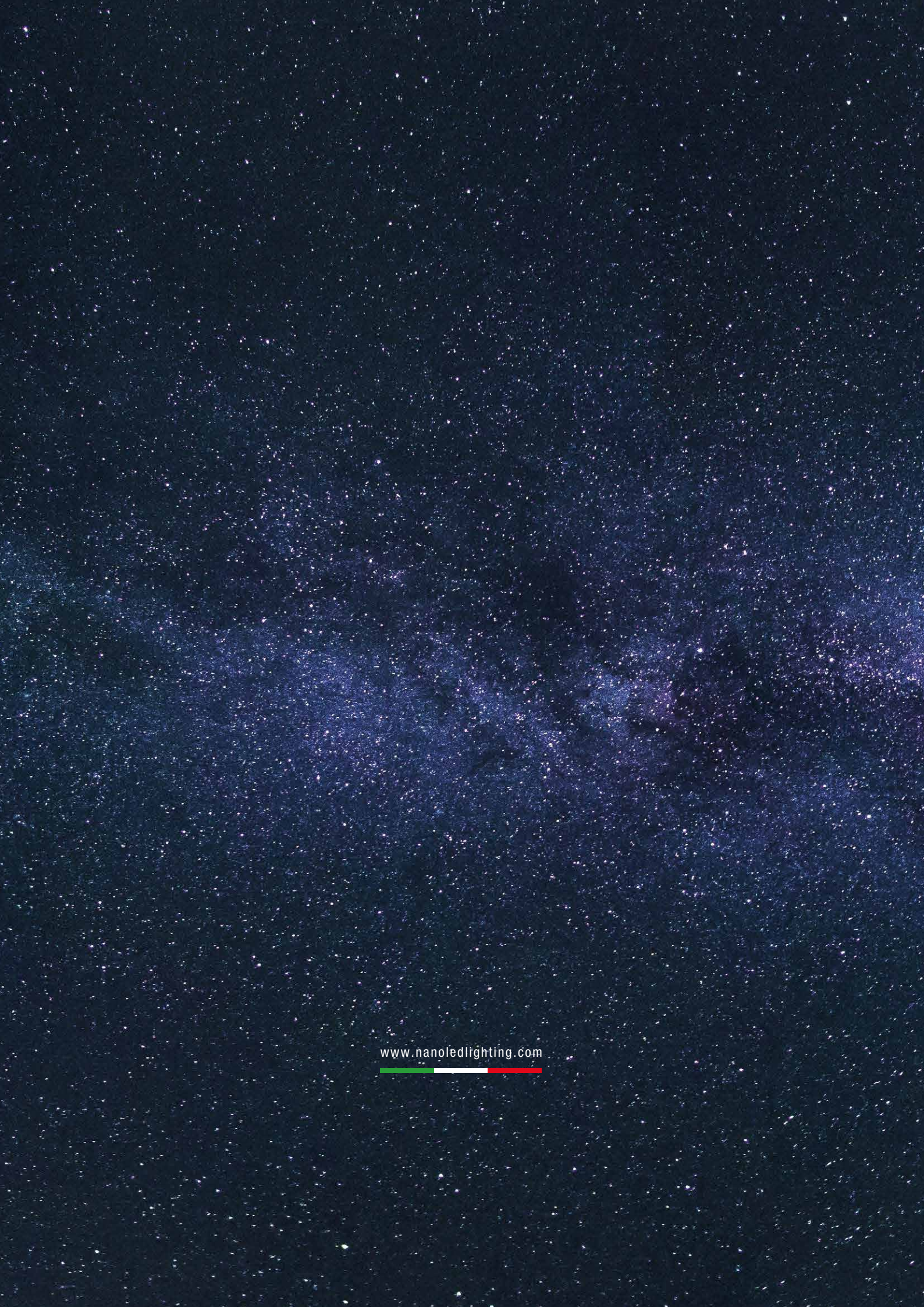

[www.nanoledlighting.com](http://www.nanoledlighting.com)

