

Collezione  
Vino e Champagne



PAUL P. TO MEIN



*Paul P. To Mein*

III

ARLBERG, ENOANOE

*und Co. in Wien*

1819

*Wine and Champagne*

1819







**NANOLED LIGHTING**

È un brand di Tecnocavi Service srl  
61021 Carpegna (PU) via Pian dei Roghi, 32  
Tel. + 39 0722 77418  
[info@nanoledlighting.com](mailto:info@nanoledlighting.com)  
[www.nanoledlighting.com](http://www.nanoledlighting.com)

NANOLED LIGHTING ha dedicato all'affascinante mondo dello champagne e del vino una serie di prodotti specifici ed approvati per la corretta conservazione. Da sempre l'esposizione alla luce condiziona la vita del vino, dalla sua nascita, sui filari, fino alla bottiglia. Lo spettro luminoso interagisce direttamente con tutte le cellule e gli atomi che compongono la materia. Questo processo si innesca sia con la luce visibile, che sono i colori dello spettro che vediamo, sia con quella invisibile di cui fanno parte gli UV (ultravioletti) che gli IR (infrarossi).

Sin dall'antichità l'umanità sa che una esposizione prolungata del vino alla luce è nociva ed i metodi di conservazione hanno tenuto sempre conto di questo aspetto. Si utilizzavano anfore chiuse, magari sotterrate o tenute in cantina, come ora. Molto ampio è anche lo studio del colore delle bottiglie, ne esistono trasparenti, gialle, verdi e ambra. Questo significa che la conoscenza e la tecnica hanno fatto tanti passi avanti e la qualità dei vini proposti è aumentata molto perciò si sono studiate soluzioni innovative nella produzione, nella distribuzione e nella conservazione.

Importanti studi di enologi e specialisti hanno evidenziato un difetto che emerge quando i vini, soprattutto bianchi o rosé, prodotti con metodo classico o champenoise sono esposti alla luce. Questo fenomeno è anche noto come "Gusto di Luce" o "Goût de Lumière" in francese e conferisce allo champagne e al vino un odore e un retrogusto sgradevole che sa di lana o cavolo bollito. La causa è appunto l'alterazione della riboflavina e degli aminoacidi presenti nel vino esposto alla luce che compromette il sapore di importanti prodotti della zona del Collio, della Franciacorta, delle Langhe Piemontesi e soprattutto i vini francesi della zona di produzione dello Champagne (Montagne de Reims, Côte des Bancs, Vallée de la Marne, Côte de Sézanne e Aube).

L'unica soluzione è prevenire il "Gusto di Luce" attraverso una corretta conservazione in cantine o sale adeguatamente illuminate. Attraverso i suoi "LED AMBRA VINO" NANOLED LIGHTING ha ottenuto dal Comitato Interprofessionale dei Vini di Champagne (CIVIC) l'unica approvazione riconosciuta idonea per questo scopo. Il comitato ha infatti certificato che i nostri "LED AMBRA VINO" escludono totalmente lo spettro fotometrico dannoso al vino.

NANOLED LIGHTING ha selezionato una raccolta di prodotti da inserire in progetti ed installazioni specifiche e soprattutto corrette per la conservazione e la degustazione di champagne e vino. Sul Catalogo Illuminazione 2025 Ed. 02 e sul sito [www.nanoledlighting.com](http://www.nanoledlighting.com) troverete accanto a ciascun prodotto il nostro simbolo LED AMBRA VINO

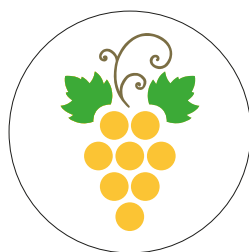

LED AMBRA VINO  
Conforme agli standard del  
Comité Interprofessionnel du vin de Champagne  
(CIVIC)



# INDICE PER FAMIGLIA DI PRODOTTO

## MICROSPOT

HALLEY	12
--------	----

## INCASSI DA INTERNO

MINI VESTA	16
EOS	17
EOS Q	18
EOS PLAFONE	19
EOS METAL	20
EOS METAL Q	21
BASIK 1	22
BASIK Q	23
BIONIK 1	24
BIONIK Q	25
FOUR HOLE	26
FOUR HOLE Q	27

## INCASSI DA INTERNO ED ESTERNO

HOLLY	30
HALISSA	31
MEMO	32
DEHO 2	33
DEHO 3	34
DEHO 4	35
DEHO 5	36
DEHO Q	37
DARDO 2	38
DARDO 3	39
DARDO Q	40
ACSO 1	41
ACSO 2	42
ACSO 3	43

## PROIETTORI

DUVAR	46
VERTIGO	47
ZEPPELIN	48

## ILLUMINAZIONE TECNICO DECORATIVO

PIXEL 1	52
EVA	53
REM	54
CISO PLAFONE P31	55
CISO PLAFONE P33	56
CISO SOSPENSIONE S31	57
CISO SOSPENSIONE S33	58
ROSONI PER ALTRE COMPOSIZIONI CISO	59

## ACCESSORI DI INSTALLAZIONE



















CASSAFORMA HOLLY, HALISSA E MEMO	62
CASSAFORMA SERIE ACSO	62
ANELLO SERIE ACSO	62
CASSAFORMA SERIE DEHO E DARDO	63
ANELLO SERIE DEHO E DARDO	63
BASE E PICCHETTO DUVAR	63

# INDICE ALFABETICO

<b>A</b>		<b>E</b>	
ACSO 1	41	EOS	17
ACSO 2	42	EOS METAL	20
ACSO 3	43	EOS METAL Q	21
ANELLO SERIE ACSO	62	EOS PLAFONE	19
ANELLO SERIE DEHO E DARDO	63	EOS Q	18
<b>B</b>		EVA	53
BASE E PICCHETTO DUVAR	63	<b>F</b>	
BASIK 1	22	FOUR HOLE	26
BASIK Q	23	FOUR HOLE Q	27
BIONIK 1	24	<b>H</b>	
BIONIK Q	25	HALISSA	31
<b>C</b>		HALLEY	12
CASSAFORMA HOLLY, HALISSA E MEMO	62	HOLLY	30
CASSAFORMA SERIE ACSO	62	<b>M</b>	
CASSAFORMA SERIE DEHO E DARDO	63	MEMO	32
CISO PLAFONE P31	55	MINI VESTA	16
CISO PLAFONE P33	56	<b>P</b>	
CISO SOSPENSIONE S31	57	PIXEL 1	52
CISO SOSPENSIONE S33	58	<b>R</b>	
<b>D</b>		REM	54
DARDO 2	38	ROSONI PER ALTRE COMPOSIZIONI CISO	59
DARDO 3	39	<b>V</b>	
DARDO Q	40	VERTIGO	47
DEHO 2	33	<b>Z</b>	
DEHO 3	34	ZEPPELIN	48
DEHO 4	35		
DEHO 5	36		
DEHO Q	37		
DUVAR	46		



# SIMBOLI

-  Prodotto conforme alle normative europee in materia di sicurezza elettrica.
-  Prodotto sottoposto alle normative europee RAEE in materia di smaltimento.
-  Prodotto realizzato con materiale riciclabile.
-  Classe III. Prodotti alimentati con tensione di sicurezza inferiore a 50V.
-  **IP..** Indice di protezione (vedi sotto).
-  Prodotto che può essere installato sia in ambienti interni che esterni.
-  Prodotto che può essere installato in ambienti interni.
-  Indica il peso teorico del prodotto, privo di cablaggi.
-  Prodotto idoneo ad essere montato su superfici normalmente infiammabili.
-  Indica che il colore Ambra "vino" previene il "gusto di luce". È indicato ed approvato dal Comité Interprofessionnel du vin de Champagne (CIVIC) per l'illuminazione di cantine, sale di conservazione e arredi.
-  Prodotto idoneo ad essere inserito nei mobili.
-  Indica che il prodotto è calpestabile.
-  Indica il tipo di ottica (simmetrica o asimmetrica) e i gradi di apertura.
-  Dimensione del foro da praticare per il montaggio senza cassaforma.
-  Indica che il prodotto è dimmerabile.
-  Classe I. Apparecchio con dispositivo per la messa a terra.
-  Classe II. Apparecchio con isolamento rinforzato o doppio isolamento, privo di dispositivo per la messa a terra.
-  Accensione tramite il tocco della superficie metallica.
-  Conformità alla Direttiva RoHs 2002/95/CE la quale vieta l'uso di sostanze pericolose nelle apparecchiature elettriche ed elettroniche (piombo, mercurio, etc..)

## INDICE DI PROTEZIONE **IP..**

La "resistenza" offerta dall'apparecchio alla penetrazione di corpi solidi e liquidi, viene indicata con il prefisso IP (international protection) seguito da due cifre significative. La prima cifra identifica il grado di protezione contro l'ingresso di corpi solidi. La seconda cifra identifica il grado di protezione contro l'ingresso di corpi liquidi.

- IP0.** Non protetto.
- IP1.** Protetto dalla penetrazione di corpi solidi di dimensioni superiori a 50mm.
- IP2.** Protetto dalla penetrazione di corpi solidi di dimensioni superiori a 12mm.
- IP3.** Protetto dalla penetrazione di corpi solidi di dimensioni superiori a 2,5mm.
- IP4.** Protetto dalla penetrazione di corpi solidi di dimensioni superiori a 1mm.
- IP5.** Protetto dalla penetrazione della polvere.
- IP6.** Protetto completamente dalla penetrazione della polvere.
- IP0.** Non protetto.
- IP1.** Protetto dalle cadute verticali di gocce d'acqua.
- IP2.** Protetto dalle cadute dell'acqua con inclinazione massima di 15°.
- IP3.** Protetto dalla pioggia.
- IP4.** Protetto dagli spruzzi.
- IP5.** Protetto dai getti d'acqua.
- IP6.** Protetto dalle ondate.
- IP7.** Protetto dall'immersione temporanea.





# MICROSPOT

HALLEY ..... 12



# HALLEY

## L31.



Incasso in alluminio tornito per illuminazione d'accento, decorazione e cortesia. Indicato anche per "cielo stellato". Ottica secondaria a scelta, installabile in ambienti interni ed esterni parzialmente protetti, montaggio con molla.

Power LED CRI>80

Potenza: 0,8W@350mA

Lumen: 50Lm@350mA

Alimentazione in corrente costante 350mA

Collegamento in serie, cavo cm 50



 **PRODOTTO IN ITALIA**

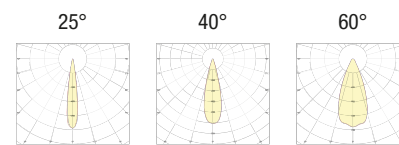
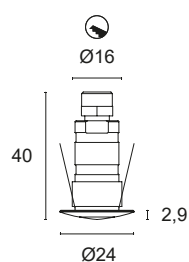

CODICI BASE

**L31.**

FINITURE

- 1 Bianco
- 2 Nero opaco
- 6 Cromo
- 7 Alluminio satinato

FASCIO LUCE

- 25 25°
- 40 40°
- 60 60°

COLORE LED

- AM Ambra "vino"
-  Approvato  
CIVIC

Esempio di codifica:

HALLEY + Bianco + Fascio luce 40° + Ambra "vino" = Codice: L31.140AM









## INCASSI DA INTERNO

MINI VESTA .....	16
EOS .....	17
EOS Q .....	18
EOS PLAFONE .....	19
EOS METAL .....	20
EOS METAL Q .....	21
BASIK 1 .....	22
BASIK Q .....	23
BIONIK 1 .....	24
BIONIK Q .....	25
FOUR HOLE .....	26
FOUR HOLE Q .....	27

# MINI VESTA

## L9X.



Incasso in termoplastico per illuminazione d'accento, decorazione e cortesia. Illuminazione diffusa, installabile in ambienti interni, montaggio a pressione.

Power LED CRI>80

Potenza: 0,8W@350mA - 1,2W@500mA

Lumen: 50Lm@350mA - 70Lm@500mA

Alimentazione in corrente costante 350mA - 500mA

Collegamento in serie, cavo cm 50



 **PRODOTTO IN ITALIA**

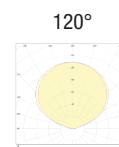
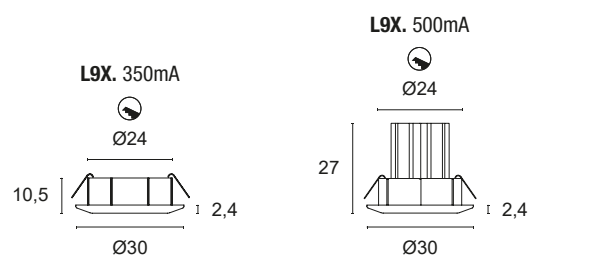

CODICI BASE

**L9X.**

FINITURE

- 1 Bianco
- 6 Cromo
- 7 Alluminio satinato
- 8 Trasparente

FASCIO LUCE

00 120°

COLORE LED

- AM Ambra "vino"
-  Approvato CIVIC

POTENZA

- 3** 1x0.8W - 350mA - 50 lm
- 5** 1x1,2W - 500mA - 70 lm

Esempio di codifica:

MINI VESTA + Bianco + Fascio di luce 120° + Ambra "vino" + 0,8W = Codice: L9X.100AM3



# EOS

## L95.



Incasso in termoplastico per illuminazione d'accento, decorazione e cortesia. Ottica secondaria a scelta, installabile in ambienti interni, montaggio a pressione.

Power LED CRI>80

Potenza: 0,8W@350mA - 1,2W@500mA

Lumen: 50Lm@350mA - 70Lm@500mA

Alimentazione in corrente costante 350mA - 500mA

Collegamento in serie, cavo cm 50



 **PRODOTTO IN ITALIA**



**L95. 500mA**

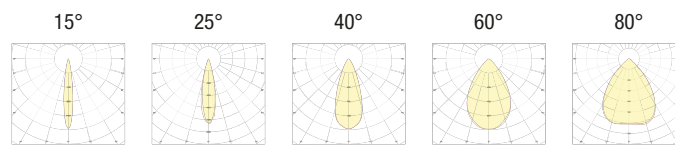
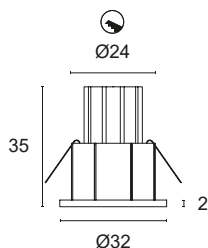
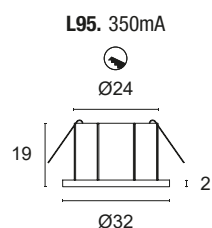

**CODICI BASE**

**L95.**

**FINITURE**

- 1 Bianco
- 2 Nero opaco
- 3 Oro satinato
- 6 Cromo
- 7 Alluminio satinato
- 8 Trasparente
- 9 Oro lucido

**FASCIO LUCE**

- 15 15°
- 25 25°
- 40 40°
- 60 60°
- 80 80°

**COLORE LED**

- AM** Ambra "vino"
-  Approvato CIVIC

**POTENZA**

- 3** 1x0,8W - 350mA - 50 lm
- 5** 1x1,2W - 500mA - 70 lm

**Esempio di codifica:**

EOS + Alluminio satinato + Fascio di luce 15° + Ambra "vino" + 0,8W = Codice: L95.715AM3



# EOS Q

## L9Q.



Incasso in termoplastico per illuminazione d'accento, decorazione e cortesia. Ottica secondaria a scelta, installabile in ambienti interni, montaggio a pressione.

Power LED CRI>80

Potenza: 0,8W@350mA - 1,2W@500mA

Lumen: 50Lm@350mA - 70Lm@500mA

Alimentazione in corrente costante 350mA - 500mA

Collegamento in serie, cavo cm 50



 **PRODOTTO IN ITALIA**

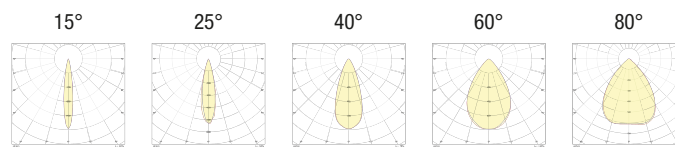
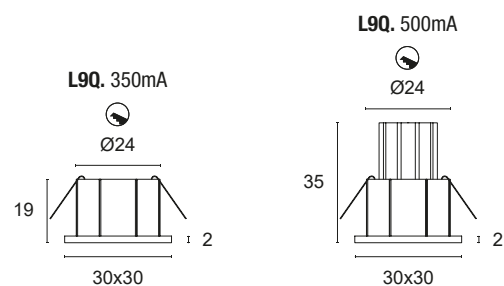

**CODICI BASE**

**L9Q.**

**FINITURE**

- 1 Bianco
- 2 Nero opaco
- 3 Oro satinato
- 6 Cromo
- 7 Alluminio satinato
- 8 Trasparente
- 9 Oro lucido

**FASCIO LUCE**

- 15 15°
- 25 25°
- 40 40°
- 60 60°
- 80 80°

**COLORE LED**

- AM Ambra "vino"
-  Approvato CIVIC

**POTENZA**

- 3** 1x0,8W - 350mA - 50 lm
- 5** 1x1,2W - 500mA - 70 lm

**Esempio di codifica:**

EOS Q + Alluminio satinato + Fascio di luce 15° + Ambra "vino" + 0,8W = Codice: L9Q.715AM3

# EOS PLAFONE

L95D.

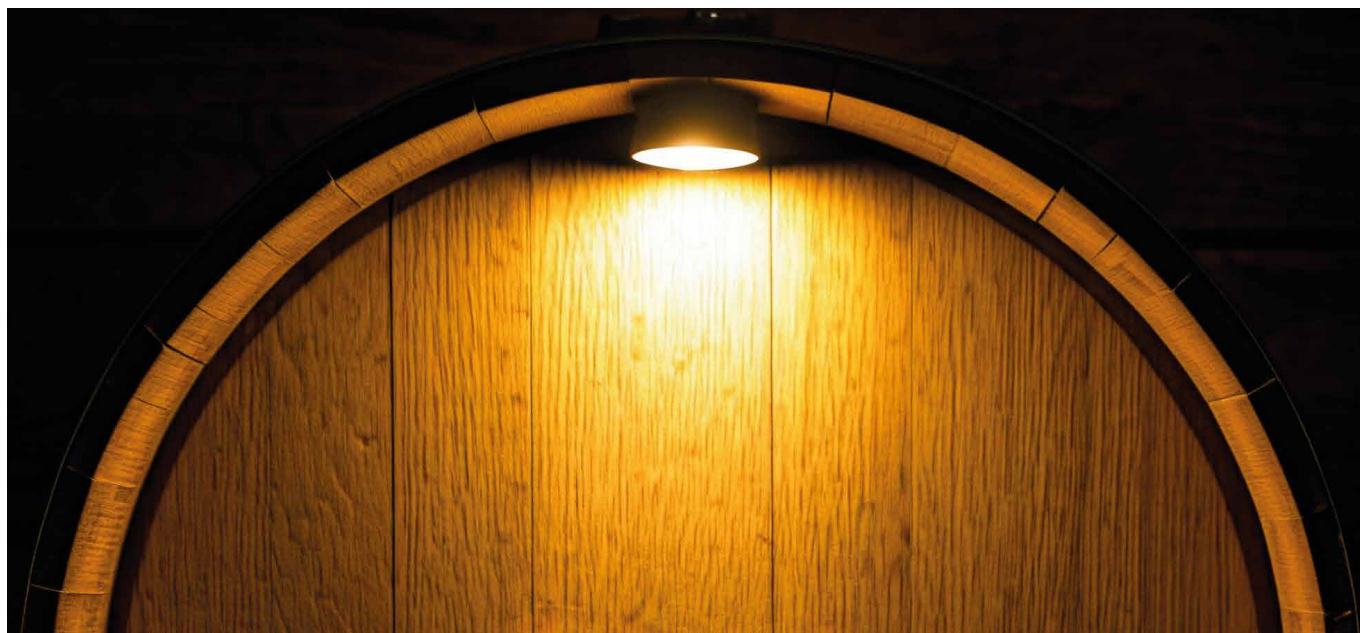

Plafone in termoplastico per illuminazione d'accento, decorazione e cortesia. Ottica secondaria a scelta, installabile in ambienti interni, montaggio con viti a scomparsa.

Power LED CRI>80

Potenza: 0,8W@350mA

Lumen: 50Lm@350mA

Alimentazione in corrente costante 350mA

Collegamento in serie, cavo cm 50

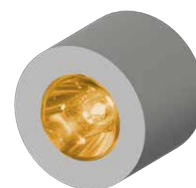

 **PRODOTTO IN ITALIA**

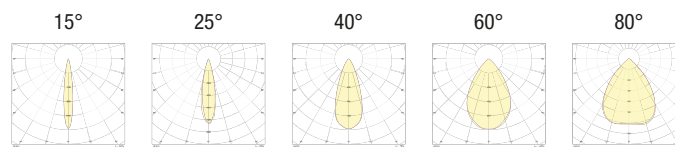
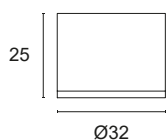

## CODICI BASE

**L95D.**

## FINITURE

- 1 Bianco
- 2 Nero opaco
- 3 Oro satinato
- 6 Cromo
- 7 Alluminio satinato
- 8 Trasparente
- 9 Oro lucido

## FASCIO LUCE

- 15 15°
- 25 25°
- 40 40°
- 60 60°
- 80 80°

## COLORE LED

- AM** Ambra "vino"
-  Approvato CIVIC

Esempio di codifica:

EOS PLAFONE + Alluminio satinato + Fascio di luce 25° + Ambra "vino" = Codice: L95D.725AM

# EOS METAL

## L95M.

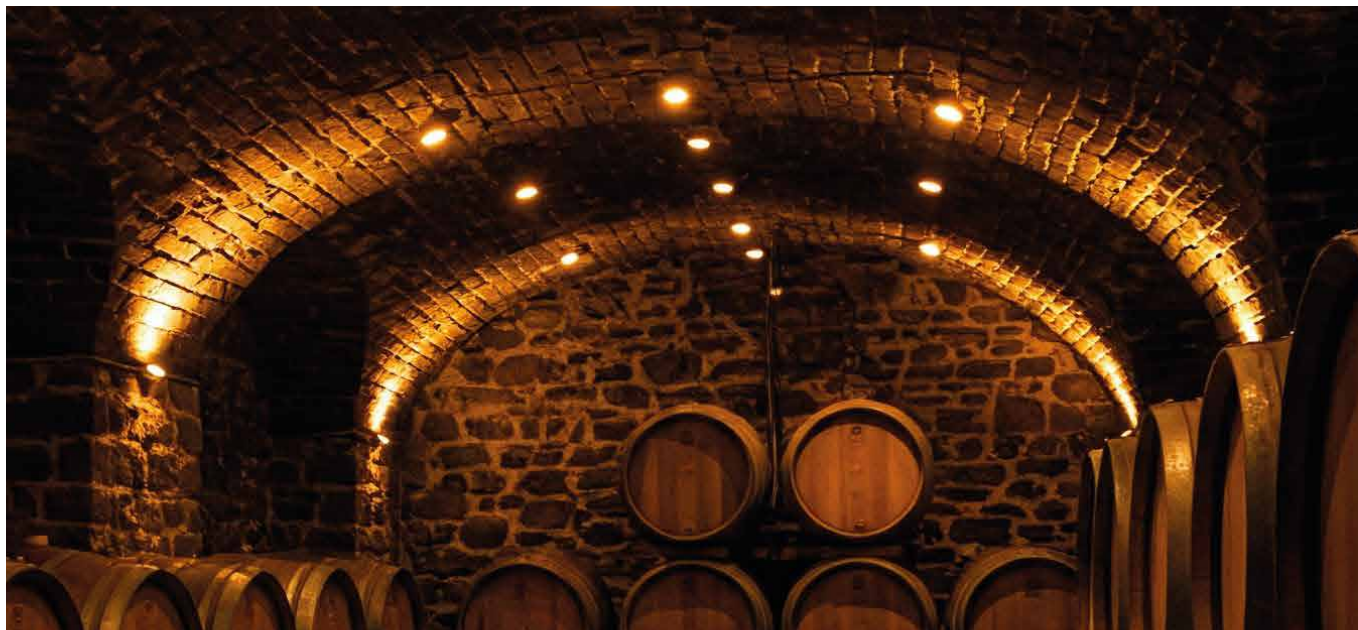

Incasso in alluminio tornito e decorato con LED di potenza per illuminazione d'accento, decorazione e cortesia. Ottica secondaria a scelta, installabile in ambienti interni. Montaggio ad incasso con molle.

Power LED CRI>80

Potenza: 1,2W@500mA

Lumen: 70Lm@500mA

Alimentazione in corrente costante 500mA

Collegamento in serie, cavo cm 50

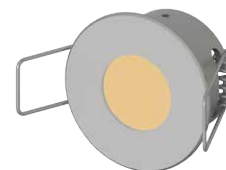

 **PRODOTTO IN ITALIA**

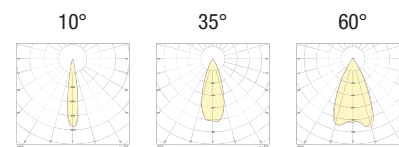
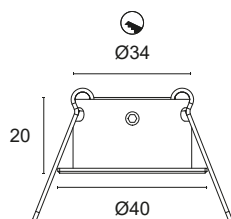

CODICI BASE

**L95M.**

FINITURE

- 1 Bianco
- 2 Nero opaco
- 5 Alluminio brillante
- 7 Alluminio satinato

FASCIO LUCE

- 10 10°
- 35 35°
- 60 60°

COLORE LED

- AM Ambra "vino"
-  Approvato  
CIVIC

Esempio di codifica:

EOS METAL + Alluminio satinato + Fascio luce 40° + Ambra "vino" = Codice: L95M.740AM



# EOS METAL Q

## L9QM.



Incasso in alluminio tornito e decorato con LED di potenza per illuminazione d'accento, decorazione e cortesia. Ottica secondaria a scelta, installabile in ambienti interni. Montaggio ad incasso con molle.

Power LED CRI>80

Potenza: 1,2W@500mA

Lumen: 70Lm@500mA

Alimentazione in corrente costante 500mA

Collegamento in serie, cavo cm 50

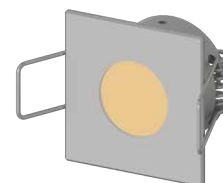

 **PRODOTTO IN ITALIA**

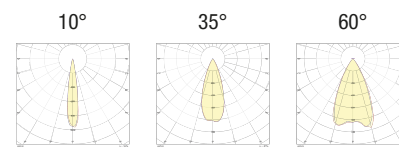
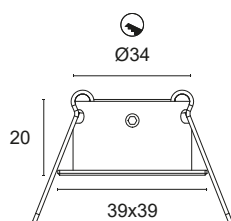

**CODICI BASE**

**L95QM.**

**FINITURE**

- 1 Bianco
- 2 Nero opaco
- 5 Alluminio brillante
- 7 Alluminio satinato

**FASCIO LUCE**

- 10 10°
- 35 35°
- 60 60°

**COLORE LED**

- AM Ambra "vino"
-  Approvato  
CIVIC

**Esempio di codifica:**

EOS METAL Q + Alluminio satinato + Fascio luce 40°+ Ambra "vino" = Codice: L9QM.740AM

# BASIK 1

L01.

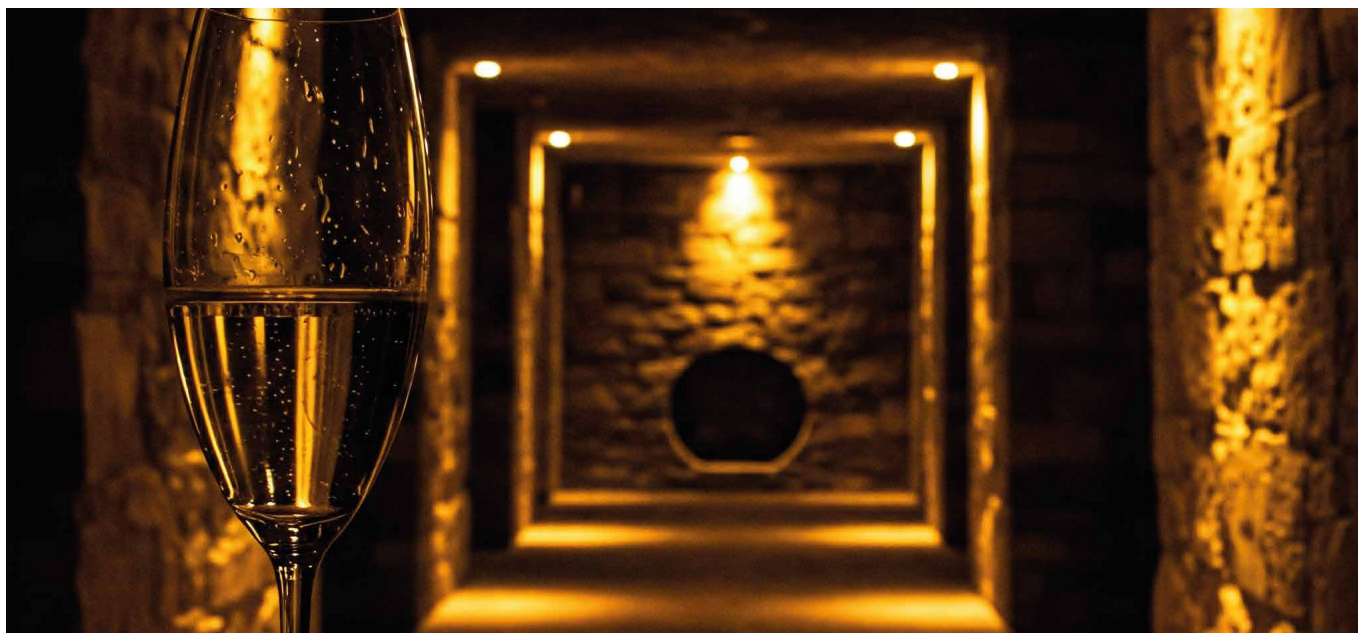

Incasso in alluminio tornito e decorato con LED di potenza adatto per illuminazione primaria di ambienti residenziali e retail. Ottica secondaria a scelta. Installabile ad incasso in ambienti interni ed esterni parzialmente protetti. Montaggio ad incasso con molle.

Power LED CRI>80

Potenza: 2,4W@350mA - 3,6W@500mA

Lumen: 150Lm@350mA - 210Lm@500mA

Alimentazione in corrente costante 350mA - 500mA

Collegamento in serie, cavo cm 50

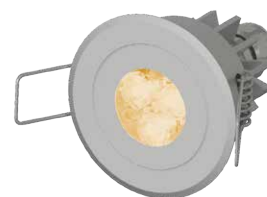

 **PRODOTTO IN ITALIA**

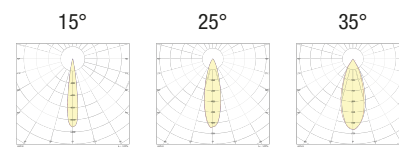
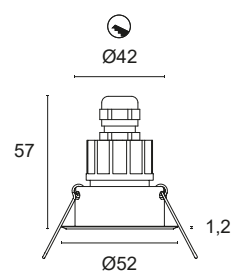

**CODICI BASE**

**L01.**

**FINITURE**

- 1 Bianco
- 2 Nero opaco
- 5 Alluminio brillante
- 6 Cromo
- 7 Alluminio satinato

**FASCIO LUCE**

- 15 15°
- 25 25°
- 35 35°

**COLORE LED**

- AM Ambra "vino"
-  Approvato CIVIC

**POTENZA**

- 3** 3x0,8W - 350mA - 150 lm
- 5** 3x1,2W - 500mA - 210 lm

**Esempio di codifica:**

BASIK 1 + Alluminio satinato + Fascio di luce 15° + Ambra "vino" + 2,4W = Codice: L01.715AM3



# BASIK Q

## L02.

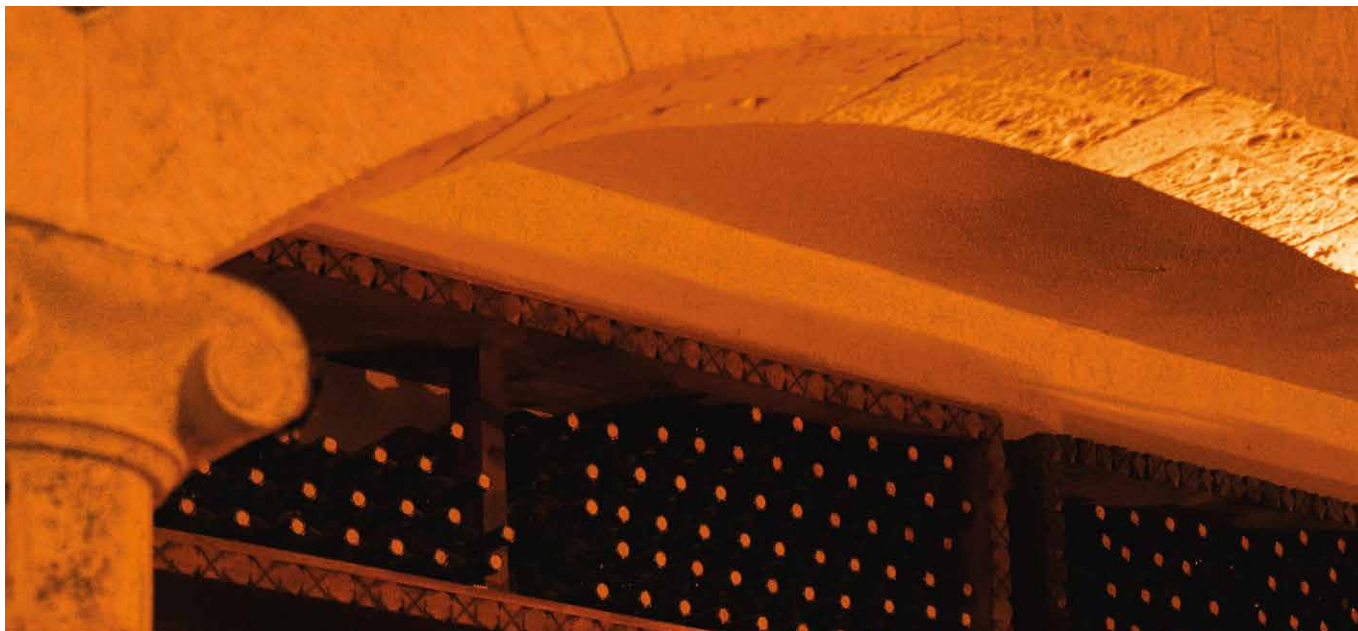

Incasso quadrato in alluminio tornito e decorato con LED di potenza adatto per illuminazione primaria di ambienti residenziali e retail. Ottica secondaria a scelta. Installabile ad incasso in ambienti interni ed esterni parzialmente protetti. Montaggio ad incasso con molle.

Power LED CRI>80

Potenza: 2,4W@350mA - 3,6W@500mA

Lumen: 150Lm@350mA - 210Lm@500mA

Alimentazione in corrente costante 350mA - 500mA

Collegamento in serie, cavo cm 50

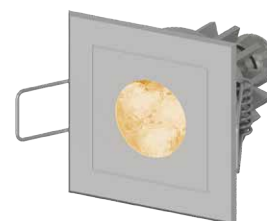

 **PRODOTTO IN ITALIA**

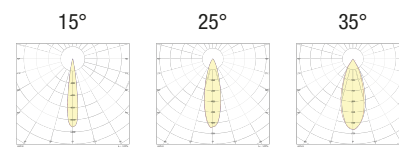
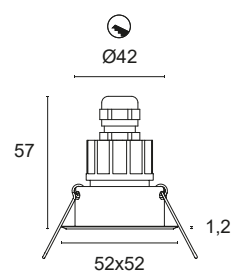

**CODICI BASE**

**L02.**

**FINITURE**

- 1 Bianco
- 2 Nero opaco
- 5 Alluminio brillante
- 6 Cromo
- 7 Alluminio satinato

**FASCIO LUCE**

- 15 15°
- 25 25°
- 35 35°

**COLORE LED**

- AM Ambra "vino"
-  Approvato CIVIC

**POTENZA**

- 3** 3x0,8W - 350mA - 150 lm
- 5** 3x1,2W - 500mA - 210 lm

**Esempio di codifica:**

BASIK Q + Alluminio satinato + Fascio di luce 15° + Ambra "vino" + 2,4W = Codice: L02.715AM3

# BIONIK 1

## L21.

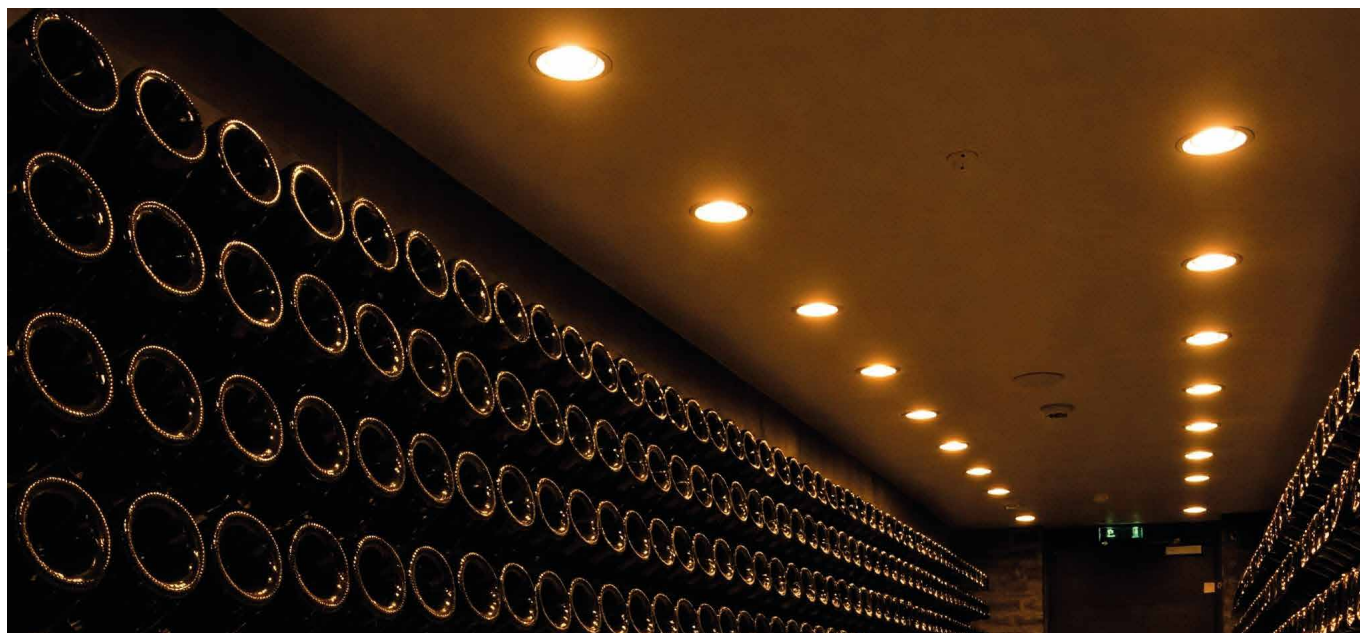

Incasso in alluminio tornito e decorato con LED di potenza adatto per illuminazione primaria di ambienti residenziali e retail. Ottica secondaria recessa a scelta. Installabile ad incasso in ambienti interni ed esterni parzialmente protetti. Montaggio ad incasso con molle.

Power LED CRI>80

Potenza: 2,4W@350mA - 3,6W@500mA

Lumen: 150Lm@350mA - 210Lm@500mA

Alimentazione in corrente costante 350mA - 500mA

Collegamento in serie, cavo cm 50



 **PRODOTTO IN ITALIA**

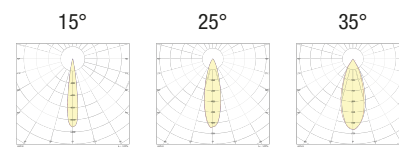
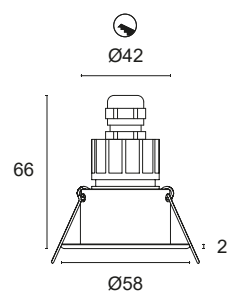

**CODICI BASE**

**L21.**

**FINITURE**

- 1 Bianco
- 2 Nero opaco
- 5 Alluminio brillante
- 6 Cromo
- 7 Alluminio satinato

**FASCIO LUCE**

- 15 15°
- 25 25°
- 35 35°

**COLORE LED**

- AM Ambra "vino"
-  Approvato CIVIC

**POTENZA**

- 3** 3x0,8W - 350mA - 150 lm
- 5** 3x1,2W - 500mA - 210 lm

**Esempio di codifica:**

BIONIK 1 + Alluminio satinato + Fascio di luce 15° + Ambra "vino" + 2,4W = Codice: L21.715AM3

# BIONIK Q

## L22.

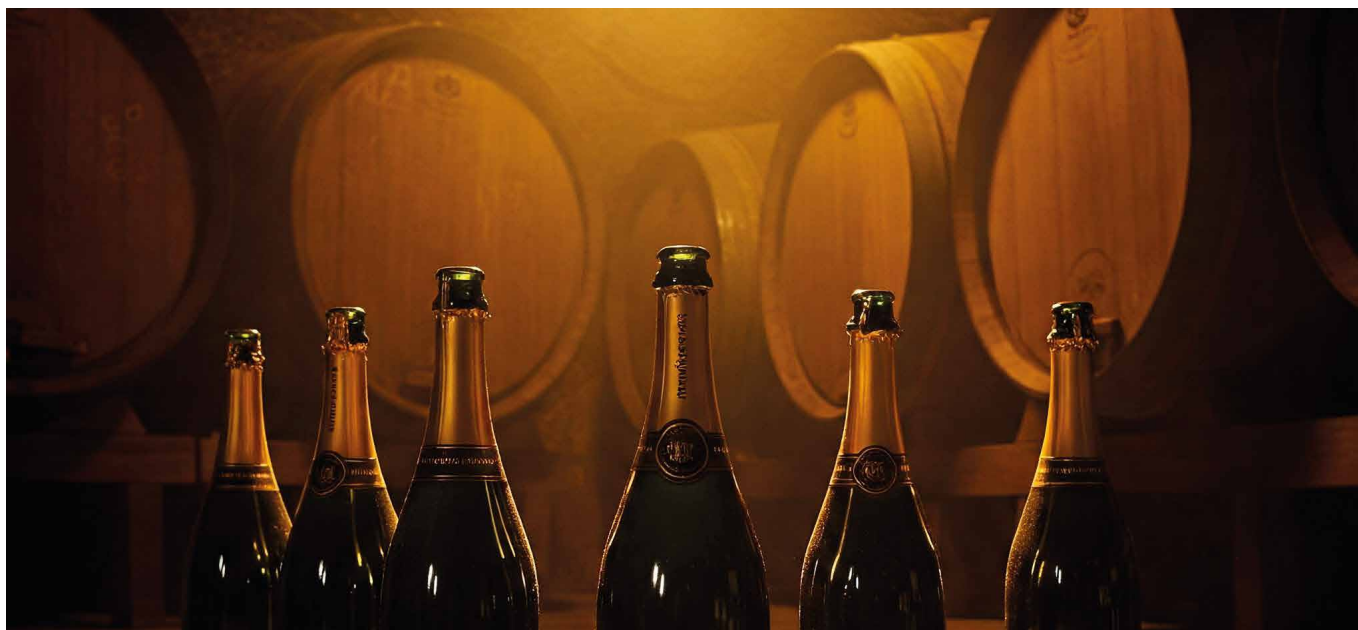

Incasso quadrato in alluminio tornito e decorato con LED di potenza adatto per illuminazione primaria di ambienti residenziali e retail. Ottica secondaria recessa a scelta. Installabile ad incasso in ambienti interni ed esterni parzialmente protetti. Montaggio ad incasso con molle.

Power LED CRI>80

Potenza: 2,4W@350mA - 3,6W@500mA

Lumen: 150Lm@350mA - 210Lm@500mA

Alimentazione in corrente costante 350mA - 500mA

Collegamento in serie, cavo cm 50

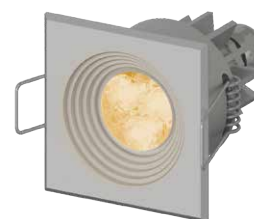

 **PRODOTTO IN ITALIA**

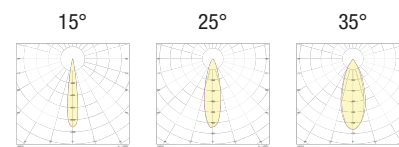
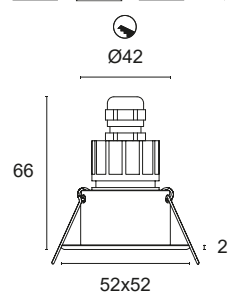

CODICI BASE

**L22.**

FINITURE

- 1 Bianco
- 2 Nero opaco
- 5 Alluminio brillante
- 6 Cromo
- 7 Alluminio satinato

FASCIO LUCE

- 15 15°
- 25 25°
- 35 35°

COLORE LED

- AM Ambra "vino"
-  Approvato CIVIC

POTENZA

- 3** 3x0,8W - 350mA - 150 lm
- 5** 3x1,2W - 500mA - 210 lm

Esempio di codifica:

BIONIK Q + Alluminio satinato + Fascio di luce 15° + Ambra "vino" + 2,4W = Codice: L22.715AM3

# FOUR HOLE

## L24.

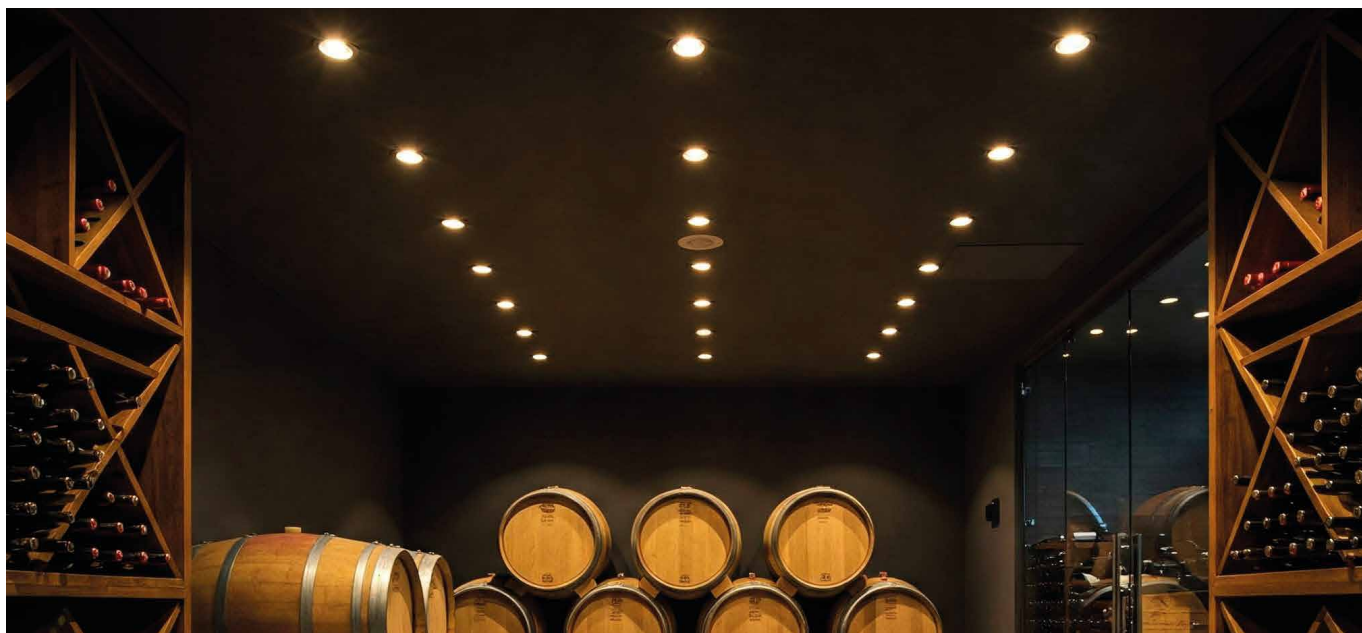

Incasso in alluminio tornito e decorato con LED di potenza adatto per illuminazione primaria di ambienti residenziali e retail. Ottica secondaria recessa a scelta. Installabile ad incasso in ambienti interni. Montaggio ad incasso con molle.

Power LED CRI>80

Potenza: 3,2W@350mA - 4,8W@500mA

Lumen: 200Lm@350mA - 280Lm@500mA

Alimentazione in corrente costante 350mA - 500mA

Collegamento in serie, cavo cm 50

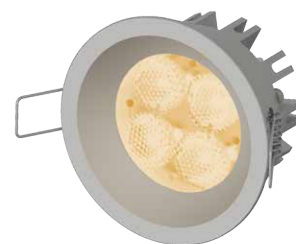

 **PRODOTTO IN ITALIA**

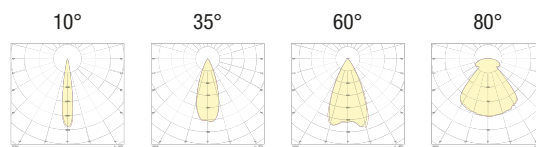
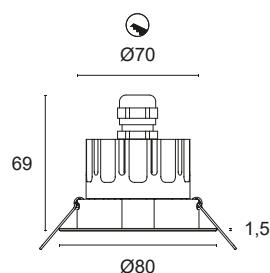

**CODICI BASE**

**L24.**

**FINITURE**

- 1 Bianco
- 2 Nero opaco
- 5 Alluminio brillante
- 7 Alluminio satinato

**FASCIO LUCE**

- 10 10°
- 35 35°
- 60 60°
- 80 80°

**COLORE LED**

- AM Ambra "vino"
-  Approvato CIVIC

**POTENZA**

- 3 4x0,8W - 350mA - 200 lm
- 5 4x1,2W - 500mA - 280 lm

**Esempio di codifica:**

FOUR HOLE + Bianco + Fascio di luce 80° + Ambra "vino" + 3,2W = Codice: L24.180AM3



# FOUR HOLE Q

## L25.



Incasso quadrato in alluminio tornito e decorato con LED di potenza adatto per illuminazione primaria di ambienti residenziali e retail. Ottica secondaria recessa a scelta. Installabile ad incasso in ambienti interni. Montaggio ad incasso con molle.

Power LED CRI>80

Potenza: 3,2W@350mA - 4,8W@500mA

Lumen: 200Lm@350mA - 280Lm@500mA

Alimentazione in corrente costante 350mA - 500mA

Collegamento in serie, cavo cm 50

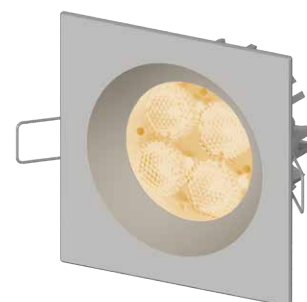

 **PRODOTTO IN ITALIA**

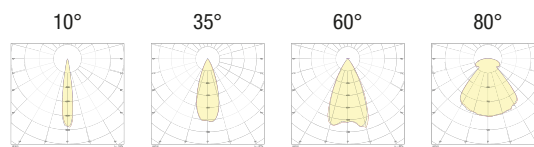
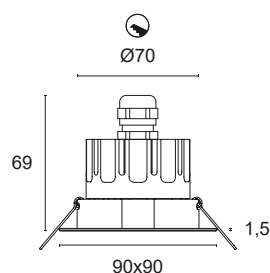

**CODICI BASE**

**L25.**

**FINITURE**

- 1 Bianco
- 2 Nero opaco
- 5 Alluminio brillante
- 7 Alluminio satinato

**FASCIO LUCE**

- 10 10°
- 35 35°
- 60 60°
- 80 80°

**COLORE LED**

- AM Ambra "vino"
-  Approvato CIVIC

**POTENZA**

- 3 4x0,8W - 350mA - 200 lm
- 5 4x1,2W - 500mA - 280 lm

**Esempio di codifica:**

FOUR HOLE Q + Bianco + Fascio di luce 80° + Ambra "vino" + 3,2W = Codice: L25.180AM3





## INCASSI DA INTERNO ED ESTERNO

HOLLY	30
HALISSA	31
MEMO	32
DEHO 2	33
DEHO 3	34
DEHO 4	35
DEHO 5	36
DEHO Q	37
DARDO 2	38
DARDO 3	39
DARDO Q	40
ACSO 1	41
ACSO 2	42
ACSO 3	43

# HOLLY

## L30R.

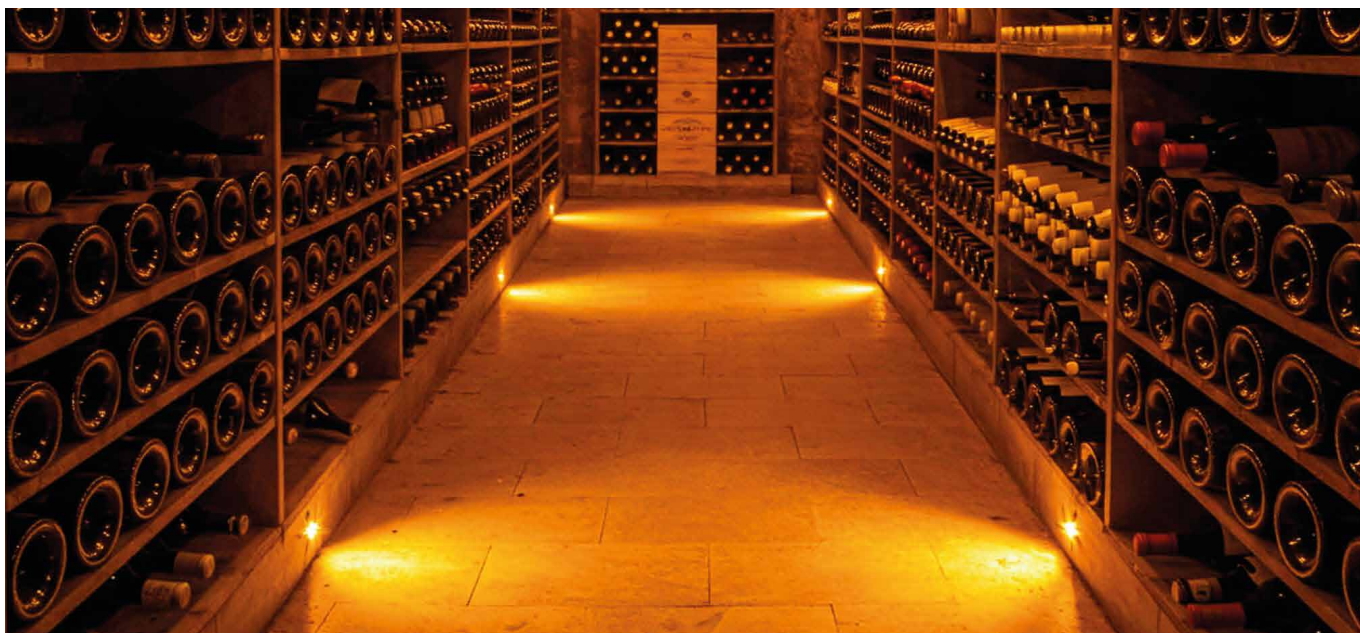

Incasso in acciaio 304 tornito con LED di potenza per illuminazione d'accento, decorazione, cortesia o segna passo. Ottica secondaria a scelta. Installabile a pavimento, a parete o su cartongesso in ambienti interni ed esterni. Montaggio con cassaforma.

Power LED CRI>80

Potenza: 0,8W@350mA

Lumen: 50Lm@350mA

Alimentazione in corrente costante 350mA

Collegamento in serie, cavo cm 50



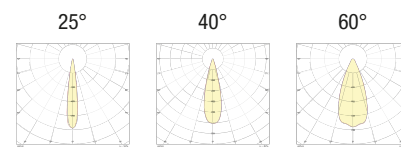
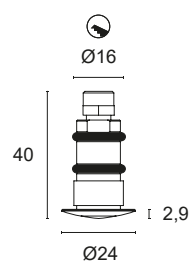

 **PRODOTTO IN ITALIA**



CODICI BASE

**L30R.**

FASCIO LUCE

-  **25** 25°
-  **40** 40°
-  **60** 60°

VETRO

-  **T** Trasparente
-  **S** Sabbiato

COLORE LED

-  **AM** Ambra "vino"
-  Approvato CIVIC

Esempio di codifica:

HOLLY + Fascio luce 25° + Vetro trasparente + Ambra "vino" = Codice: L30R.25TAM



# HALISSA

## L30Q.

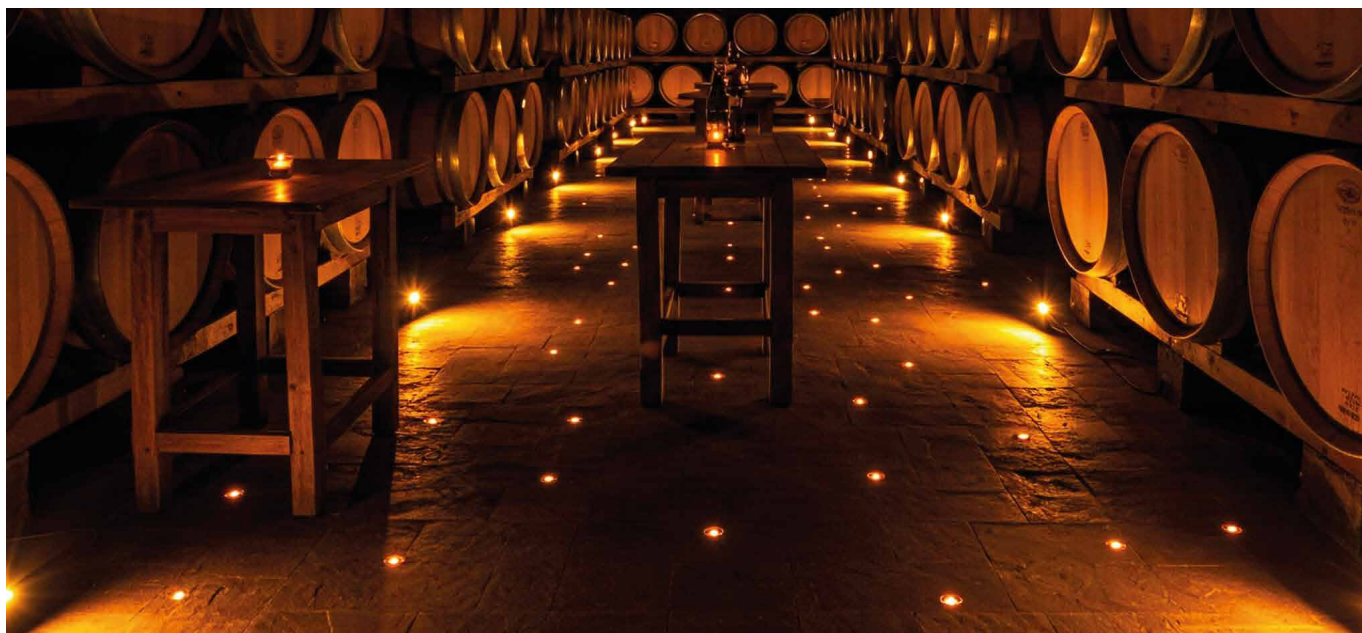

Incasso in acciaio 304 tornito con LED di potenza per illuminazione d'accento, decorazione, cortesia o segna passo. Ottica secondaria a scelta. Installabile a pavimento, a parete o su cartongesso in ambienti interni ed esterni. Montaggio con cassaforma.

Power LED CRI>80

Potenza: 0,8W@350mA

Lumen: 50Lm@350mA

Alimentazione in corrente costante 350mA

Collegamento in serie, cavo cm 50



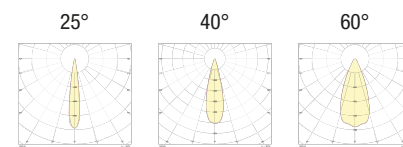
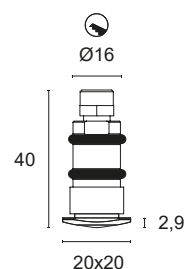

 **PRODOTTO IN ITALIA**



CODICI BASE

**L30Q.**

FASCIO LUCE

-  **25** 25°
-  **40** 40°
-  **60** 60°

VETRO

-  **T** Trasparente
-  **S** Sabbiato

COLORE LED

-  **AM** Ambra "vino"
-  Approvato CIVIC

Esempio di codifica:

HALISSA + Fascio luce 25°+ Vetro trasparente + Ambra "vino" = Codice: L30Q.25TAM

# MEMO L30S.

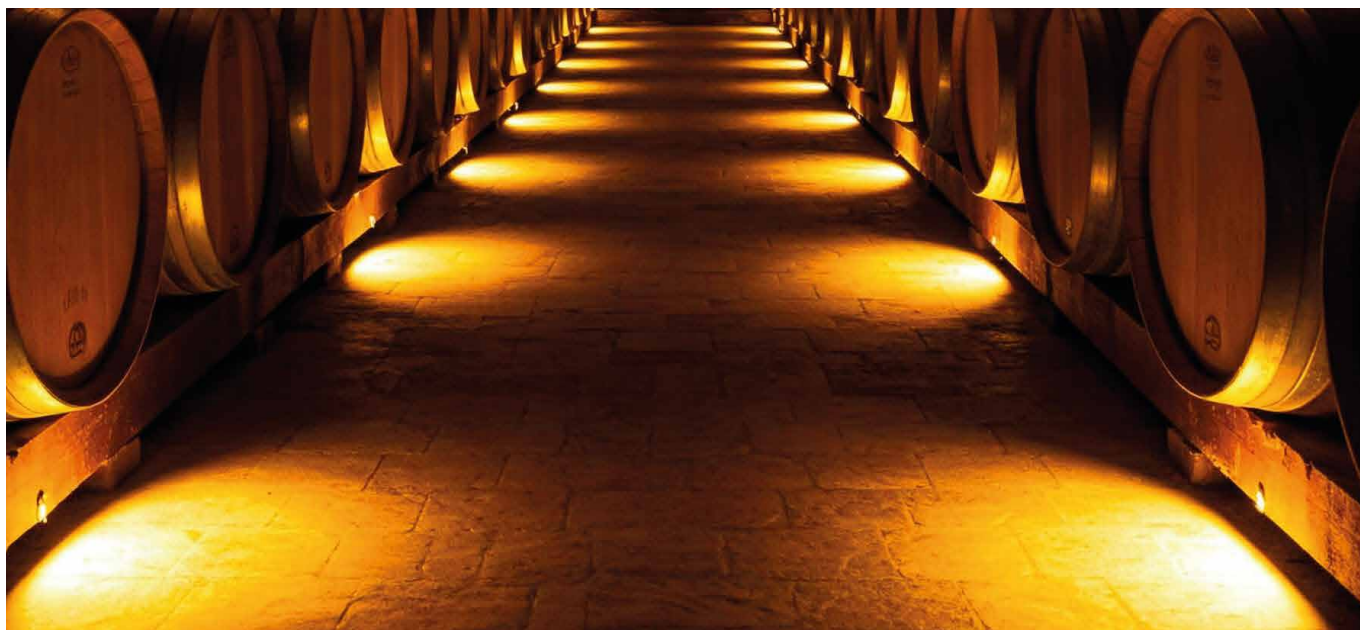

Incasso in acciaio 304 tornito con LED di potenza per illuminazione di decorazione, cortesia o segna passo. Illuminazione diffusa con palpebra anti abbagliamento. Installabile a parete o pavimento in ambienti interni ed esterni. Montaggio con cassaforma.

Power LED CRI>80

Potenza: 0,8W@350mA

Lumen: 50Lm@350mA

Alimentazione in corrente costante 350mA

Collegamento in serie, cavo cm 50



 **PRODOTTO IN ITALIA**

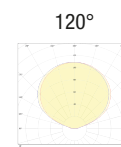
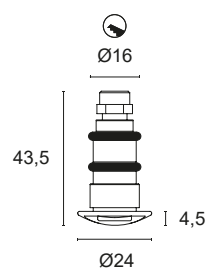

**CODICI BASE**

**L30S.**

**FASCIO LUCE**

 **R1** Radiale 1 apertura  **T** Trasparente

**VETRO**

**COLORE LED**

 **AM** Ambra "vino"



**Esempio di codifica:**

MEMO + Fascio luce radiale 1 apertura + Vetro trasparente + Ambra "vino" = Codice: L30S.R1TAM



# DEHO 2

## L402.



Incasso in acciaio 304 tornito con LED di potenza per illuminazione d'accento, decorazione, cortesia o segna passo. Ottica secondaria a scelta. Installabile a pavimento, a parete o su cartongesso in ambienti interni ed esterni. Montaggio con cassaforma o anello con molle.

Power LED CRI>80

Potenza: 0,8W@350mA - 1,2W@500mA

Lumen: 50Lm@350mA - 70Lm@500mA

Alimentazione in corrente costante 350mA - 500mA

Collegamento in serie, cavo cm 50





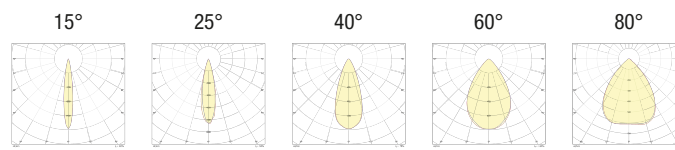
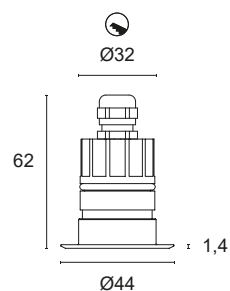

 **PRODOTTO IN ITALIA**



**CODICI BASE**

**L402.**

**FASCIO LUCE**

-  **15** 15°
-  **25** 25°
-  **40** 40°
-  **60** 60°
-  **80** 80°

**VETRO**

-  **T** Trasparente
-  **S** Sabbiato

**COLORE LED**

-  **AM** Ambra "vino"
-  Approvato CIVIC

**POTENZA**

- 3** 1x0,8W - 350mA - 50 lm
- 5** 1x1,2W - 500mA - 70 lm

**Esempio di codifica:**

DEHO 2 + Fascio di luce 25° + Vetro trasparente + Ambra "vino" + 0,8W = Codice: L402.25TAM3

# DEHO 3

## L403.

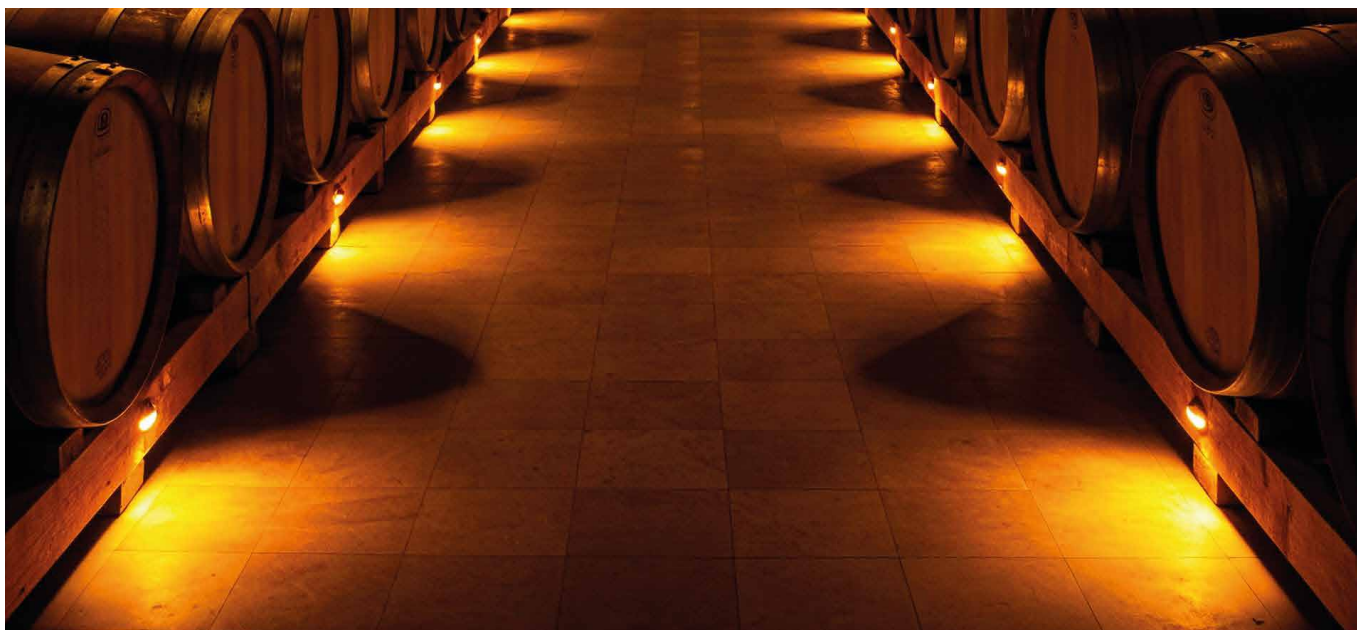

Incasso tornito in acciaio 304 per illuminazione d'accento, decorazione, cortesia e segna passo. Diffusione radiale anti abbagliamento, installabile in ambienti interni ed esterni. Montaggio con cassaforma per muratura.

Power LED CRI>80

Potenza: 0,8W@350mA - 1,2W@500mA

Lumen: 50Lm@350mA - 70Lm@500mA

Alimentazione in corrente costante 350mA - 500mA

Collegamento in serie, cavo cm 50



 **PRODOTTO IN ITALIA**

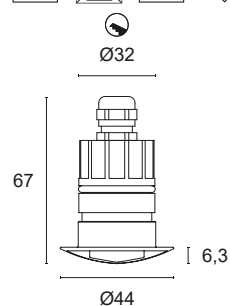

CODICI BASE

**L403.**

FASCIO LUCE

 **R1** Radiale 1 apertura

COLORE LED

 **AM** Ambra "vino"



Approvato  
CIVIC

POTENZA

**3** 1x0,8W - 350mA - 50 lm

**5** 1x1,2W - 500mA - 70 lm

Esempio di codifica:

DEHO 3 + Fascio luce radiale 1 apertura + Ambra "vino" + 0,8W = Codice: L403.R1AM3

# DEHO 4 L404.



Incasso tornito in acciaio 304 per illuminazione d'accento, decorazione, cortesia e segna passo. Diffusione radiale anti abbagliamento, installabile in ambienti interni ed esterni. Montaggio con cassaforma per muratura.

Power LED CRI>80

Potenza: 0,8W@350mA - 1,2W@500mA

Lumen: 50Lm@350mA - 70Lm@500mA

Alimentazione in corrente costante 350mA - 500mA

Collegamento in serie, cavo cm 50



 **PRODOTTO IN ITALIA**

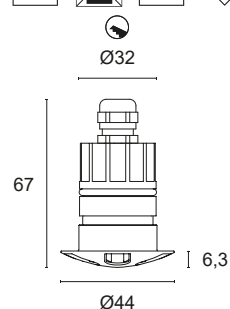

CODICI BASE

**L404.**

FASCIO LUCE

 **R5** Radiale 5 aperture

COLORE LED

 **AM** Ambra "vino"



Approvato  
CIVIC

POTENZA

**3** 1x0,8W - 350mA - 50 lm

**5** 1x1,2W - 500mA - 70 lm

Esempio di codifica:

DEHO 4 + Fascio luce radiale 5 aperture + Ambra "vino" + 0,8W = Codice: **L404.R5AM3**



# DEHO 5

## L402B



Incasso in acciaio 304 tornito per illuminazione di decorazione, cortesia e segna passo. Diffusore opalino. Installabile a pavimento o parete in ambienti interni ed esterni, montaggio con cassaforma.

Power LED CRI>80

Potenza: 0,8W@350mA - 1,2W@500mA

Lumen: 50Lm@350mA - 70Lm@500mA

Alimentazione in corrente costante 350mA - 500mA

Collegamento in serie, cavo cm 50



 **PRODOTTO IN ITALIA**

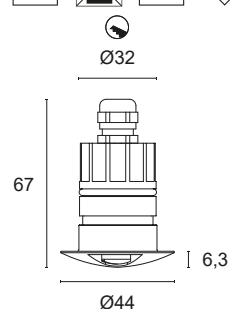

Ø44

CODICI BASE

**L402B.**

FASCIO LUCE

 **R2** Radiale 2 aperture

COLORE LED

 **AM** Ambra "vino"



Approvato  
CIVIC

POTENZA

**3** 1x0,8W - 350mA - 50 lm

**5** 1x1,2W - 500mA - 70 lm

Esempio di codifica:

DEHO 5 + Fascio di luce radiale 2 aperture + Ambra "vino" + 0,8W = Codice: L402B.R2AM3



# DEHO Q

## L405.



Incasso in acciaio 304 tornito con LED di potenza per illuminazione d'accento, decorazione, cortesia o segna passo. Ottica secondaria a scelta. Installabile a pavimento, a parete o su cartongesso in ambienti interni ed esterni. Montaggio con cassaforma o anello con molle.

Power LED CRI>80

Potenza: 0,8W@350mA - 1,2W@500mA

Lumen: 50Lm@350mA - 70Lm@500mA

Alimentazione in corrente costante 350mA - 500mA

Collegamento in serie, cavo cm 50





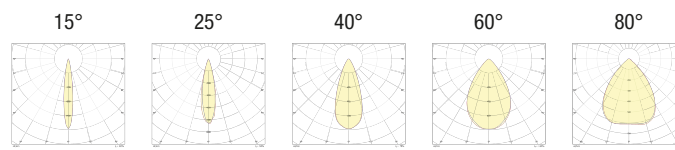
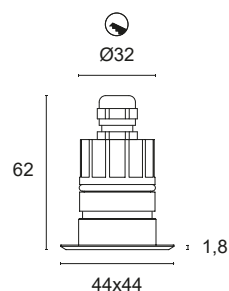

 **PRODOTTO IN ITALIA**



**CODICI BASE**

**L405.**

**FASCIO LUCE**

-  **15** 15°
-  **25** 25°
-  **40** 40°
-  **60** 60°
-  **80** 80°

**VETRO**

-  **T** Trasparente
-  **S** Sabbiato

**COLORE LED**

-  **AM** Ambra "vino"
-  Approvato CIVIC

**POTENZA**

- 3** 1x0,8W - 350mA - 50 lm
- 5** 1x1,2W - 500mA - 70 lm

**Esempio di codifica:**

DEHO Q + Fascio di luce 25° + Vetro trasparente + Ambra "vino" + 0,8W = Codice: L405.25TAM3

# DARDO 2

L502.



Incasso in acciaio 304 tornito con LED di potenza per illuminazione d'accento, decorazione, cortesia o segna passo. Ottica secondaria a scelta. Installabile a pavimento, a parete o su cartongesso in ambienti interni ed esterni. Montaggio con cassaforma o anello con molle.

Power LED CRI>80

Potenza: 2,4W@350mA - 3,6W@500mA

Lumen: 150Lm@350mA - 210Lm@500mA

Alimentazione in corrente costante 350mA - 500mA

Collegamento in serie, cavo cm 50



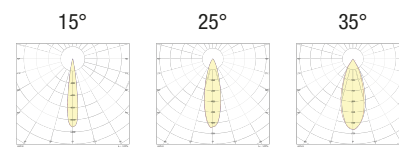
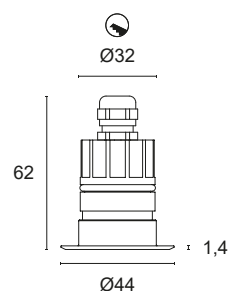

 **PRODOTTO IN ITALIA**



**CODICI BASE**

**L502.**

**FASCIO LUCE**

-  **15** 15°
-  **25** 25°
-  **35** 35°

**VETRO**

-  **T** Trasparente
-  **S** Sabbciato

**COLORE LED**

-  **AM** Ambra "vino"
-  Approvato CIVIC

**POTENZA**

- 3** 3x0,8W - 350mA - 150 lm
- 5** 3x1,2W - 500mA - 210 lm

**Esempio di codifica:**

DARDO 2 + Fascio di luce 15° + Vetro trasparente + Ambra "vino" + 2,4W = Codice: L502.15TAM3

# DARDO 3

L503.



Incasso tornito in acciaio 304 con LED di potenza per illuminazione decorativa o segna passo. Diffusione radiale anti abbagliamento, installabile in ambienti interni ed esterni. Montaggio con cassaforma per muratura.

Power LED CRI>80

Potenza: 2,4W@350mA - 3,6W@500mA

Lumen: 150Lm@350mA - 210Lm@500mA

Alimentazione in corrente costante 350mA - 500mA

Collegamento in serie, cavo cm 50



 **PRODOTTO IN ITALIA**

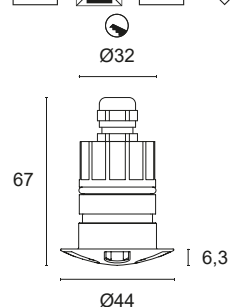

CODICI BASE

**L503.**

FASCIO LUCE

 **R5** Radiale 5 aperture

COLORE LED

 **AM** Ambra "vino"



Approvato  
CIVIC

POTENZA

**3** 3x0,8W - 350mA - 150 lm

**5** 3x1,2W - 500mA - 210 lm

Esempio di codifica:

DARDO 3 + Fascio luce radiale 5 aperture + Ambra "vino" + 2,4W = Codice: L503.R5AM3

# DARDO Q

## L504.



Incasso in acciaio 304 tornito con LED di potenza per illuminazione d'accento, decorazione, cortesia o segna passo. Ottica secondaria a scelta. Installabile a pavimento, a parete o su cartongesso in ambienti interni ed esterni. Montaggio con cassaforma o anello con molle.

Power LED CRI>80

Potenza: 2,4W@350mA - 3,6W@500mA

Lumen: 150Lm@350mA - 210Lm@500mA

Alimentazione in corrente costante 350mA - 500mA

Collegamento in serie, cavo cm 50



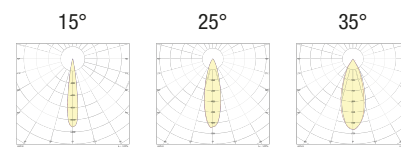
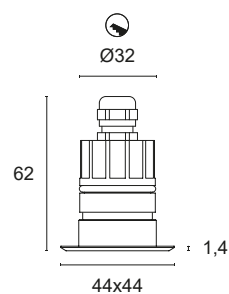

 **PRODOTTO IN ITALIA**



**CODICI BASE**

**L504.**

**FASCIO LUCE**

-  **15** 15°
-  **25** 25°
-  **35** 35°

**VETRO**

-  **T** Trasparente
-  **S** Sabbiato

**COLORE LED**

-  **AM** Ambra "vino"
-  **Approvato CIVIC**

**POTENZA**

- 3** 3x0,8W - 350mA - 150 lm
- 5** 3x1,2W - 500mA - 210 lm

**Esempio di codifica:**

DARDO Q + Fascio di luce 15° + Vetro trasparente + Ambra "vino" + 2,4W = Codice: L504.15TAM3



# ACSO 1

## L601.

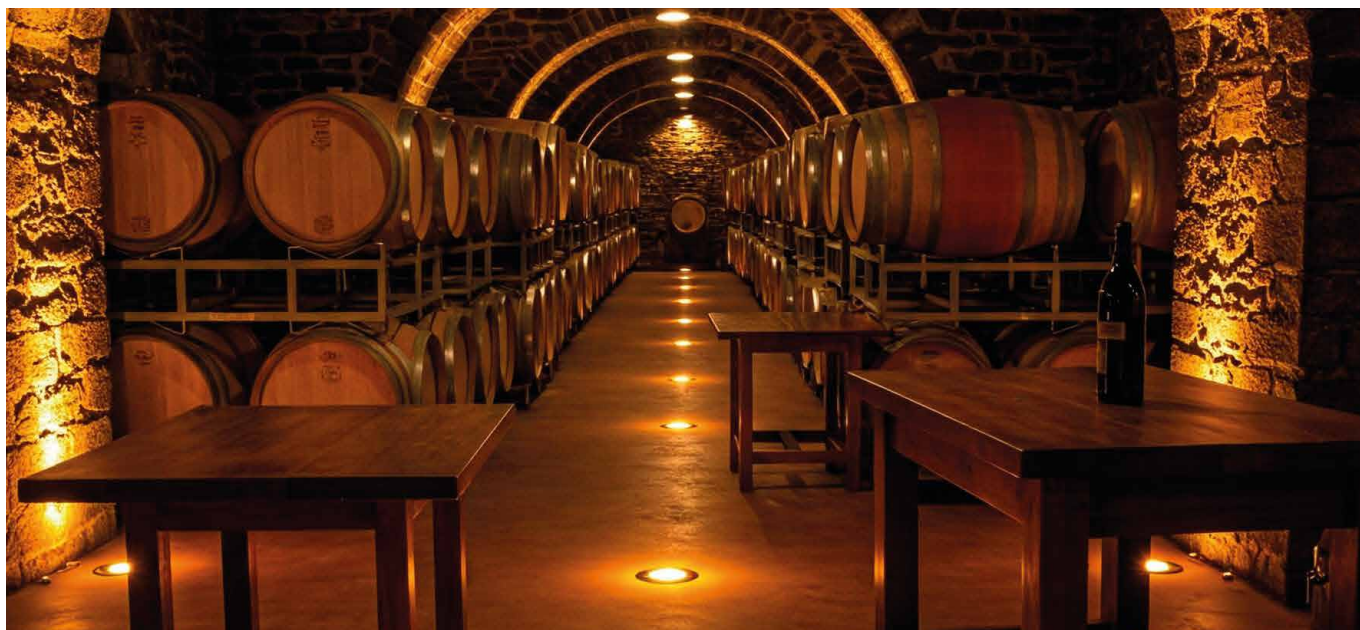

Incasso in acciaio 304 tornito con LED di potenza per illuminazione primaria a pavimento di aree verdi e facciate architettoniche. Ottica secondaria a scelta. Installabile ad incasso in ambienti interni ed esterni. Montaggio con cassaforma o anello con molle.

Power LED CRI>80

Potenza: 3,2W@350mA - 4,8W@500mA

Lumen: 200Lm@350mA - 280Lm@500mA

Alimentazione in corrente costante 350mA - 500mA

Collegamento in serie, cavo cm 50





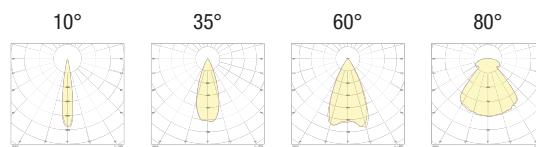
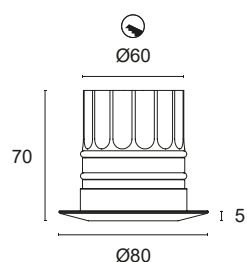

 **PRODOTTO IN ITALIA**



**CODICI BASE**

**L601.**

**FASCIO LUCE**

-  **10** 10°
-  **35** 35°
-  **60** 60°
-  **80** 80°

**VETRO**

-  **T** Trasparente
-  **S** Sabbaiato

**COLORE LED**

-  **AM** Ambra "vino"
-  Approvato CIVIC

**POTENZA**

- 3** 4x0,8W - 350mA - 200 lm
- 5** 4x1,2W - 500mA - 280 lm

**Esempio di codifica:**

ACSO 1 + Fascio di luce 35° + Vetro trasparente + Ambra "vino" + 3,2W = Codice: L601.35TAM3

# ACSO 2

## L602.

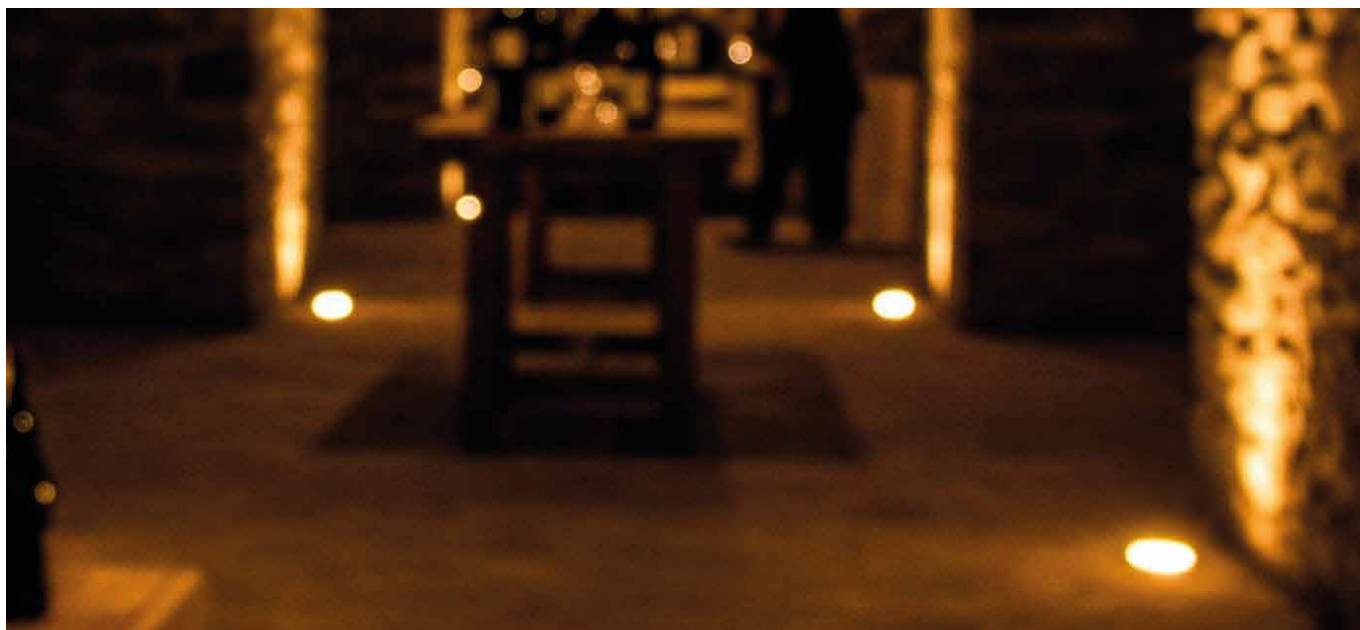

Incasso in acciaio 304 tornito con LED di potenza per illuminazione d'accento e segna passo. Diffusore opalino. Installabile a pavimento o a parete in ambienti interni ed esterni, montaggio con cassaforma.

Power LED CRI>80

Potenza: 3,2W@350mA - 4,8W@500mA

Lumen: 200Lm@350mA - 280Lm@500mA

Alimentazione in corrente costante 350mA - 500mA

Collegamento in serie, cavo cm 50



 **PRODOTTO IN ITALIA**

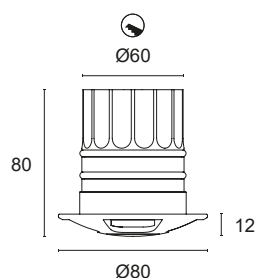

CODICI BASE

**L602.**

FASCIO LUCE

 **R4** Radiale 4 aperture

COLORE LED

 **AM** Ambra "vino"



POTENZA

**3** 4x0,8W - 350mA - 200 lm

**5** 4x1,2W - 500mA - 280 lm

Esempio di codifica:

ACSO 2 + Fascio di luce radiale 4 aperture + Ambra "vino" + 3,2W = Codice: L602.R4AM3

# ACSO 3

## L603.



Incasso in acciaio 304 tornito con LED di potenza per illuminazione d'accento o segna passo. Ottica asimmetrica. Installabile a pavimento in ambienti interni ed esterni, montaggio con cassaforma.

Power LED CRI>80

Potenza: 0,8W@350mA - 1,2W@500mA

Lumen: 50Lm@350mA - 70Lm@500mA

Alimentazione in corrente costante 350mA - 500mA

Collegamento in serie, cavo cm 50

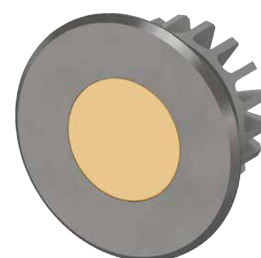

 **PRODOTTO IN ITALIA**

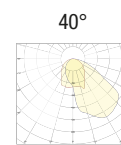
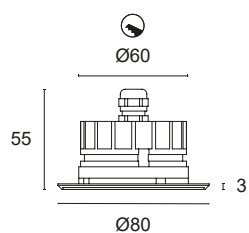

**CODICI BASE**

**L603.**

**FASCIO LUCE**

 **40** 40° Asimmetrica

**VETRO**

 **T** Trasparente

**COLORE LED**

 **AM** Ambra "vino"

 Approvato  
CIVIC

**POTENZA**

**3** 1x0,8W - 350mA - 50 lm

**5** 1x1,2W - 500mA - 70 lm

**Esempio di codifica:**

ACSO 3 + Fascio di luce 40° + Vetro trasparente + Ambra "vino" + 0,8W = Codice: **L603.40TAM3**







## PROIETTORI

DUVAR .....	46
VERTIGO .....	47
ZEPPELIN .....	48

# DUVAR

## L23.

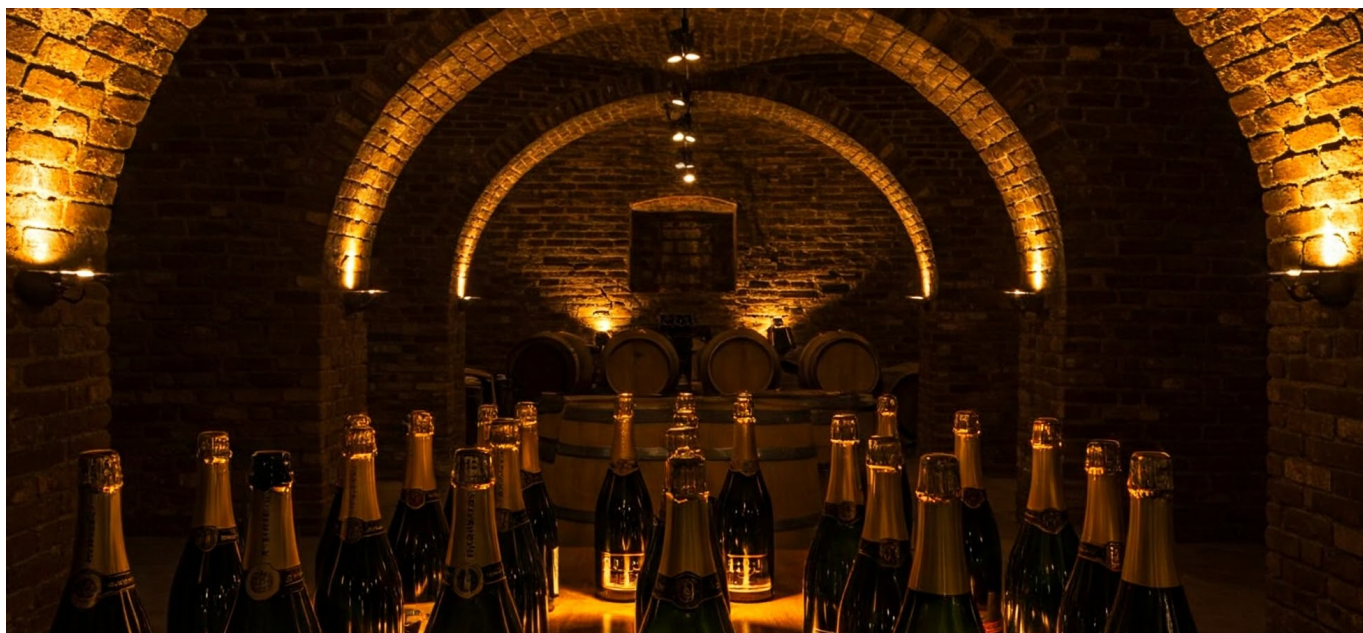

Proiettore orientabile in alluminio anodizzato anticorrosivo o decorato con sorgente LED di potenza. Adatto per illuminazione decorativa, d'accento, cortesia ed illuminotecnica in genere. Ottica secondaria a scelta, installabile in ambienti interni ed esterni. Montaggio a vite con base o su picchetto.

Power LED CRI>80

Potenza: 2,4W@350mA - 3,6W@500mA

Lumen: 150Lm@350mA - 210Lm@500mA

Alimentazione in corrente costante 350mA - 500mA

Collegamento in serie, cavo cm 50



 **PRODOTTO IN ITALIA**

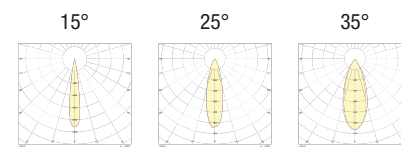
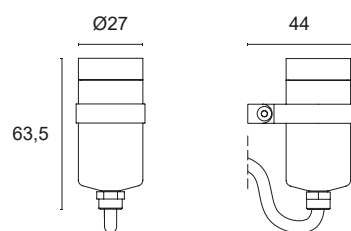

**CODICI BASE**

**L23.**

**FINITURE**

- 2** Nero opaco
- 7** Alluminio satinato

**FASCIO LUCE**

- 15** 15°
- 25** 25°
- 35** 35°

**COLORE LED**

- AM** Ambra "vino"
-  **Approvato CIVIC**

**POTENZA**

- 3** 3x0,8W - 350mA - 150 lm
- 5** 3x1,2W - 500mA - 210 lm

**Esempio di codifica:**

DUVAR + Alluminio satinato + Fascio di luce 15° + Ambra "vino" + 2,4W = Codice: L23.715AM3

# VERTIGO

## L14.

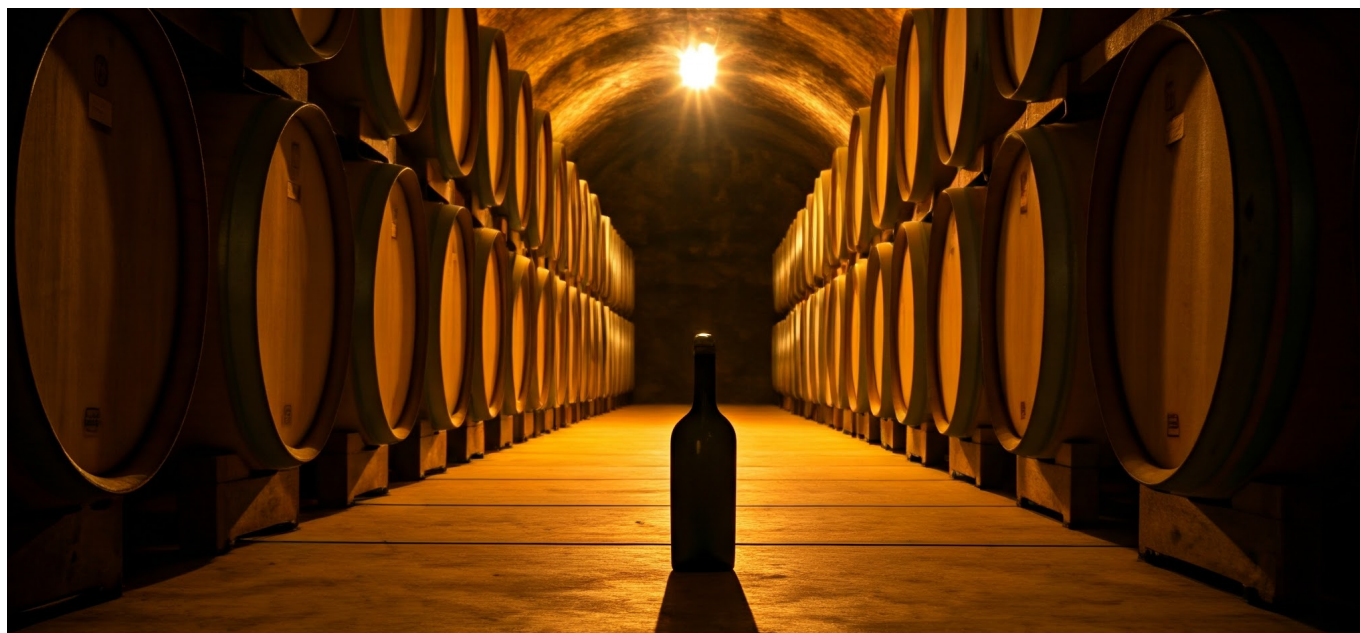

Proiettore orientabile in alluminio anodizzato anticorrosivo o decorato con LED di potenza. Adatto per illuminazione primaria e decorativa di facciate architettoniche, giardini e monumenti. Ottica secondaria a scelta, installabile in ambienti interni ed esterni. Montaggio a vite su staffa.

Power LED CRI>80

Potenza: 3,2W@350mA - 4,8W@500mA

Lumen: 200Lm@350mA - 280Lm@500mA

Alimentazione in corrente costante 350mA - 500mA

Collegamento in serie, cavo cm 50



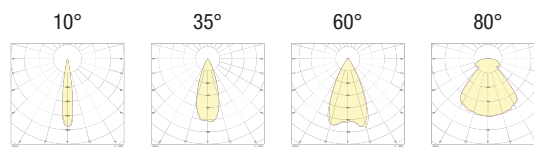
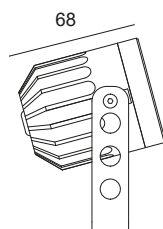
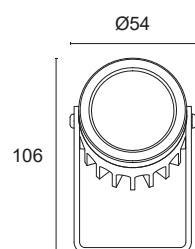

 **PRODOTTO IN ITALIA**







**CODICI BASE**

**L14.**

**FINITURE**

-  **2** Nero opaco
-  **7** Alluminio satinato

**FASCIO LUCE**

-  **10** 10°
-  **35** 35°
-  **60** 60°
-  **80** 80°

**COLORE LED**

-  **AM** Ambra "vino"
-  Approvato CIVIC

**POTENZA**

- 3** 4x0,8W - 350mA - 200 lm
- 5** 4x1,2W - 500mA - 280 lm

**Esempio di codifica:**

VERTIGO + Alluminio satinato + Fascio di luce 10° + Ambra "vino" + 3,2W = Codice: L14.710AM3

# ZEPPELIN

## L06.

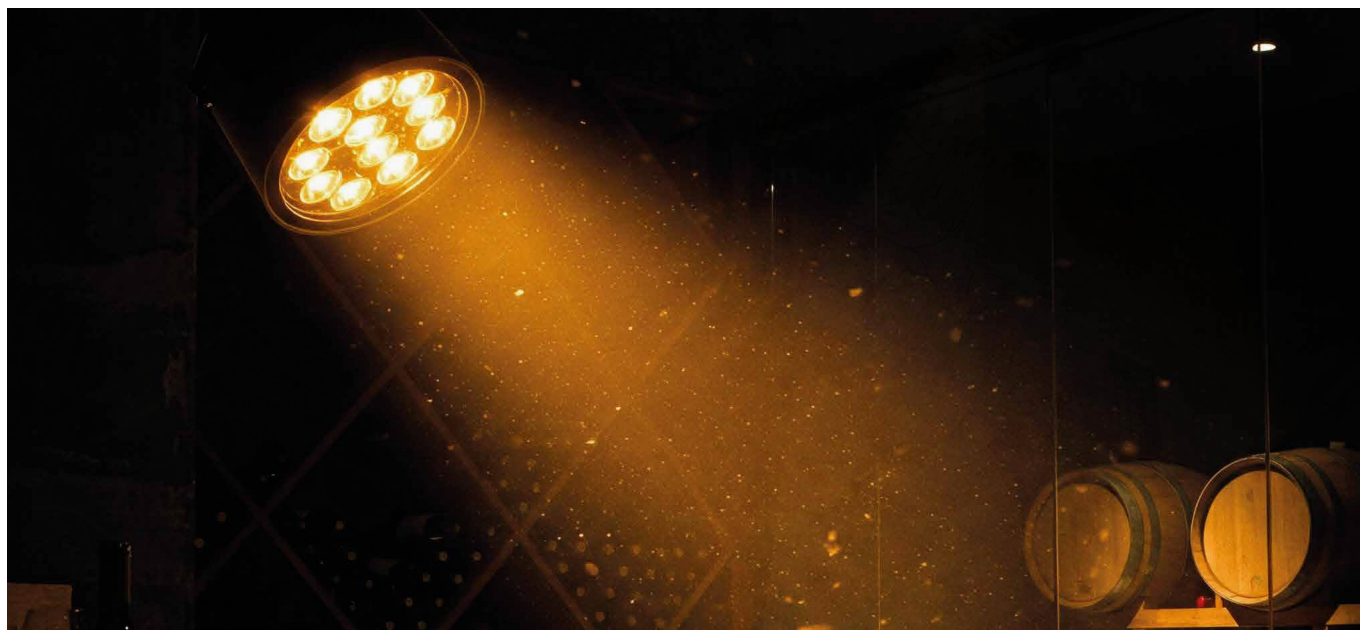

Proiettore orientabile in alluminio anodizzato anticorrosivo o decorato con sorgente LED di potenza. Adatto per illuminazione primaria e decorativa di facciate architettoniche, giardini e monumenti. Ottica secondaria a scelta, installabile in ambienti interni ed esterni. Montaggio a vite su staffa.

Power LED CRI>80

Potenza: 7,2W@350mA - 10,8W@500mA

Lumen: 450Lm@350mA - 630Lm@500mA

Alimentazione in corrente costante 350mA - 500mA

Collegamento in serie, cavo cm 50

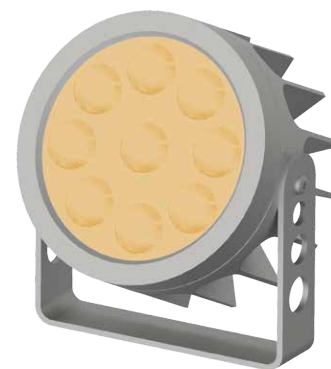

 **PRODOTTO IN ITALIA**

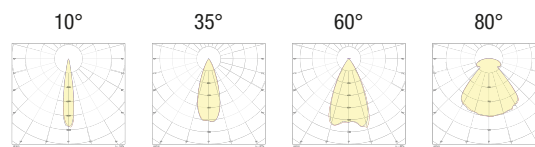
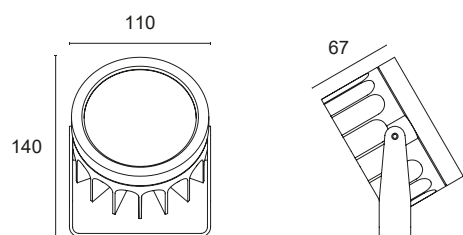

**CODICI BASE**

**L06.**

**FINITURE**

- **2** Nero opaco
- **7** Alluminio satinato

**FASCIO LUCE**

- **10** 10°
- **35** 35°
- **60** 60°
- **80** 80°

**COLORE LED**

- **AM** Ambra "vino"
-  Approvato CIVIC

**POTENZA**

- **3** 9x0,8W - 350mA - 450 lm
- **5** 9x1,2W - 500mA - 630 lm

Esempio di codifica:

ZEPPELIN + Nero opaco + Fascio di luce 10° + Ambra "vino" + 7,2W = Codice: L06.210AM3







## **ILLUMINAZIONE TECNICO DECORATIVO**

<b>PIXEL 1</b>	52
<b>EVA</b>	53
<b>REM</b>	54
<b>CISO PLAFONE P31</b>	55
<b>CISO PLAFONE P33</b>	56
<b>CISO SOSPENSIONE S31</b>	57
<b>CISO SOSPENSIONE S33</b>	58
<b>ROSONI PER ALTRE COMPOSIZIONI CISO</b>	59



# PIXEL 1

## F10.



Lampada orientabile in alluminio tornito e flessibile indicata per illuminazione da lettura, decorazione o cortesia. Ottica secondaria a scelta, installabile in ambienti interni. Montaggio a vite con base o a parete.

Power LED CRI>80

Potenza: 0,8W@350mA

Lumen: 50Lm@350mA

Alimentazione in corrente costante 350mA

Alimentatore in corrente costante incluso

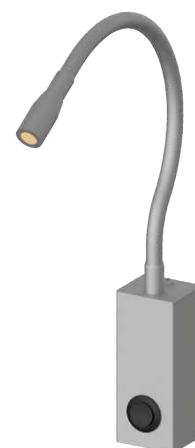

 **PRODOTTO IN ITALIA**



**F10.** base c/box

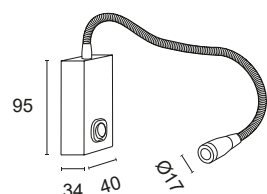

**F10.** base piatta

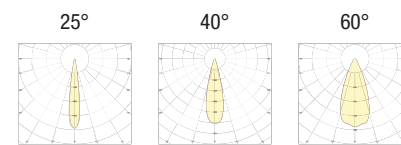
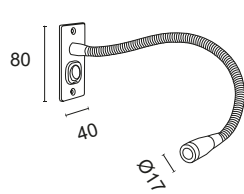



**CODICI BASE**

**F10.**

**FINITURE**

-  **6** Cromo
-  **7** Alluminio satinato

**FASCIO LUCE**

-  **25** 25°
-  **40** 40°
-  **60** 60°

**COLORE LED**

-  **AM** Ambrato "vino"
-  Approvato CIVIC

**BASE C/BOX E INTERRUTTORE**

- BX** senza interruttore
- BB** con interruttore bianco
- BN** con interruttore nero

**BASE PIATTA E INTERRUTTORE**

- PX** senza interruttore
- PB** con interruttore bianco
- PN** con interruttore nero

Esempio di codifica:

PIXEL 1 + Alluminio satinato + Fascio luce 25° + Ambrato "vino" + Base piatta interruttore bianco = Codice: F10.725AMPB



# EVA

## L33.

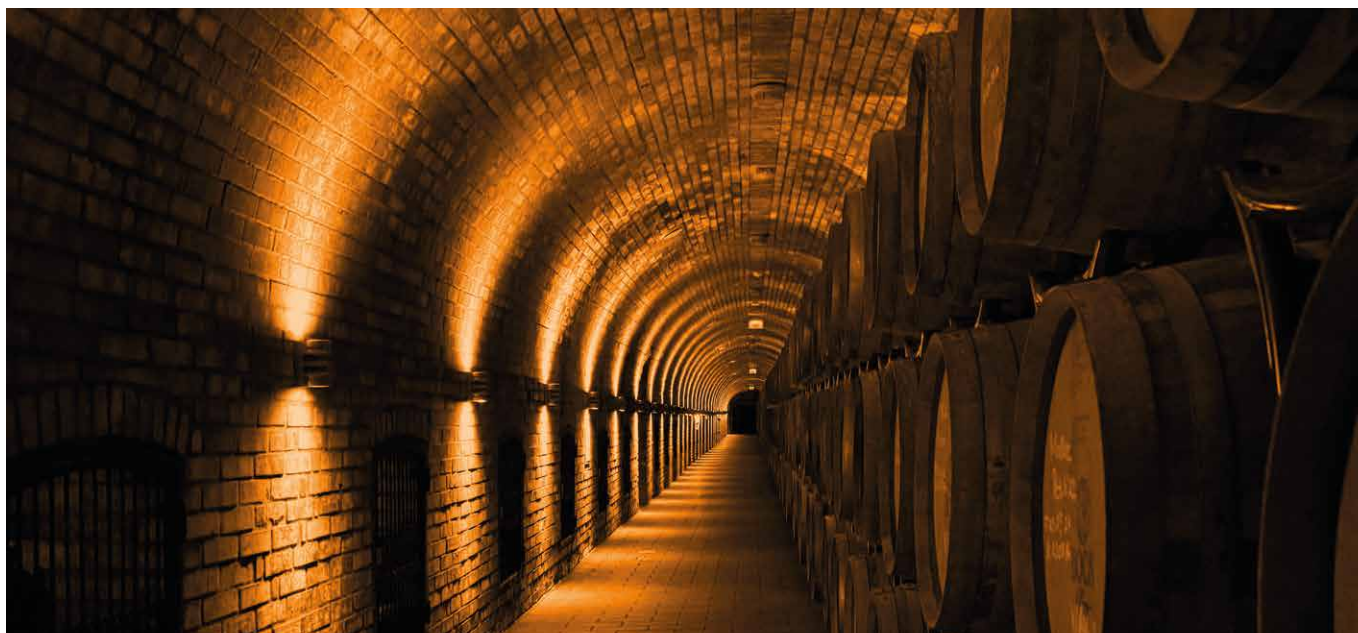

Lampada biemissione in alluminio tornito indicata per illuminazione d'accento, decorazione e cortesia. Ottica secondaria a scelta, installabile in ambienti interni ed esterni. Montaggio a vite con base a parete.

Power LED CRI>80

Potenza: 1,2W+1,2W@500mA

Lumen: 70+70Lm@500mA

Alimentazione in corrente costante 500mA

Alimentatore incluso e integrato.

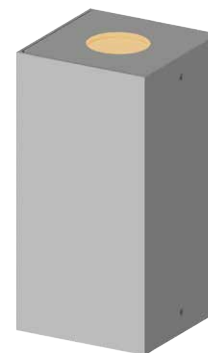

 **PRODOTTO IN ITALIA**

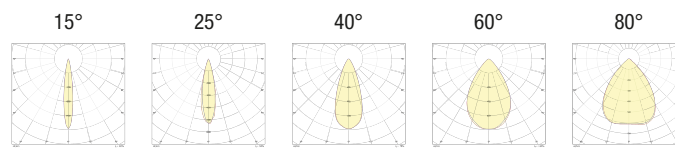
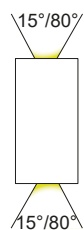
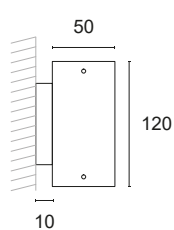

**CODICI BASE**

**L33.**

**FINITURE**

- 1 Bianco
- 2 Nero opaco
- 7 Alluminio satinato

**1° FASCIO LUCE**

- 15 15°
- 25 25°
- 40 40°
- 60 60°
- 80 80°

**2° FASCIO LUCE**

- 15 15°
- 25 25°
- 40 40°
- 60 60°
- 80 80°

**COLORE LED**

- AM** Ambra "vino"
- Approvato CIVIC

**Esempio di codifica:**

EVA + Nero opaco + 1°fascio di luce 15°+ 2°fascio di luce 40°+ Ambra "vino" = Codice: L33.21540AM

# REM RG32.

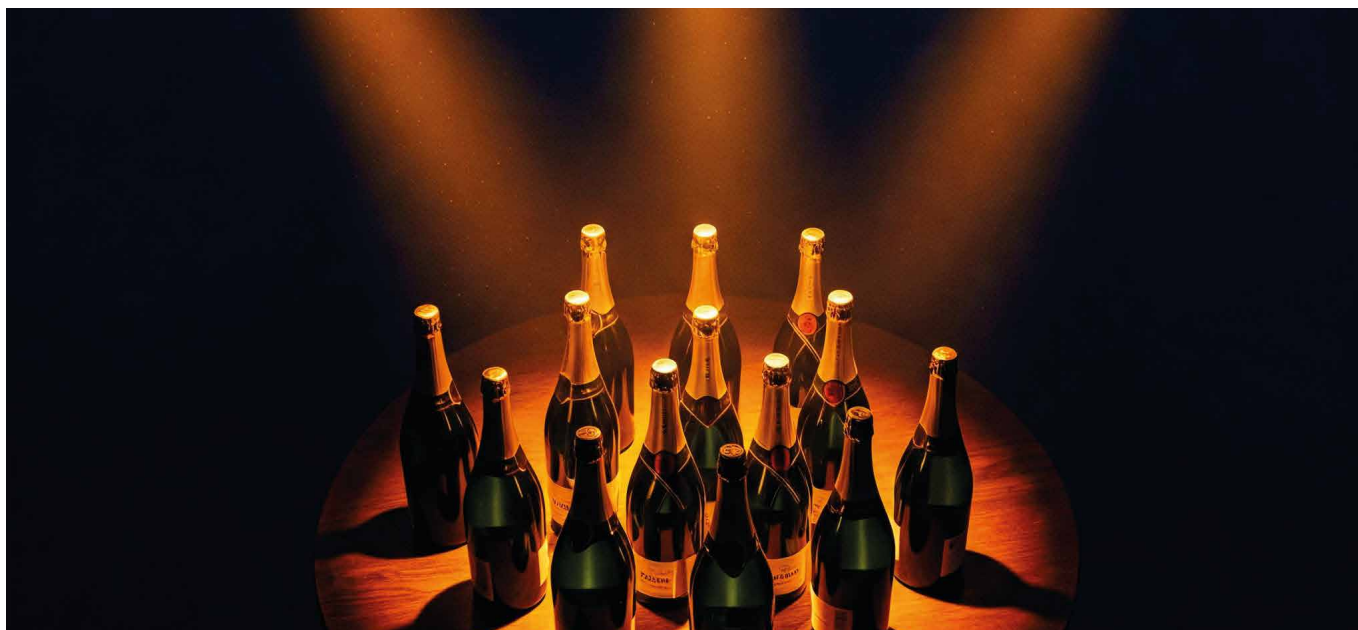

Proiettore Ø32mm orientabile in alluminio decorato con LED di potenza, indicato per illuminazione puntuale di decorazione, lettura e cortesia. Ottica secondaria a scelta, installabile in ambienti interni. Montaggio con inserto a scomparsa.

Power LED CRI>80

Potenza: 1,2W@500mA - 3,6W@500mA

Lumen: 70Lm@500mA - 210Lm@500mA

Alimentazione in corrente costante 500mA

Collegamento in serie, cavo cm 50



 **PRODOTTO IN ITALIA**

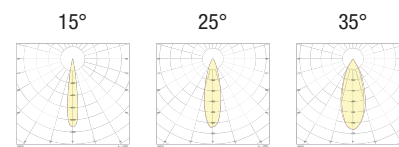
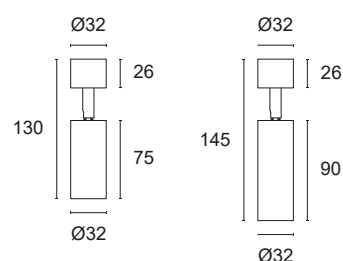

**CODICI BASE**

**RG32.**

**DIMENSIONI**

**A** Ø32 - H 130mm

**B** Ø32 - H 145mm

**FINITURE**

- 1** Bianco
- 2** Nero opaco
- 7** Alluminio satinato
- 9** Oro lucido

**FASCIO LUCE**

- 15** 15°
- 25** 25°
- 35** 35°

**COLORE LED**

- AM** Ambra "vino"
-  Approvato CIVIC

**POTENZA**

- 3** 1x1,2W  
500mA - 50 lm
- 5** 3x1,2W  
500mA - 210 lm

**Esempio di codifica:**

REM + H130mm + Bianco + Fascio di luce 15° + Ambra "vino" + 1,2W = Codice: RG32.A115AM3

# CISO PLAFONE P31

P31.

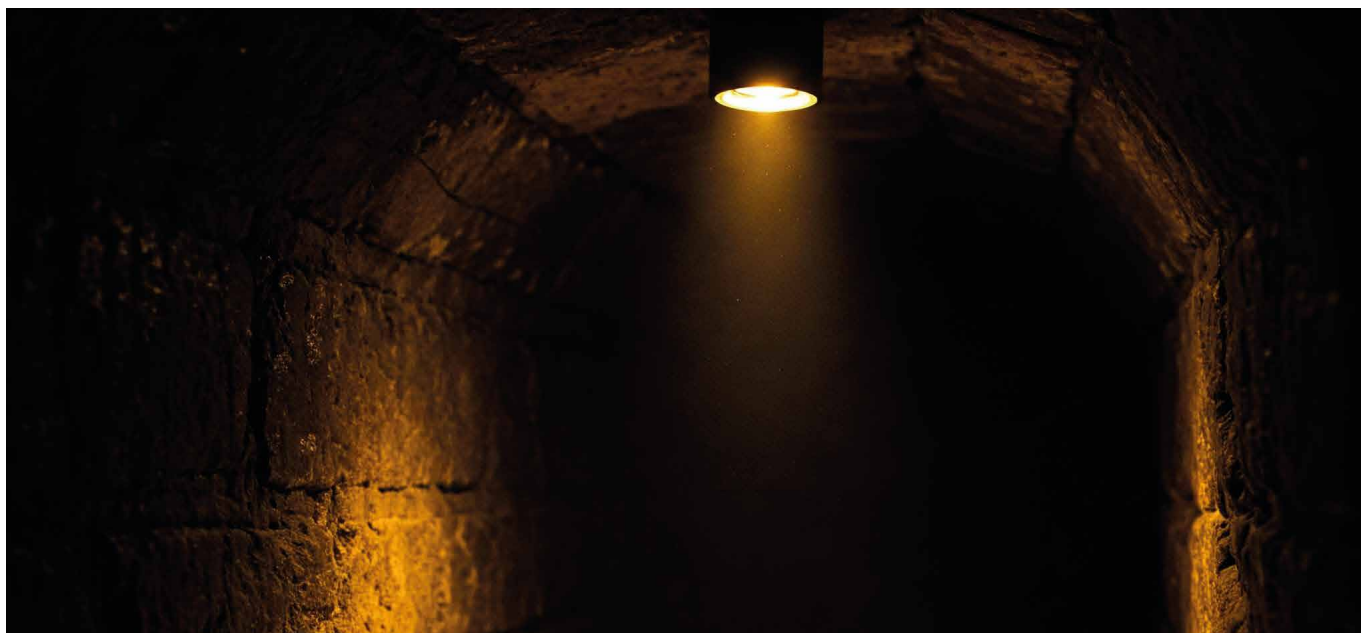

Plafone a cilindro Ø32mm in alluminio decorato con un LED di potenza, indicato come illuminazione d'accento e risalto per ambienti residenziali, ristorazione o retail. Ottica secondaria recessa a scelta, installabile in ambienti interni. Montaggio con base a scomparsa.

Power LED CRI>80

Potenza: 1,2W@500mA

Lumen: 70Lm@500mA

Alimentazione in corrente costante 500mA

Alimentatore incluso e remoto



 **PRODOTTO IN ITALIA**

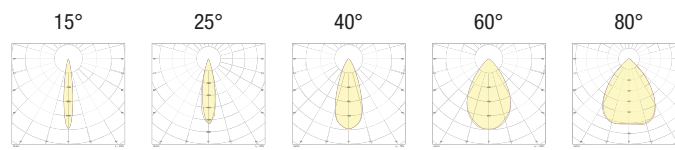

## CODICI BASE

**P31.**





## DIMENSIONE

- A** H 90mm
- B** H 180mm
- C** H 290mm
- D** H 470mm
- E** H 760mm

## FINITURE

-  **1** Bianco
-  **2** Nero opaco
-  **5** Alluminio brillante
-  **7** Alluminio satinato
-  **8** Foglia oro
-  **9** Rame Bond

## FASCIO LUCE

-  **15** 15°
-  **25** 25°
-  **40** 40°
-  **60** 60°
-  **80** 80°

## COLORE LED

-  **AM** Ambra "vino"
-  Approvato CIVIC

Esempio di codifica:

CISO PLAFONE P31 + H470mm + Bianco + Fascio di luce 15° + Ambra "vino" = Codice: P31.D115AM

# CISO PLAFONE P33

P33.



Plafone a cilindro Ø32mm in alluminio decorato con tre LED di potenza, indicato come illuminazione d'accento e risalto per ambienti residenziali, ristorazione o retail. Ottica secondaria recessa a scelta, installabile in ambienti interni. Montaggio con base a scomparsa.

Power LED CRI>80

Potenza: 3,6W@500mA

Lumen: 210Lm@500mA

Alimentazione in corrente costante 500mA

Alimentatore incluso e remoto



 **PRODOTTO IN ITALIA**

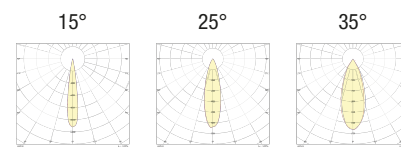

## CODICI BASE

**P33.**

## DIMENSIONE

- A** H 90mm
- B** H 180mm
- C** H 290mm
- D** H 470mm
- E** H 760mm

## FINITURE

- 1** Bianco
- 2** Nero opaco
- 5** Alluminio brillante
- 7** Alluminio satinato
- 8** Foglia oro
- 9** Rame Bond

## FASCIO LUCE

- 15** 15°
- 25** 25°
- 35** 35°

## COLORE LED

- AM** Ambra "vino"
-  Approvato CIVIC

Esempio di codifica:

CISO PLAFONE P33 + H470mm + Bianco + Fascio di luce 15° + Ambra "vino" = Codice: P33.D115AM



# CISO SOSPENSIONE S31

S31.



Sospensione a cilindro Ø32mm in alluminio decorato con un LED di potenza, indicato come illuminazione d'accento e risalto per ambienti residenziali, ristorazione o retail. Ottica secondaria recessa a scelta, installabile in ambienti interni. Montaggio con rosone a vite, cavo 2000mm, finitura a scelta.

Power LED CRI>80  
Potenza: 1,2W@500mA  
Lumen: 70Lm@500mA  
Alimentazione in corrente costante 500mA  
Alimentatore incluso e integrato



 **PRODOTTO IN ITALIA**

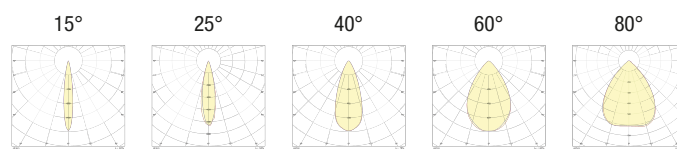
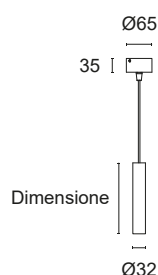

**CODICI BASE**

**S31.**

**DIMENSIONE**

- A** H 90mm
- B** H 180mm
- C** H 290mm
- D** H 470mm
- E** H 760mm

**FINITURE**

- 1** Bianco
- 2** Nero opaco
- 5** Alluminio brillante
- 7** Alluminio satinato
- 8** Foglia oro
- 9** Rame Bond

**FASCIO LUCE**

- 15** 15°
- 25** 25°
- 40** 40°
- 60** 60°
- 80** 80°

**COLORE LED**

- AM** Ambra "vino"
-  Approvato CIVIC

**CAVO**

- T** Trasparente
- B** Bianco
- N** Nero
- R** Rosso

**Esempio di codifica:**

CISO SOSPENSIONE S31 + H470mm + Bianco + Fascio di luce 15° + Ambra "vino" + Cavo Tessuto nero = Codice: S31.D115AMN

# CISO SOSPENSIONE S33

S33.

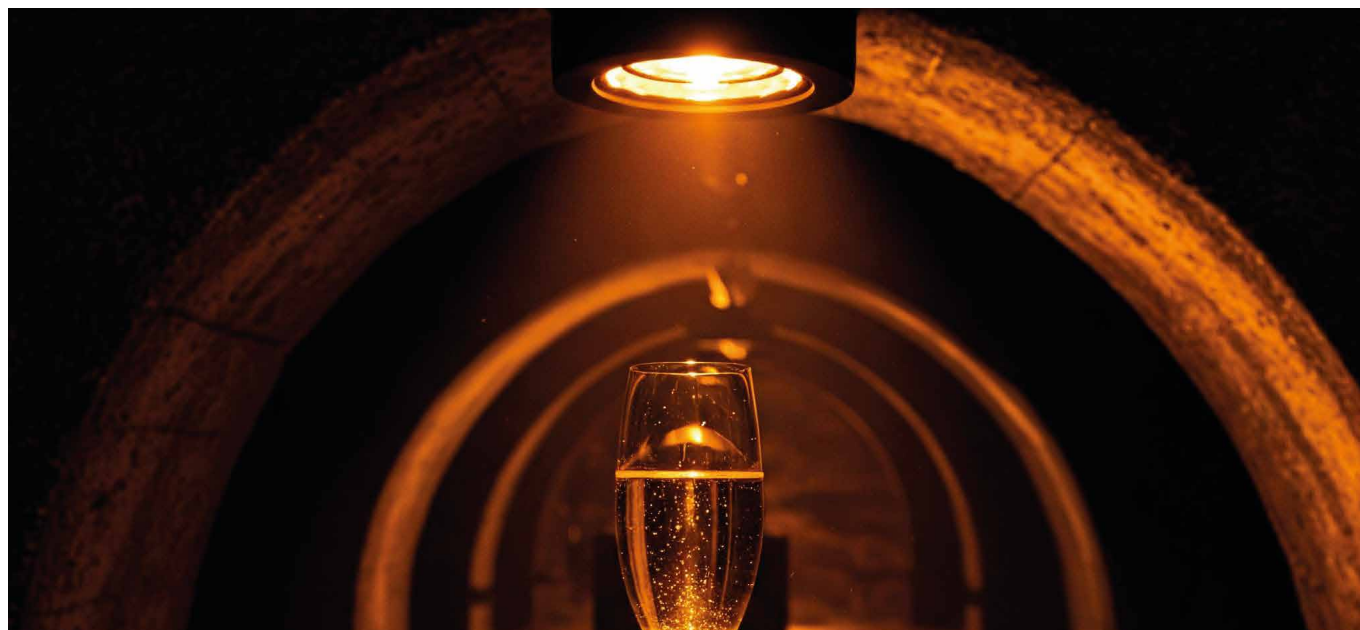

Sospensione a cilindro Ø32mm in alluminio decorato con tre LED di potenza, indicato come illuminazione d'accento e risalto per ambienti residenziali, ristorazione o retail. Ottica secondaria recessa a scelta, installabile in ambienti interni. Montaggio con rosone a vite, cavo 2000mm, finitura a scelta.

Power LED CRI>80

Potenza: 3,6W@500mA

Lumen: 210Lm@500mA

Alimentazione in corrente costante 500mA

Alimentatore incluso e integrato



 **PRODOTTO IN ITALIA**

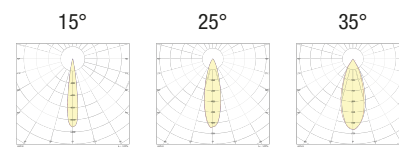
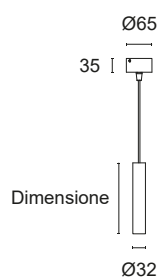

**CODICI BASE**

**S33.**

**DIMENSIONE**

- A** H 90mm
- B** H 180mm
- C** H 290mm
- D** H 470mm
- E** H 760mm

**FINITURE**

- 1** Bianco
- 2** Nero opaco
- 5** Alluminio brillante
- 7** Alluminio satinato
- 8** Foglia oro
- 9** Rame Bond

**FASCIO LUCE**

- 15** 15°
- 25** 25°
- 35** 35°

**COLORE LED**

- AM** Ambra "vino"
-  Approvato CIVIC

**CAVO**

- T** Trasparente
- B** Bianco
- N** Nero
- R** Rosso

**Esempio di codifica:**

CISO SOSPENSIONE S33 + H470mm + Bianco + Fascio di luce 35° + Ambra "vino" + Cavo Tessuto nero = Codice: **S33.D135AMN**

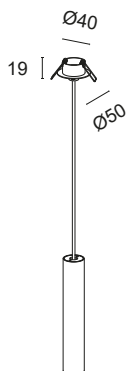

CODICI BASE

**S31.F1.**

FINITURE

- 1 Bianco
- 2 Nero opaco
- 5 Alluminio brillante
- 7 Alluminio satinato
- 8 Foglia oro
- 9 Rame Bond

Rosone da Ø50mm in alluminio decorato per fissaggio delle **sospensioni CISO S31, S33** su cartongesso. Montaggio ad incasso con molle.

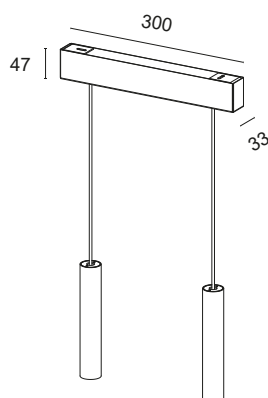

CODICI BASE

**RM0300.**

FINITURE

- 1 Bianco
- 2 Nero opaco
- 7 Alluminio satinato
- 8 Foglia oro
- 9 Rame Bond

Rosone da 300mm in metallo decorato per composizioni delle **sospensioni CISO S31, S33**. Contiene l'alimentatore per singolo cilindro. Montaggio con staffa con viti a scomparsa e rosone magnetico. N.B. Forature e quantità di sospensioni da definire in fase di ordine.

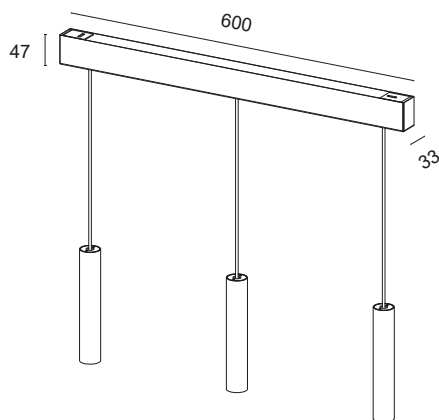

CODICI BASE

**RM0600.**

FINITURE

- 1 Bianco
- 2 Nero opaco
- 7 Alluminio satinato
- 8 Foglia oro
- 9 Rame Bond

Rosone da 600mm in metallo decorato per composizioni delle **sospensioni CISO S31, S33**. Contiene l'alimentatore per singolo cilindro. Montaggio con staffa con viti a scomparsa e rosone magnetico. N.B. Forature e quantità di sospensioni da definire in fase di ordine.

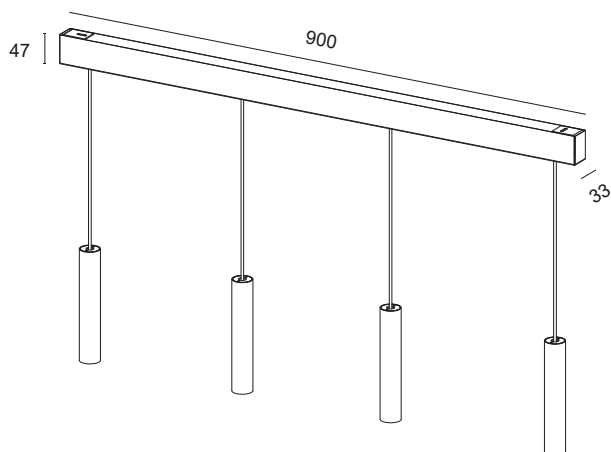

CODICI BASE

**RM0900.**

FINITURE

- 1 Bianco
- 2 Nero opaco
- 7 Alluminio satinato
- 8 Foglia oro
- 9 Rame Bond

Rosone da 900mm in metallo decorato per composizioni delle **sospensioni CISO S31, S33**. Contiene l'alimentatore per singolo cilindro. Montaggio con staffa con viti a scomparsa e rosone magnetico. N.B. Forature e quantità di sospensioni da definire in fase di ordine.

Esempio di codifica:  
Rosone da 300mm + Bianco = Codice: **RM0300.1**







## ACCESSORI DI INSTALLAZIONE

CASSAFORMA HOLLY, HALISSA E MEMO .....	62
CASSAFORMA SERIE ACSO .....	62
ANELLO SERIE ACSO .....	62
CASSAFORMA SERIE DEHO E DARDO .....	63
ANELLO SERIE DEHO E DARDO .....	63
BASE E PICCHETTO DUVAR .....	63

# CASSAFORMA HOLLY, HALISSA E MEMO

Cassaforma in termoplastico per i modelli della serie HOLLY, HALISSA e MEMO da utilizzare durante la messa in opera. Installabile a parete o pavimento in laterizio. Necessaria per una corretta installazione.

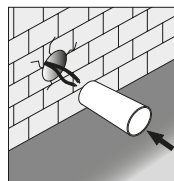
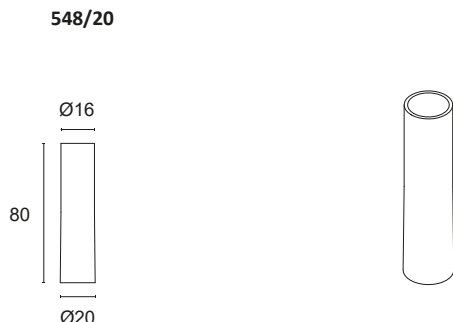

Posizionare la cassaforma a filo parete o pavimento.

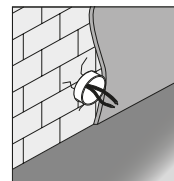

Fissare la cassaforma con colla o stucco e rasare a filo parete o pavimento. Evitare che corpi estranei entrino all'interno della cassaforma.

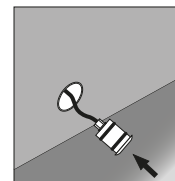

Eseguire il collegamento elettrico come previsto dalla scheda del prodotto e verificarne il corretto funzionamento. Inserire il prodotto nella cassaforma con una leggera pressione.

# CASSAFORMA SERIE ACSO

Cassaforma in termoplastico per i modelli della serie ACSO da utilizzare durante la messa in opera. Installabile a parete o pavimento in laterizio. Necessaria per una corretta installazione.

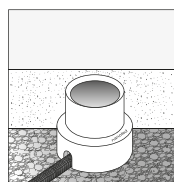
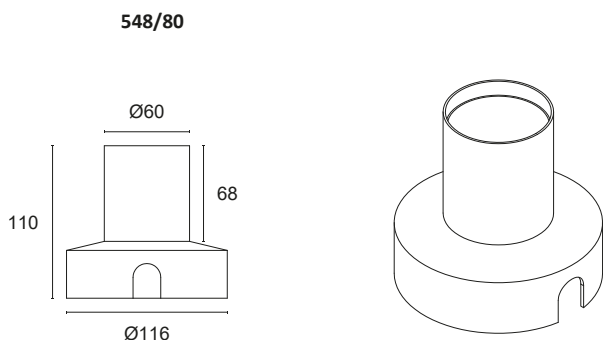

Posizionare la cassaforma con la parte superiore a filo parete o pavimento. Applicare il tappo in dotazione per evitare che corpi estranei entrino all'interno. Prevedere un adeguato drenaggio sotto la cassaforma.

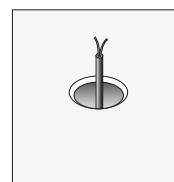

Controllare che la cassaforma non si muova durante la posa del massetto. Effettuare il passaggio del cavo elettrico dalla cassaforma al pozzetto. Richiudere la cassaforma con il tappo in dotazione.

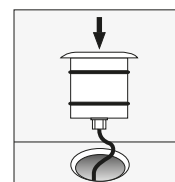

Dopo la rasatura rimuovere il tappo ed eseguire il collegamento elettrico come previsto dalla scheda del prodotto, verificarne il corretto funzionamento ed inserirlo nella cassaforma con una leggera pressione.

# ANELLO SERIE ACSO

Anello in alluminio per i modelli della serie ACSO da utilizzare durante la messa in opera ad incasso in cartongesso.

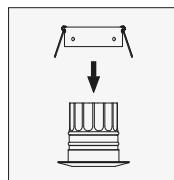
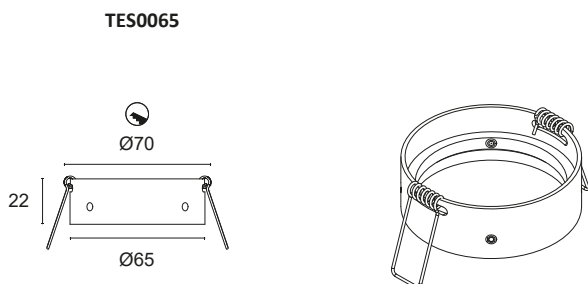

Posizionare l'anello nel faretto.

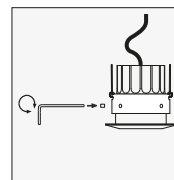

Fissare l'anello con i grani in dotazione.

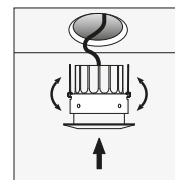

Forare il cartongesso della misura indicata ed inserire il faretto nel foro.

# CASSAFORMA SERIE DEHO E DARDO

Cassaforma in termoplastico per i modelli della serie DEHO e DARDO da utilizzare durante la messa in opera. Installabile a parete o pavimento in laterizio. Necessaria per una corretta installazione.

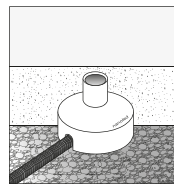
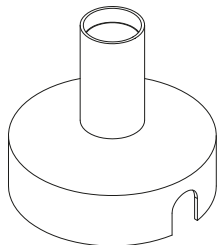
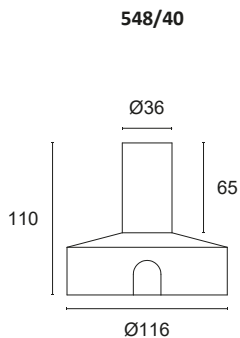

Posizionare la cassaforma con la parte superiore a filo parete o pavimento. Applicare il tappo in dotazione per evitare che corpi estranei entrino all'interno. Prevedere un adeguato drenaggio sotto la cassaforma.

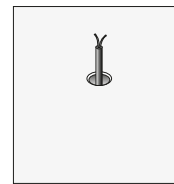

Controllare che la cassaforma non si muova durante la posa del massetto. Effettuare il passaggio del cavo elettrico dalla cassaforma al pozzetto. Richiudere la cassaforma con il tappo in dotazione.

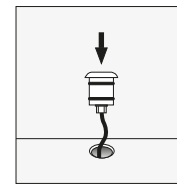

Dopo la rasatura rimuovere il tappo ed eseguire il collegamento elettrico come previsto dalla scheda del prodotto, verificarne il corretto funzionamento ed inserirlo nella cassaforma con una leggera pressione.

# ANELLO SERIE DEHO E DARDO

Anello in alluminio per i modelli della serie DEHO e DARDO da utilizzare durante la messa in opera ad incasso in cartongesso.

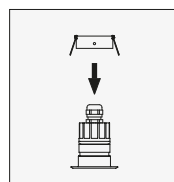
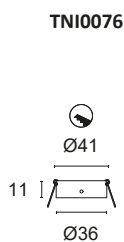

Posizionare l'anello nel faretto.

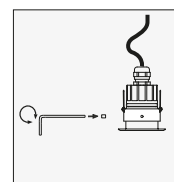

Fissare l'anello con i grani in dotazione.

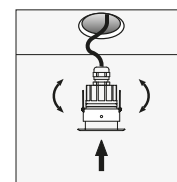

Forare il cartongesso della misura indicata ed inserire il faretto nel foro.

# BASE E PICCHETTO DUVAR

Sistemi di fissaggio per proiettore DUVAR, necessari per una corretta messa in opera.

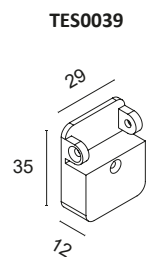

Base di fissaggio

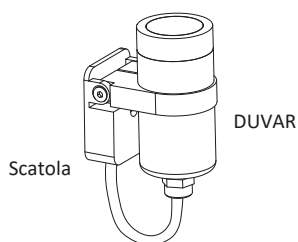

PDH235

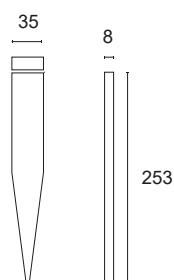

Picchetto di fissaggio

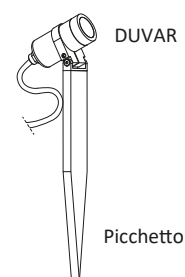







## **NANOLED LIGHTING**

È un brand di Tecnocavi Service srl  
61021 Carpegna (PU) via Pian dei Roghi, 32  
Tel. + 39 0722 77418  
[www.nanoledlighting.com](http://www.nanoledlighting.com)

## **CONTATTI**

### **Ufficio informazioni**

[info@nanoledlighting.com](mailto:info@nanoledlighting.com)

### **Federico Francioni**

Titolare e Responsabile commerciale  
[federico@nanoledlighting.com](mailto:federico@nanoledlighting.com)

### **Francesco Francioni Jr.**

Commerciale Italia  
[commerciale@nanoledlighting.com](mailto:commerciale@nanoledlighting.com)

### **Fabrizio Francioni**

Titolare e Responsabile produzione e Approvvigionamento  
[fabrizio@nanoledlighting.com](mailto:fabrizio@nanoledlighting.com)

### **Francesco Francioni**

Titolare e Direzione generale  
[francesco@nanoledlighting.com](mailto:francesco@nanoledlighting.com)

### **Francesca Severi**

Responsabile Amministrazione  
[amministrazione@nanoledlighting.com](mailto:amministrazione@nanoledlighting.com)

### **Remo Giuliani**

Ufficio tecnico e design  
[tecnico@nanoledlighting.com](mailto:tecnico@nanoledlighting.com)

## **CATALOGO COLLEZIONE VINO E CHAMPAGNE Ed. 01**

Progettazione e realizzazione grafica: Team Nanoled Lighting



nanoled  
LIGHTING